



Quick Product Selection

Welcome to our catalogue 2020 with a lot of new products and a new structure which quickly leads you to the appropriate product solution.

Lightning Protection / Earthing

Catalogue valid as of March 1, 2020



Air-termination System / Down Conductor / Isolated Lightning Protection

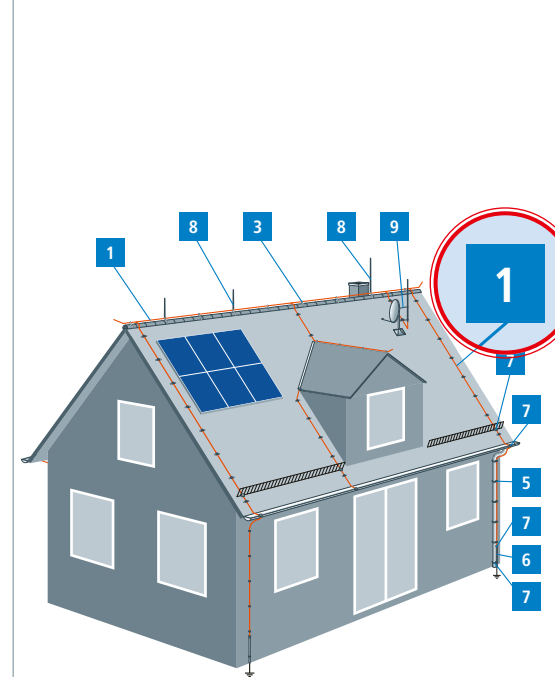

External Lightning Protection of a Residential Building

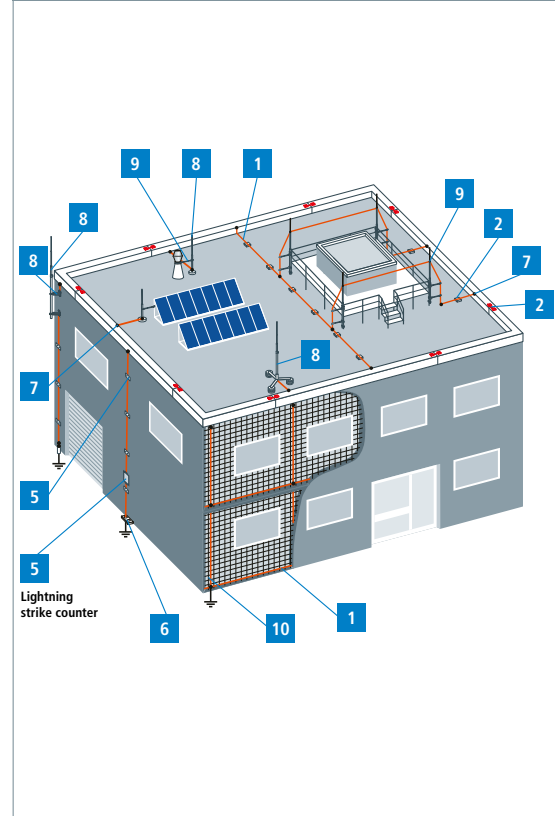

External Lightning Protection of an Industrial Building

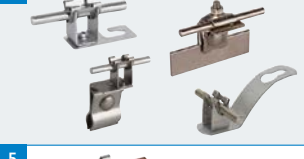
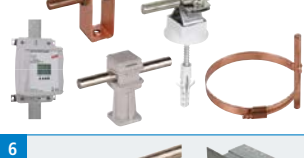

Valid as of March 1, 2020

	Product Name
<div style="border: 2px solid red; border-radius: 50%; width: 30px; height: 30px; display: flex; align-items: center; justify-content: center; margin: 0 auto;"> 1 </div> 	Pro Round Wires Strips Cables see page 19
<div style="border: 1px solid blue; border-radius: 50%; width: 15px; height: 15px; display: flex; align-items: center; justify-content: center; margin: 0 auto;"> 2 </div> 	Flat Roof – Roof Conductor Holders Bridging Braids see page 25
<div style="border: 1px solid blue; border-radius: 50%; width: 15px; height: 15px; display: flex; align-items: center; justify-content: center; margin: 0 auto;"> 3 </div> 	Gable Roof – Roof Conductor Holders see page 31
<div style="border: 1px solid blue; border-radius: 50%; width: 15px; height: 15px; display: flex; align-items: center; justify-content: center; margin: 0 auto;"> 4 </div> 	Metal Roof / Corrugated Sheet Roof – Roof Conductor Holders see page 41
<div style="border: 1px solid blue; border-radius: 50%; width: 15px; height: 15px; display: flex; align-items: center; justify-content: center; margin: 0 auto;"> 5 </div> 	Down Conductor – Conductor Holders see page 45
<div style="border: 1px solid blue; border-radius: 50%; width: 15px; height: 15px; display: flex; align-items: center; justify-content: center; margin: 0 auto;"> 6 </div> 	Earth Entries Connection Lugs Test Joint Boxes Conductor Holders see page 57
<div style="border: 1px solid blue; border-radius: 50%; width: 15px; height: 15px; display: flex; align-items: center; justify-content: center; margin: 0 auto;"> 7 </div> 	Gutter Clamps Clamps Connectors see page 73
<div style="border: 1px solid blue; border-radius: 50%; width: 15px; height: 15px; display: flex; align-items: center; justify-content: center; margin: 0 auto;"> 8 </div> 	Air-Termination Rods Air-Termination Tips Accessories see page 95
<div style="border: 1px solid blue; border-radius: 50%; width: 15px; height: 15px; display: flex; align-items: center; justify-content: center; margin: 0 auto;"> 9 </div> 	Isolated Lightning Protection see page 115
<div style="border: 1px solid blue; border-radius: 50%; width: 15px; height: 15px; display: flex; align-items: center; justify-content: center; margin: 0 auto;"> 10 </div> 	Reinforcement Technology see page 129

Wind Load in Case of Isolated Air-Termination Systems According to Eurocode

As a result of global warming, extreme weather conditions are becoming increasingly common on a worldwide scale. Consequences such as high wind speeds, an increased number of storms and heavy rainfall cannot be ignored. Therefore, designers and installers face new challenges particularly with regard to wind loads. This not only affects building structures (statics of the structure), but also air-termination systems.

In the past, the DIN 1055-4:2005-03 and DIN 4131 standards formed the basis for dimensioning in the field of lightning protection. In July 2012, these standards were replaced by the Eurocodes which provide Europe-wide standardised structural design rules (planning of structures).

The DIN 1055-4:2005-03 standard was integrated in Eurocode 1 (EN 1991-1-4: Actions on structures – Part 1-4: General actions - Wind actions) and DIN V 4131:2008-09 in Eurocode 3 (EN 1993-3-1: Part 3-1: Towers, masts and chimneys – Towers and masts). Thus, these two standards form the basis for dimensioning air-termination systems for lightning protection systems, whereby Eurocode 1 is of primary relevance.

The following parameters are used to calculate the actual wind load to be expected:

- Wind zone (Germany is divided into four wind zones with different base wind speeds)
- Terrain category (the terrain categories define the surroundings of a structure)
- Height of the object above ground level
- Height of the location (above sea level)

Other influencing factors such as:

- Icing
- Position on a ridge or top of a hill
- Object height above 300 m
- Terrain height above 800 m (sea level)

have to be considered for the specific installation environment and calculated separately.

The combination of the different parameters results in the gust wind speed to be used as a basis for dimensioning air-termination systems and other installations such as elevated ring conductors. In our catalogue, the maximum gust wind speed is specified for our products to make it possible to determine the required number of concrete bases depending on the gust wind speed, for example, in case of isolated air-termination systems. Besides allowing the determination of the static stability, this also makes it possible to reduce the necessary weight and thus the roof load.

Important note:

The "maximum gust wind speeds" specified in this catalogue for the individual components were determined according to the Germany-specific calculation requirements of Eurocode 1 (DIN EN 1991-1-4/NA:2010-12) which are based on the wind zone map for Germany and the associated country-specific topographic particularities. When using products from this catalogue in other countries, the country-specific particularities and other locally applicable calculation methods, if any, described in Eurocode 1 (EN 1991-1-4) or in other locally applicable calculation regulations (outside Europe) must be observed. Consequently, the maximum gust wind speeds mentioned in this catalogue only apply to Germany and only serve as a rough orientation for other countries. The gust wind speeds have to be recalculated according to the country-specific calculation methods!

New Products NEW

Accessories for mounting bracket for metal roofs 105 241

105



- C-shaped mounting rails with holes and hanger bolts for wood and metal for fixing mounting bracket Part No. 105 241 to, e.g. corrugated sheet roofs.

HVI light Conductor (500 m on reel)

144



- 500 m HVI light Conductor supplied on a disposable plywood reel. Total weight of approx. 290 kg. Empty weight approx. 35 kg, drum width approx. 670 mm, flange diameter 1000 mm.

Hammer inserts for tubular earth rods

252



- Hammer inserts for tubular earth rods $\varnothing 25$ mm and $\varnothing 27$ mm with fitting hexagonal wrench size 28 mm and TE-S (hexagonal wrench size 22 mm).



Preface	3
Quick Product Selection	Fold-out page
Wind Load in Case of Isolated Air-Termination Systems	Fold-out page
New Products	Inner cover
Our Promise – DEHN protects.	3
DEHN – International	4
DEHN – Informs	5
Requirements for External Lightning Protection Components	7

Services	11
DEHNconcept – Planning of lightning protection systems	12
DEHN Customised Engineering – Customised Lightning Protection / Earthing Products	14
DEHNsupport Toolbox	15

Air-Termination System / Down Conductor / Isolated Lightning Protection	16
1 Conductor Material	19
2 Flat Roof	25
3 Gable Roof	31
4 Metal Roof / Corrugated Sheet Roof	41
5 Down Conductor	45
6 Earth Entry	57
7 Clamps / Connectors	73
8 Air-termination Rods / Tips	95
9 Isolated Lightning Protection	115
10 Reinforcement Technology	129

HVI Lightning Protection	139
HVI light Conductor	142
DEHNcon-H	155
HVI Conductor	166
HVI power Conductor	194

Protection against Step and Touch Voltage	216
--	------------

Earthing / Equipotential Bonding	223
1 Conductor Material	225
2 Fixed Earthing Terminals / Wall Bushings	233
3 Clamps / Connectors	239
4 Earth Rods	245
5 Telecommunications	255
6 Equipotential Bonding	265
7 Equipotential Bonding for Ex Areas	279
8 Accessories	289

Index	295
Part No / Type Index	295
German Armed Forces – Stock Nos.	317
Key Words	318
Notes	319
DEHN – Informs / Conversion Table	320
Abbreviations	Inner cover



General Terms And Conditions

Our General Terms and Conditions in the current version (under www.dehn-international.com) apply for deliveries and services.

By the way of derogation our General Terms and Conditions DEHNconcept (page 12/13) and DEHN Test Centre apply in the latest version (under www.dehn-international.com).

Main Catalogue Lightning Protection/Earthing valid as of January 1, 2020

This catalogue replaces the Main Lightning Protection / Earthing Catalogue 2019.

We reserve the right to introduce changes in configuration and technology, dimensions, weights and materials within the scope of technical progress. Illustrations are not binding. We accept no liability for misprints, modifications and errors. Any reproduction of this catalogue, as a whole or in parts, is only allowed upon approval of DEHN.



Our promise



"We are a reliable partner for our customers and employees."

Dr Philipp Dehn
Chief Executive Officer

DEHN protects.

Dear business associates,

Our family-run business stands for safety and pioneering spirit in all matters of lightning and surge protection and safety equipment. Increasingly complex technical innovations and networks require enhanced protection.

We offer you the added value of readily available protective components, equipment, solutions and services of consistently high quality. You can rely on us, your worldwide partner for lightning and surge protection and safety equipment, to provide the best possible service.

We think ahead and ensure that the solutions we find with you today are also fit to meet the requirements of tomorrow. We invest in the future to give you a real competitive edge, e.g. our high-voltage-resistant insulated down conductor, the HVI Conductor which is tailored to your applications, our ACI (Advanced Circuit Interruption), an innovative surge protection technology, or our sophisticated safety equipment. We are currently active in the field of occupational safety with high-pressure water jets and have already designed a completely new protective overall.

With heart and mind, passion and pioneering spirit, we drive forward developments in surge and lightning protection and safety equipment.

Digital transformation touches all aspects of our lives. We want to be your partner when it comes to protecting trend-setting smart energy and data solutions because all intelligent components have one thing in common: the sensitive "smart" electronics need protecting against the effects of lightning and surges. This applies to all electrically conductive systems, i.e. both power technology and information and communications technology. Let us combine our products, services and expertise with your protection requirements to create a tangible benefit for you and for us. We want to create a safer environment for you with new protection solutions to fit the continuously developing technology.

Take advantage of what we have on offer in terms of lightning and surge protection and safety equipment and help us to make the world just that little bit safer. I look forward to your interest and the chance to work with you!

Your

Dr Philipp Dehn



"Our customers are the focal point of our activities."

Helmut Pusch
Chief Sales Officer

Shared success

Our goal is to combine our products, solutions and expertise in such a way that the benefits are tangible, both for you and us. DEHN provides intelligent and sustainable protective solutions to meet your current and future requirements. We are your fair and reliable global partner. On- and offline we help you by providing information and comprehensive support. Strong sales teams, a network of 20 foreign subsidiaries and representative offices, and more than 70 sales partners worldwide are at your side for the purpose. We are particularly committed to imparting knowledge. We pass on our practical expertise on products and solutions through the hundreds of seminars, workshops, training sessions and conferences held annually and, not least, through our book the 'Lightning Protection Guide'. You, the customer, profit from our solutions and keep your finger on the pulse of time in terms of future protection solutions and requirements. Let us work together to make the increasingly complex and digital world just that little bit safer.

Your

Helmut Pusch

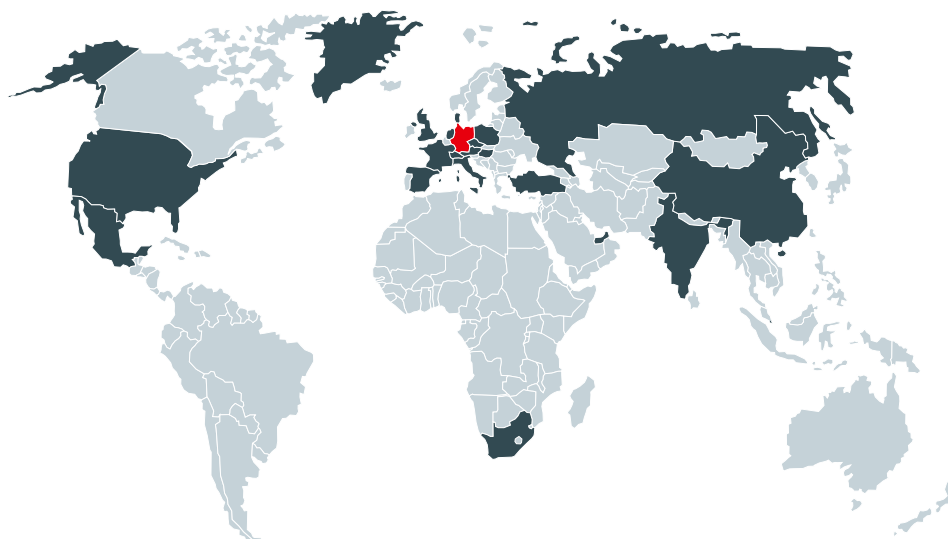

DEHN SE + Co KG

Customer Service Center

Commercial customer service
sales@dehn.de
Phone +49 9181 906-1547
Fax +49 9181 906-1444

Technical Support
itss@dehn.de
Phone +49 9181 906-1774
Fax +49 9181 906-1444

Subsidiaries and Representative Offices

Austria:	DEHN AUSTRIA GmbH	www.dehn.at
China:	DEHN Surge Protection (Shanghai) Co. Ltd.	www.dehn.cn
Czech Republic:	DEHN s.r.o.	www.dehn.cz
Denmark:	DESITEK A/S	www.desitek.dk
France:	DEHN FRANCE S.à.r.l.	www.dehn.fr
Great Britain:	DEHN (U.K.) LTD.	www.dehn.co.uk
Hungary:	DEHN office Budapest	www.dehn.hu
India:	DEHN INDIA Pvt. Ltd.	www.dehn.in
Italy:	DEHN ITALIA S.p.A.	www.dehn.it
Mexico:	DEHN PROTECTION MÉXICO, S.A. de C.V.	www.dehn.mx
Netherlands:	DEHN NEDERLAND B.V.	www.dehn.nl
Poland:	DEHN POLSKA Sp. z o.o.	www.dehn.pl
Russia:	OOO DEHN RUS	www.dehn-ru.com
Singapore:	DEHN (SEA) PTE. LTD.	www.dehn.sg
South Africa:	DEHN AFRICA (Pty) Ltd.	www.dehn-africa.com
Spain:	DEHN IBÉRICA Protecciones Eléctricas, S.A. Unipersonal	www.dehn.es
Switzerland:	ELVATEC AG	www.elvatec.ch
Turkey:	DEHN office Istanbul	www.dehn.com.tr
United Arab Emirates:	DEHN MIDDLE EAST FZE	www.dehn.ae
USA:	DEHN Inc.	www.dehn-usa.com

Sales activities in more than 70 countries worldwide

You can find your current local contact person online at:
<http://www.dehn-international.com/en/contact>

Benjamin Franklin, inventor of the lightning rod, recognised lightning as an electrical phenomenon back in 1752. It is common knowledge today that lightning protection is more than just a “cage” made up of an air-termination system, down conductors and an earth-termination system. It is a comprehensive protection system explained and specified in standards. The current standard series IEC/EN 62305 is an internationally coordinated standard and provides a comprehensive overall concept for lightning protection. It is legally and technically binding.

DEHN offers components and devices for complete lightning protection systems. Components for the installation of the external lightning protection system have to meet the mechanical and electrical requirements as specified in the standard series EN 62561-x. Our products are, of course, manufactured and tested in accordance with the relevant standards.

To always be one step ahead and better than the state-of-the-art is a matter of particular importance to us in the interest of our customers, today and in the future.

In our highly specialised laboratories lightning parameters are simulated in order to test installations/systems for lightning safety and upgrade them if necessary.

Special solutions for lightning and surge protective systems can be tested and analysed in accordance with the current international and national standards. In addition, we have been working actively on international and national standardisation committees for decades. You can rest assured that our devices and extensive knowledge are based on the current state of standardisation. Implementation of a functional lightning protection system requires the application of components and devices that are tested and conform to the latest standards. The installers of lightning protection systems have to choose the components in accordance with the installation requirements of individual sites and to install them correctly. Apart from the mechanical requirements, the electrical criteria also have to be considered and complied with.

DEHN provides tests and analyses of lightning and surge protection systems for your safety.

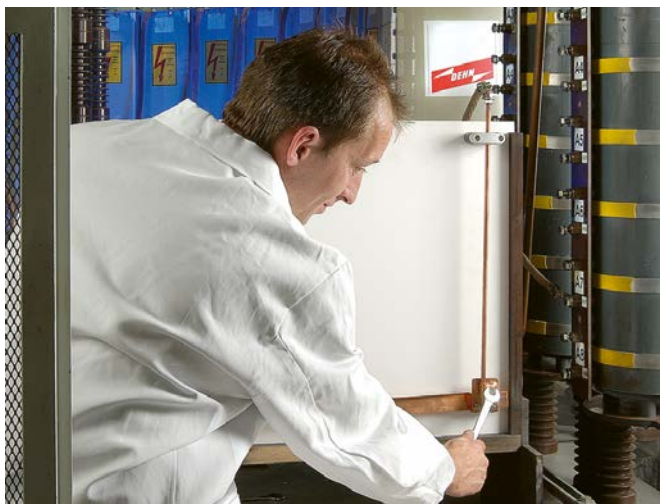

Test reports, test certificates and data sheets

DEHN provides you with detailed installation instructions, data sheets and test reports in order to support you with the design of installations and systems. The necessary technical details are practice-orientated and documentation is continuously updated and always available at www.dehn-international.com. After the system installation, we also assist you with technical documentation, e.g. concerning a system inspection and the corresponding test certificates (e.g. a lightning protection system tested in accordance with IEC/EN 62305-3 or documentation of the earth-termination system).

These are also available at www.dehn-international.com.

Numerous brochures with practical information on our products as well as many white papers complete the range of services available and can also be downloaded at www.dehn-international.com/en/downloads.

Planning software for lightning protection systems

The DEHNsupport Toolbox software program provides easy to use and practical programs for planners and installers, ranging from a complete risk assessment to the calculation of the air-termination rod length, the determination of the separation distance and the calculation of the length of the earth electrodes. This makes designing a lightning protection system considerably easier. See page 15 for more details.



LIGHTNING PROTECTION GUIDE

The DEHN LIGHTNING PROTECTION GUIDE has been an indispensable aid for technical experts and is the benchmark for practice-orientated technical literature in the field of lightning and surge protection of buildings and structures. Whatever you need for the practical understanding of lightning and surge protection – the LIGHTNING PROTECTION GUIDE provides comprehensive and detailed expert knowledge about, e.g. standards, regulations, project planning basics, installation examples and white papers for special applications on more than 400 pages. The DEHN LIGHTNING PROTECTION GUIDE is available as printed book, as a pdf file, on CD or at www.dehn-international.com/en/lightning-protection-guide.



DEHNacademy

DEHN offers a wide spectrum of practice-orientated training sessions and events in the fields of surge protection, lightning protection / earthing and safety equipment. In seminars, you will learn how to use our components and devices in practice. You can also use our e-Learning service at www.dehn-international.com/en/dehnacademy-e-learning.

Videos

A picture is worth a thousand words. On our YouTube channel DEHN Deutschland (www.youtube.com/c/DEHNde) you will find helpful application and installation videos, learn more about our products and get to know us better on a tour through the company. Follow us!

DEHN accredited by DAkkS

At the end of 2017, the DEHN Test Centre was awarded an accreditation certificate (Registration number D-PL-20356-01-00) by the Deutsche Akkreditierungsstelle, DAkkS (German accreditation body). For DEHN this is further objective proof of the quality and competency of its testing. More information can be found at: www.dehn-international.com/pr/dakks

DEHN – quick and direct

Proximity to our customers is important to us! We are at your disposal for any questions on special application topics concerning DEHN products under the service hotline +49 9181 906-1750. You can also contact our competent partners in your region. We shall be pleased to provide you with the name of the contact person at our subsidiaries or representatives. More details and information at www.dehn-international.com.

The lightning protection / earthing catalogue comprises components for lightning protection, earthing and equipotential bonding. More technical information is available at www.dehn-international.com. We also shall be pleased to send you brochures.

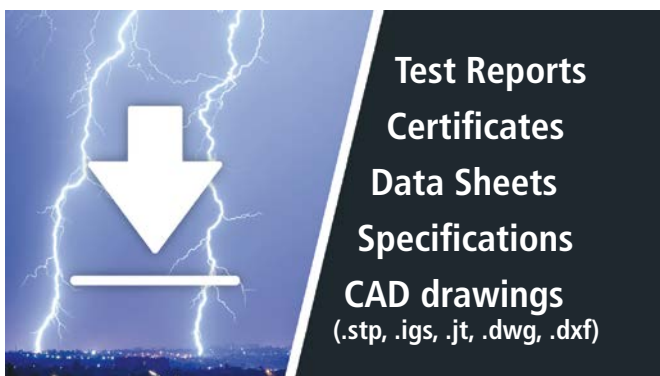

Product documentation / construction and CAD drawings

Planning, design and implementation drawings of lightning and surge protection systems require detailed product documentation. Computer Aided Engineering (CAE) is based on construction and CAD drawings.

DEHN provides you with the following documents and drawings for collective download:

- Installation instructions / instructions for use
- Test reports
- Certificates
- Data sheets
- Specifications
- CAD drawings (file formats: .stp, .igs, .jt, .dwg, .dxf)

Supported product ranges:

- **Surge Protection** Red/Line and Yellow/Line (complete)
- **Lightning Protection / Earthing** (partly; rest in preparation)
- **Safety Equipment** (partly; rest in preparation)

Proceed as follows:

1. Registration at <https://www.dehn-international.com/user/register> or
2. Login at <https://www.dehn-international.com/user>
3. Place the selected products in the shopping cart
4. Collective download of all components in the shopping cart

Collective download of certificates and test reports

Collective download of certificates and test reports from the notepad of our website is now possible. The procedure is the same as for the collective downloads of data sheets, etc.

Please note: Certificates and/or test reports are not available for all products.

More information at

www.dehn-international.com/en/lightning-protection

Data sheets, test reports, 3D data and much more can be found on the internet:

<http://de.hn/enpd>

Information and documentation

Brochures

- | | | | |
|----------|--|----------|--|
| DS139E | Protection Against Touch Voltage – High-voltage-resistant, insulated CUI Conductor | DS255E | HVI and HVI power Conductor for Ex zones 1 and 21 (pdf only) |
| DS151E | Reliable System Solutions for Isolated Air-Termination Systems | DS263E | Fast and safe DEHNclip – The new rebar clip |
| DS162E | Foundation Earth Electrode | DS264E | Maxi MV clamp with tear-off screw (pdf only) |
| DS177E | DEHNiso Roof Conductor Holder | DS266E | Registration of lightning strikes – Lightning strike counter for discharge occurrences up to 100 kA (pdf only) |
| DS202D/E | DEHN UNI Earthing Clamp / Saddle Clamp (pdf only) | DS267E | Assortment case for marking lightning protection and earth-termination systems |
| DS210E | HVI power (pdf only) | DS279D/E | Equipotential bonding in hazardous areas |
| DS212E | Innovation in lightning protection – High voltage-resistant, insulated HVI Conductor | DS306/E | Safely earthing and protecting antenna / SAT systems |
| DS236E | Lightning protection for ETIC systems – Test junction box for external thermal insulation composite systems (pdf only) | DS407/E | Customised products for lightning protection and earthing products |
| DS242E | Copperbonded earth rods and accessories (pdf only) | | |
| DS244E | 200 kA-clamps – For classes of LPS I and II (pdf only) | | |
| DS254E | Safe and robust – Six-legged support for 10 m and 11 m air-termination rods (pdf only) | | |

Reprints

- SD75E Lightning protection systems with ESE devices ... under scrutiny – Aus Elektropraktiker, Ausgabe 10/2010

Components used for installing the external lightning protection system shall meet the mechanical and electrical requirements, as specified in the EN 62561-x standard series. Lightning protection components are categorised according to their function, for example connection components (EN 62561-1), conductors and earth electrodes (EN 62561-2).

Testing of conventional lightning protection components

Metal lightning protection components (clamps, conductors, air-termination rods, earth electrodes) exposed to the elements have to be subjected to artificial ageing/conditioning prior to testing to verify their suitability for the intended application. In accordance with EN 60068-2-52 and EN ISO 6988 metal components are subjected to artificial ageing and tested in two steps.

Natural weathering of lightning protection components and exposure to corrosion

Step 1: Salt mist treatment

This test applies to components or devices for installation in saline atmospheres. The specimens are tested with severity level 2 in a salt mist chamber (Figure 1) for three days. Test level 2 consists of three spraying phases of 2 h each, using a 5% sodium chloride solution (NaCl) at temperatures between 15 °C and 35 °C followed by storage at a relative humidity of $93 \pm 3\%$ and a temperature of 40 ± 2 °C for 20 to 22 hours in accordance with EN 60068-2-52.

Step 2: Humid sulphurous atmosphere treatment

This test is to evaluate the resistance of materials or objects to condensed humidity containing sulphur dioxide in accordance with EN ISO 6988.

The test is carried out in a test chamber (Figure 2) in seven test cycles of 24 h each in a sulphur dioxide concentration of 667×10^{-6} ($\pm 24 \times 10^{-6}$) of the volume. Each cycle has a heating period of 8 h at a temperature of 40 ± 3 °C in a humid, saturated atmosphere followed by a rest period of 16 h. After that, the humid sulphurous atmosphere is replaced. Both components for outdoor use and components buried in the ground are subjected to ageing / conditioning. For components buried in the ground additional requirements and measures have to be considered. No aluminium clamps or conductors may be buried in the ground. If stainless steel is to be buried in the ground, only high-alloy stainless steel may be used, e.g. StSt (V4A). In accordance with the German DIN VDE 0151 standard, StSt (V2A) is not allowed. Components for indoor use such as equipotential bonding bars do not have to be subjected to ageing / conditioning. The same applies to components which are embedded in concrete. These components are therefore often made of non-galvanised (black) steel.

Air-termination systems / air-termination rods

Air-termination rods are typically used as air-termination systems. They are available in many different designs, ranging from 1 m for installation with concrete base on flat roofs, to telescopic lightning protection masts with a length of 25 m for biogas plants.

EN 62561-2 specifies the minimum cross sections and the permissible materials with the corresponding electrical and mechanical properties for air-termination rods.

In case of air-termination rods with larger heights, the bending resistance of the air-termination rod and the stability of complete systems (air-termination rod in a tripod) have to be verified by means of a static calculation. Selection of the required cross sections and materials is based on this calculation. The wind speeds of the relevant wind load zone also have to be taken into account for this calculation.

Testing of connection components

Connection components, often simply called clamps, are used as lightning protection components to connect conductors (down conductor, air-termination conductor, earth entry) to each other or to an installation. Depending on the type of clamp and clamp material, a lot of different clamp combinations are possible. The conductor routing and the possible



Figure 1:
Test in a salt mist chamber.



Figure 2:
Test in a Kesternich chamber.

material combinations are decisive in this respect. The kind of conductor routing describes how a clamp connects the conductors in cross or parallel arrangement.

In case of a lightning current load, clamps are subjected to electrodynamic and thermal forces which highly depend on the kind of conductor routing and the clamp connection. Table 1 shows materials which may be combined without causing contact corrosion.

The combination of different materials with one another and their different mechanical strengths and thermal properties have different effects on the connection components when lightning current flows through them. This is particularly evident for stainless steel (StSt) connection components where high temperatures occur due to the low conductivity as soon as lightning currents flow through them. Therefore, a lightning current test in compliance with EN 62561-1 has to be carried out for all clamps. In order to test the worst case, not only the different conductor combinations but also the material combinations specified by the manufacturer have to be tested.

Tests based on the example of an MV clamp

At first, the number of test combinations has to be determined. The MV clamp used is made of stainless steel (StSt) and hence can be combined with steel, aluminium, StSt and copper conductors as stated in **Table 1**. Moreover, it can be connected in cross and parallel arrangement which also has to be tested. This means that there are eight possible test combinations for the MV clamp used (**Figures 3 and 4**).

In accordance with EN 62561 each of these test combinations has to be tested on three suitable specimens / test set-ups. This means that 24 specimens of this single MV clamp have to be tested to cover the complete range. Every single specimen is mounted with the adequate tightening torque in compliance with normative requirements and is subjected to artificial ageing by means of salt mist and humid sulphurous atmosphere treatment as described above. For the subsequent

	Steel	Aluminium	Copper	StSt	Titanium	Tin
Steel (St/tZn)	yes	yes	no	yes	yes	yes
Aluminium	yes	yes	no	yes	yes	yes
Copper	no	no	yes	yes	no	yes
StSt	yes	yes	yes	yes	yes	yes
Titanium	yes	yes	no	yes	yes	yes
Tin	yes	yes	yes	yes	yes	yes

Table 1: Possible material combinations for air-termination systems and down conductors and for connection with structural parts.



Figure 3: New and aged components.



Figure 4: Test combinations for MV clamps (parallel and cross arrangement).

electrical test the specimens have to be fixed on an insulating plate (**Figure 5**).

Three lightning current impulses of 10/350 μ s wave form with 50 kA (normal duty) and 100 kA (heavy duty) are applied to every specimen. After being loaded with lightning current, the specimens must not show signs of damage.

In addition to the electrical tests where the specimen is subjected to electrodynamic forces in case of a lightning current load, a static-mechanical load was integrated in the EN 62561-1 standard. This static-mechanical test is particularly required for parallel connectors, longitudinal connectors, etc. and is carried out with different conductor materials and clamping ranges. The connection components are prepared with a defined tightening torque and then loaded with a mechanical tensile force of 900 N (± 20 N) for one minute. During this test period, the conductors must not move more than one millimetre and the connection components

must not show signs of damage. This additional static-mechanical test is another test criterion for connection components and also has to be documented in the manufacturer's test report in addition to the electrical values.

The contact resistance (measured above the clamp) for a stainless steel clamp must not exceed 3 m Ω or 1 m Ω in case of other materials. The required loosening torque has to be ensured. A manufacturer's test report is prepared for every test combination. A detailed test report is available from the manufacturer upon request or a less detailed report can be downloaded from the internet (www.dehn-international.com => Product data).



Consequently, installers of lightning protection systems have to select the connection components for the duty (H or N) to be expected on site. A clamp for duty H (100 kA), for example, has to be used for an air-termination rod (full lightning current) and a clamp for duty N (50 kA) has to be used in a mesh or at an earth entry (lightning current already distributed).

Conductors

EN 62561-2 also places special demands on conductors such as air-termination and down conductors or earth electrodes e.g. ring earth electrodes, for example:

- Mechanical properties (minimum tensile strength, minimum elongation),
- Electrical properties (max. resistivity) and
- Corrosion resistance properties (artificial ageing as described above).

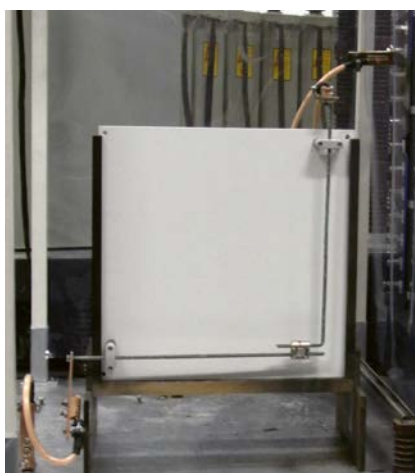

Figure 5: Specimen fixed on insulating plate (MV clamp) for a test in the impulse current laboratory.

The mechanical properties have to be tested and observed. The quality of coating (smooth, continuous) as well as the minimum thickness and adhesion to the base material are important and have to be tested particularly if coated materials such as galvanised steel (St/tZn) are used.

This is described in the standard in the form of a bending test. For this purpose, a specimen is bent through a radius equal to 5 times its diameter to an angle of 90°. In doing so, the specimen may not show sharp edges, breakage or exfoliation. Moreover, the conductor materials shall be easy to process when installing lightning protection systems. Wires or strips (coils) are supposed to be easily straightened by means of a wire straightener (guide pulleys) or torsion. Furthermore, it should be easy to install / bend the materials at structures or in the soil. These standard requirements are relevant product features which have to be documented in the corresponding product data sheets of the manufacturers.

Earth electrodes / earth rods

The separable DEHN earth rods are made of special steel and are completely hot-dip galvanised or consist of high-alloy stainless steel (StSt (V4A); material No. 1.4571). A coupling joint which allows connection of the rods without enlarging the diameter is a special feature of these earth rods. Every rod provides a bore and a pin end.

EN 62561-2 specifies the requirements for earth electrodes such as material, geometry, minimum dimensions as well as mechanical and electrical properties. The coupling joints linking the individual rods are weak points. For this reason, EN 62561-2 requires that additional mechanical and electrical tests be performed to test the quality of these coupling joints.

For this test, the rod is put into a guide with a steel plate as impact area. The specimen consists of two joined rods with a length of 500 mm each. The top end of the specimen is impacted by means of a vibration hammer with an adequate hammer insert for a duration of two minutes. The blow rate of the hammer must be $2000 \pm 1000 \text{ min}^{-1}$ and the single stroke impact energy must be $50 \pm 10 \text{ [Nm]}$.

If the couplings have passed this test without visible defects, they are subjected to artificial ageing by means of salt mist and humid sulphurous atmosphere treatment. Then the couplings are loaded with three lightning current impulses of 10/350 μs wave form of 50 kA and 100 kA each. The contact resistance (measured above the coupling) of steel earth rods must not exceed 1 m Ω (stainless steel 3 m Ω). To test whether the coupling joint is still firmly connected after being subjected to this lightning current load, the coupling force is tested by means of a tensile testing machine.

Testing of insulated conductors and spacers

In accordance with the new component standard IEC TS 62561-8 Edition 1.0 2018-01, in future also insulated conductors including system components as well as insulated spacers (GRP) must be tested mechanically as well as electrically. The tests differ according to the type of product.

Insulated conductors – HVI Conductors

A high-voltage-resistant insulated conductor (HVI Conductor) as well as the corresponding mounting material must, in compliance with IEC TS 62561-8 Edition 1.0 2018-01, be able to insulate and safely discharge lightning currents. Mechanical loads and environmental influences are also considered. Therefore both, UV light tests and corrosion tests are also required in the component standard.

Test scope for insulated conductors

- High voltage test for proving the electric strength of the insulated conductor (proof of dielectric strength); and as a system test (see Figure 6)
- Test for lightning current carrying capability of the insulated conductor according to the specifications of IEC 62561-1 with a test impulse in accordance with the manufacturer's classification of IEC TS 62561-8 Edition 1.0 2018-01

Test scope for conductor holders

- Axial tensile force (mounted conductor, holder distance 250 mm, axial tensile load 50 N)
- Bending test (mounted conductor, holder distance 250 mm, vertical tensile load 200 N, time depends on type of holder)



Figure 6: High voltage test according to IEC TS 62561-8 Edition 1.0 2018-01 of a HVI system with four HVI Conductors.

Insulated spacers – DEHNiso spacers

When testing insulated spacers, one differentiates between the way they are mounted: self-supporting components (spacer in a concrete base) and horizontally mounted holders (air-termination rod with spacer). Before mechanical and electrical testing, the specimens must pass a UV light and a corrosion test.

Scope of mechanical test

- Bending test (length to specimen 500 mm, min. load 10 N, min. 60 min)
- Impact test centred (length of specimen 500 mm, force 2 J)
- Tensile force (length of specimen 500 mm, tensile force 200 N)

Scope of electrical test

For the electrical testing, high voltage is applied on the set-up. Insulated spacers must have a dielectric strength in accordance with standard requirements of IEC TS 62561-8 Edition 1.0 2018-01.

Test according to IEC TS 62561-8 Edition 1.0 2018-01 at DEHN

DEHN products for isolated lightning protection are designed for the requirements according to IEC TS 62561-8 Edition 1.0 2018-01.

General note!

Using components and devices which have been tested in compliance with the latest standards is a basic prerequisite for a functional lightning protection system. Installers of lightning protection systems must select components according to the requirements at the installation site and install them in accordance with the manufacturers' specifications. In state-of-the-art lightning protection technology, it is important to consider and comply with electrical criteria in addition to mechanical requirements.



DEHN protects.

Services

DEHN offers comprehensive services in the field of
Lightning Protection / Earthing

DEHNconcept – Planning of
lightning protection systems



DEHN Customised Engineering –
Customised lightning protection /
earthing products



DEHNsupport Toolbox



Our engineering know-how for your projects

In addition to our protection devices and solutions which are used world-wide, DEHN offers planning services. Our expertise is based on more than ten years of experience in planning lightning and surge protection solutions for different projects and industries. Our services include planning for industrial plants, e.g. for petro-chemical and power plants as well as for office and production buildings. The planning services we offer are important for the successful realisation of a project. As the requirements are industry and country specific we closely cooperate with our customers. Successful planning has to be well-prepared. Project discussions and on-site surveys ensure high quality planning. To order, we draw up a lightning protection and earthing concept including drawings, mounting details, descriptions, tender specifications and bills of material for the customer which he can then use for his own documentation. If desired, we can also provide a material quotation.

Our services include:

- As-built data collection, project discussions, site surveys
- Risk analysis*
- Laserscanning**
- Assessment of material costs
- Planning of the lightning protection/earthing concept
- Lightning protection concept including detail engineering, detailed descriptions and 3D/2D drawing
- Calculation of the separation distance
- Detailed mounting drawing of the air-termination system
- Calculation of the earthing system for the transformer
- Tender specifications for tender invitations
- Bill of material and material quotation (optional)
- Surge protection concepts

3D planning of lightning protection concepts

When planning complex objects and structures it is helpful to use a 3D program to achieve an efficient configuration of the air-termination devices which considers all parts of the structure. Air-termination devices can be used much more effectively than with the 2D process. Due to the increasing requirements regarding the building architecture, 3D planning is a very good solution for visually representing lightning protection measures. Based on our 3D planning, customers get an idea of how to integrate the lightning protection measures into the building architecture. Another advantage is the clear visualisation of the protected volume of the air-termination systems.

Laser scanning for 3D lightning protection planning

3D laser scanning enables fast and accurate measurement of complex existing objects and buildings. With the help of a laser scanner, an existing plant or building can be recorded in great detail and digitalised. More information at www.dehn-international.com/dehnconcept

For more detailed information and enquiries, please contact our DEHNconcept team:

Contact:

DEHNconcept Team
Tel.: + 49 9181 906-1600
Fax: + 49 9181 906-1046

dehnconcept@dehn.de
www.dehn-international.com/dehnconcept

* IEC 62305-2: Protection against lightning – Part 2: Risk management

** Based on lightning protection planning

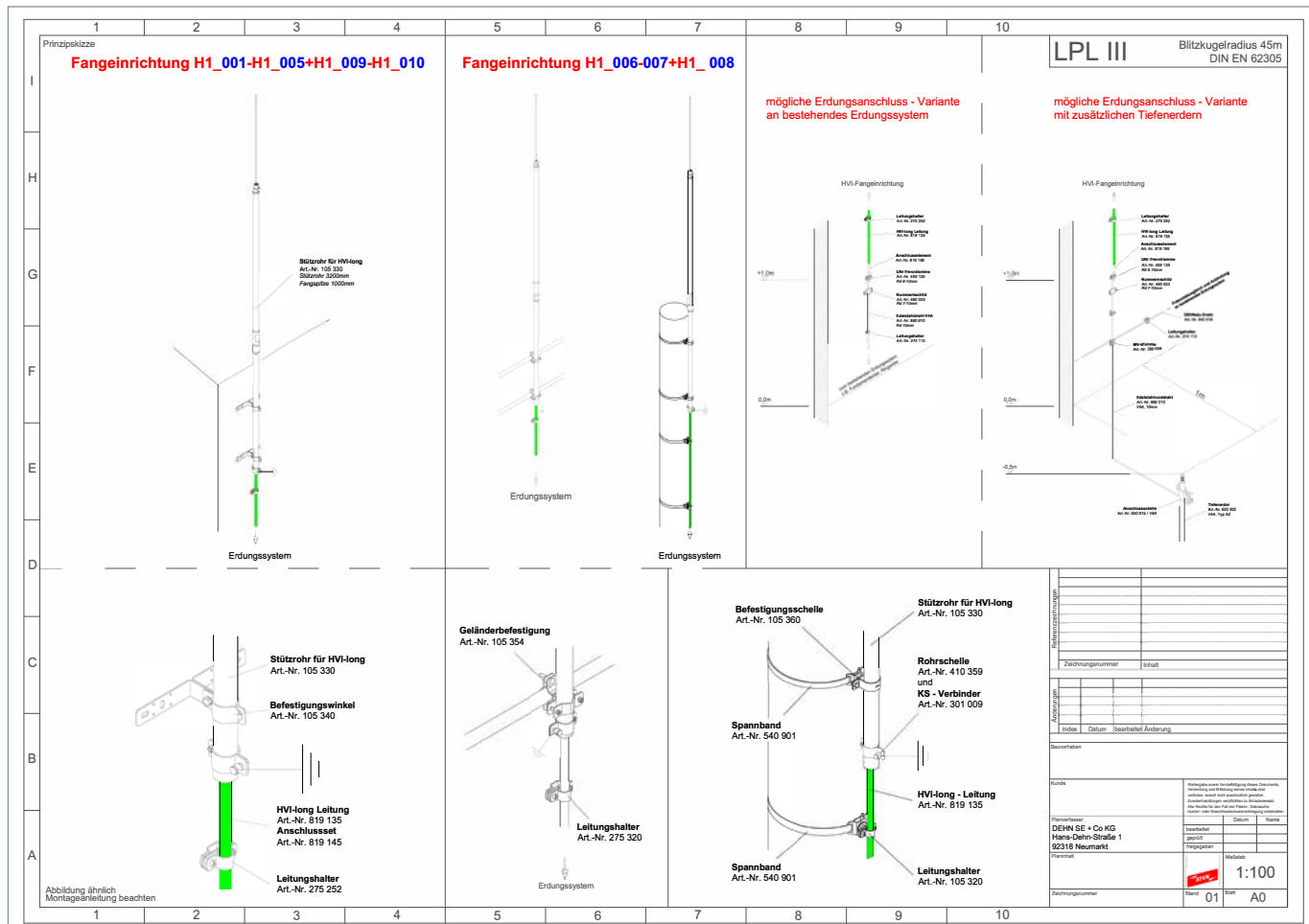

Detailed view of the earth-termination system



Air-termination rods with special lengths



Support for air-termination rods 22/16/10 for fixing on the ground



Spacer with tensioning strap fastener



Earthing busbar with special hole pattern and dimensions

We also manufacture customised products – easily, quickly and at low costs

Continuously changing materials and designs in the building sector require individual solutions – e.g. for holder systems or clamping devices for lightning protection and earth-termination systems. In addition to our broad lightning protection / earthing portfolio, we also offer numerous customised products in proven DEHN quality.

Examples

- Air-termination rods with special lengths or for higher wind loads including calculation
- Components for increased corrosion requirements
- Clamps and holders for non-standard cross-sections or with different screws
- Equipotential bonding bars with a non-standard cross-section or different hole pattern
- Special conductor material also in special winding
- Accessories of all kinds (e.g. hammer inserts for earth rods)

Customised product enquiries

To be able to efficiently process your enquiries for customised products, the following information is required:

- Detailed description of the desired product or product modification with reference to our standard product
- Description of special framework parameters (e.g. wind load, corrosion requirements, mounting possibilities)
- Quantity and desired delivery date
- Contact data

Please use the form Lightning Protection / Earthing Products for your enquiry:

It is available on our homepage at www.dehn-international.com/en/customised-lightning-protectionearthing-products

Within three working days, you will receive the following information:

- Feasibility of the customised product or an alternative suggestion
- Prices and scheduled delivery date

Contact:

For enquiries, please contact your customer support or:

DEHN Customised Engineering
Tel.: + 49 9181 906-2025

c.engineering@dehn.de
www.dehn-international.com



- System requirements:**
- Supported operating systems: Windows® Vista / 7 / 8 / 8.1 / 10
 - Office package with word processing and spreadsheet
 - Internet connection (optional)

DEHNsupport Software Basic Version¹

Part No.	199999
----------	--------

DEHNsupport Software Distance Edition¹

Part No.	199950
----------	--------

Upgrade Module DEHN Distance Tool¹

Part No.	199970
----------	--------

Multi-User Installation DEHNsupport^{1,2}

Part No.	99411
----------	-------

1) Software for 2 workstations (single-user installation)

2) Multi-user installation is also available for 2 or more workstations

Program contents

Calculation Program for Lightning Protection Systems

The DEHNsupport Toolbox is a calculation tool for the specific determination and implementation of lightning and surge protection measures based on the requirements of the IEC/EN 62305-1 to 4 standard series. In addition to international requirements, country-specific adaptations are integrated in the software which are regularly extended. In order to specifically support users with their application, the DEHNsupport Toolbox offers a variety of planning aids:

DEHN Risk Tool; risk management in accordance with IEC/EN 62305-2

Risk analysis: An analysis of the hazard potential for structures allows an economically viable selection of protection measures which are suitable for the characteristics and the utilisation of the building.

DEHN Air-Termination Tool; calculation of the air-termination rod length in accordance with IEC/EN 62305-3

This software tool allows calculation of the length of air-termination rods depending on the class of LPS.

DEHN Distance Tool; calculation of the separation distance in accordance with IEC/EN 62305-3

A 3D model of the building with automatic calculation of the separation distance s forms the basis of the DEHN Distance Tool module. This automatic calculation is based on nodal analysis, saves time and simplifies work processes.

DEHN Earthing Tool; calculation of the earth electrode length in accordance with IEC/EN 62305-3

With this tool you can determine the required length of earth electrodes, taking the type of earth electrode, the class of LPS and soil resistivity into account.

DEHNselect SPD Tool; selection of surge protective devices

The new DEHNselect SPD Tool facilitates planning and allows the professional implementation of an efficient internal lightning and surge protection concept.

Order Information

The product includes two single-user licences. The DEHNsupport Toolbox software is available in different combinations:

Basic Version (single-user installation)

DEHNsupport Distance Edition software including risk analysis, calculation of earth electrode and air-termination rod lengths, calculation of the separation distance based on nodal analysis as well as selection of the protective devices.

Distance Edition (single-user installation)

DEHNsupport Distance Edition software including risk analysis, calculation of earth electrode and air-termination rod lengths, as well as selection of the protective devices.

Upgrade from Basic to Distance Edition

An upgrade for calculating the separation distance according to the nodal analysis method can be purchased if a Basic Version is already installed.

Multi-user installation of the DEHNsupport software

Multi-user installation for more than two workstations is also available. The price depends on the number of users.

Detailed information, an order form and a demo version are available at www.dehn-international.com. The demo version already includes the new DEHNselect SPD Tool module (free full version).

External lightning protection of a residential building

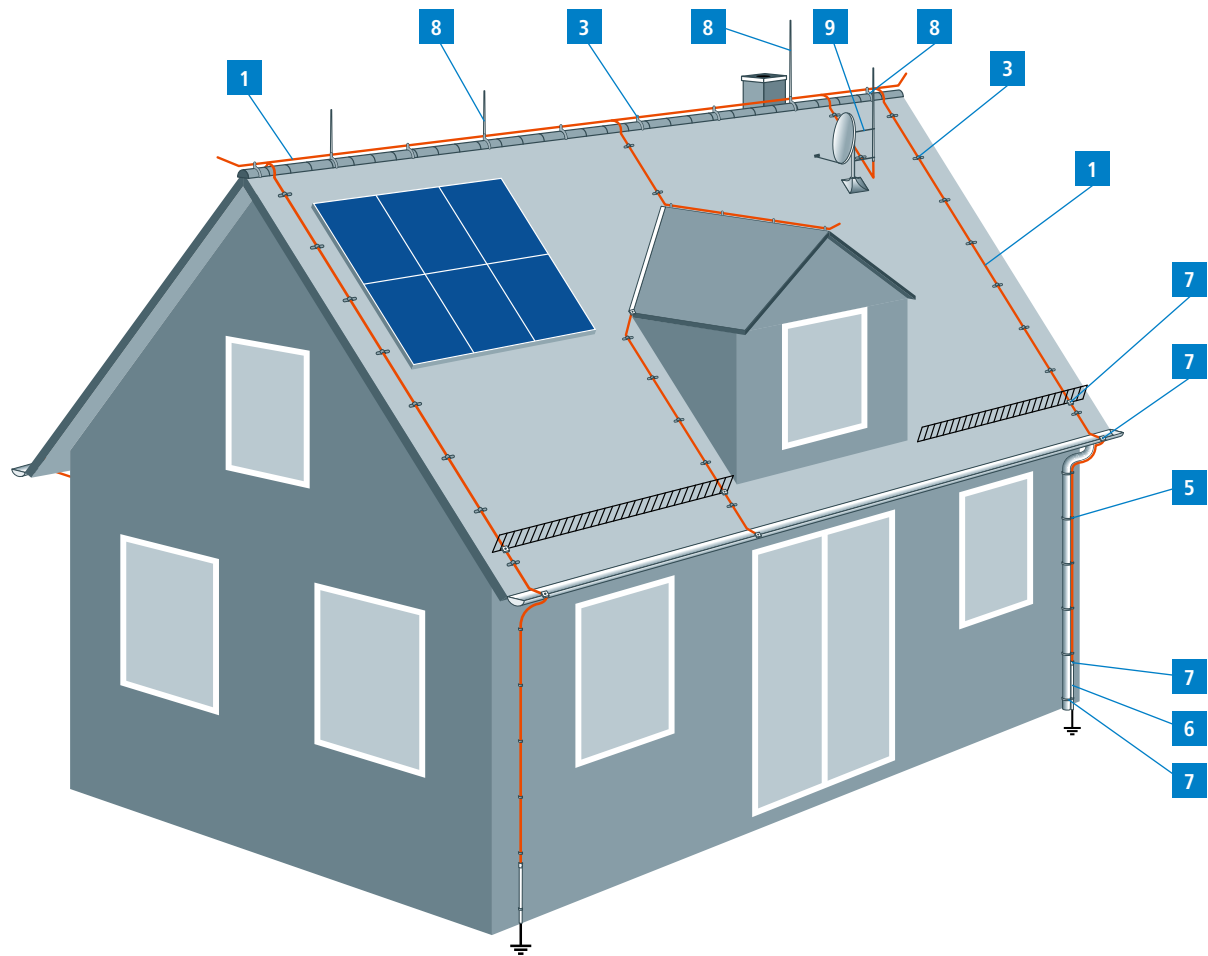

External lightning protection of an industrial building

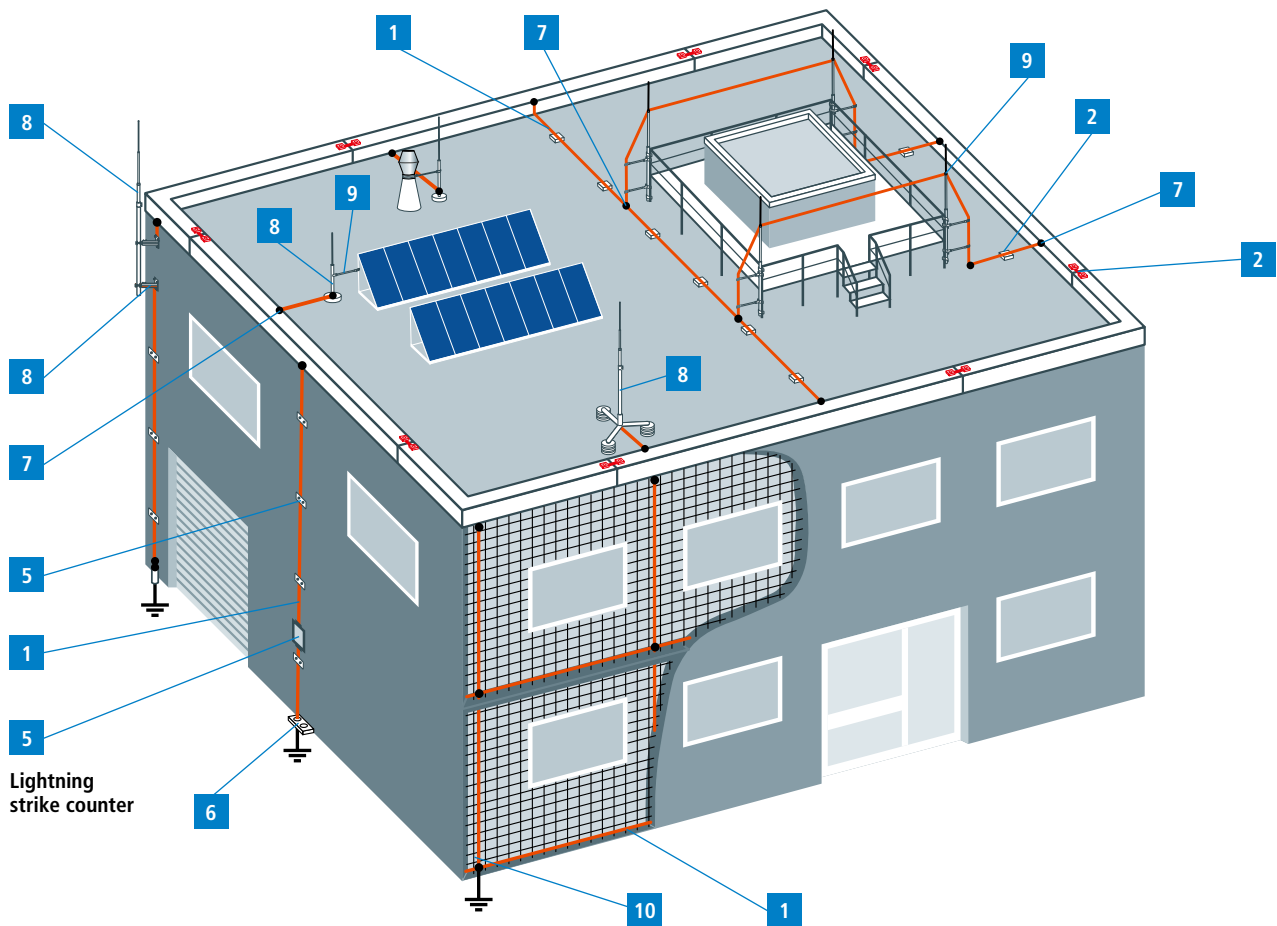

Protection of an antenna system in case of an existing lightning protection system in accordance with IEC 60728-11

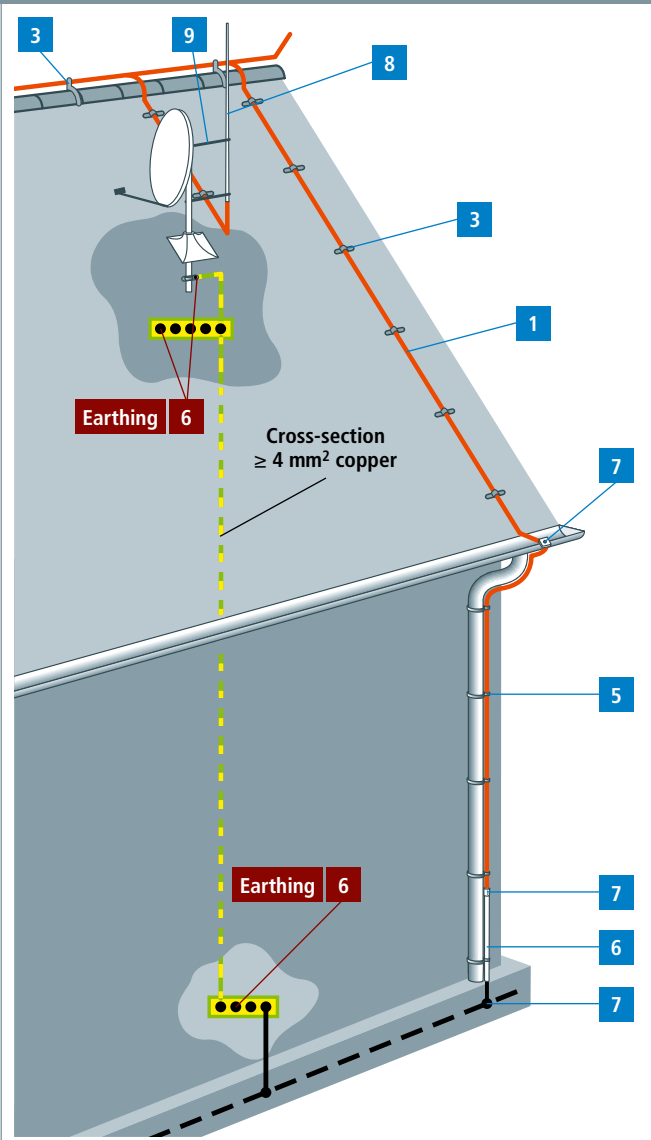

Equipotential bonding under the roofing without a lightning protection system

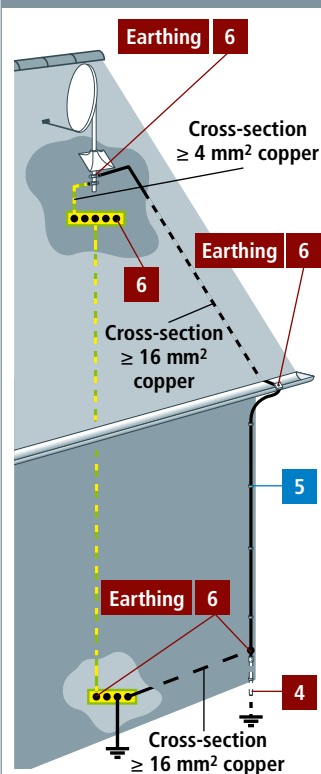

Equipotential bonding inside a building without a lightning protection system

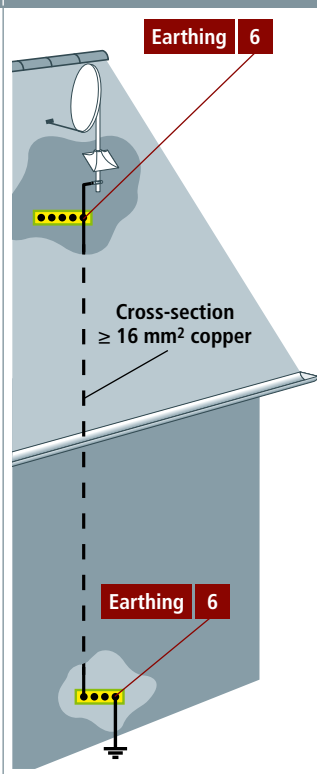

Product	Product name
1 	Round Wires Strips Cables see page 19
2 	Flat Roof – Roof Conductor Holders Bridging Braids see page 25
3 	Gable Roof – Roof Conductor Holders see page 31
4 	Metal Roof / Corrugated Sheet Roof – Roof Conductor Holders see page 41
5 	Down Conductor – Conductor Holders see page 45
6 	Earth Entries Connection Lugs Test Joint Boxes Conductor Holders see page 57
7 	Gutter Clamps Clamps Connectors see page 73
8 	Air-Termination Rods Air-Termination Tips Accessories see page 95
9 	Isolated Lightning Protection see page 115
10 	Reinforcement Technology see page 129

Air-termination System
Down Conductor

Product name	Product
Round Wires Strips Cables see page 19	1 
Flat Roof – Roof Conductor Holders Bridging Braids see page 25	2 
Gable Roof – Roof Conductor Holders see page 31	3 
Metal Roof / Corrugated Sheet Roof – Roof Conductor Holders see page 41	4 
Down Conductor – Conductor Holders see page 45	5 
Earth Entries Connection Lugs Test Joint Boxes Conductor Holders see page 57	6 
Gutter Clamps Clamps Connectors see page 73	7 
Air-Termination Rods Air-Termination Tips Accessories see page 95	8 
Isolated Lightning Protection see page 115	9 
Reinforcement Technology see page 129	10 

External lightning protection of an industrial building with a metal roof

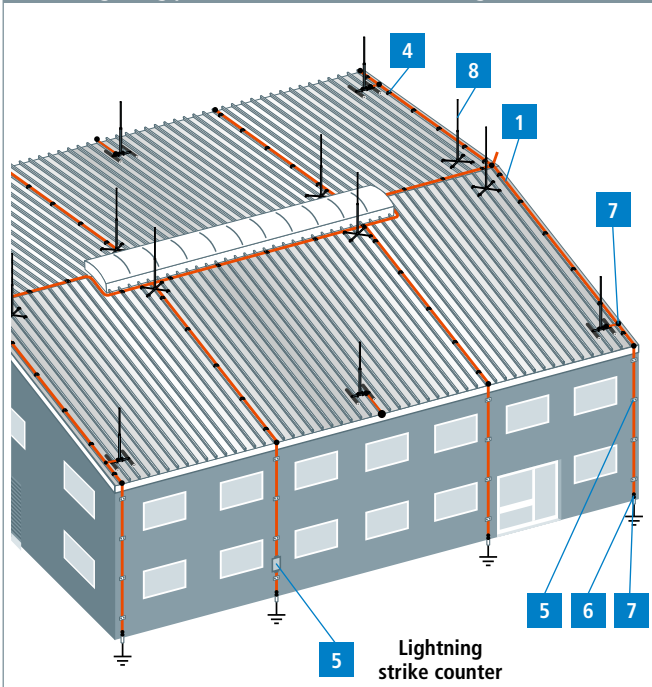

External lightning protection of a residential building with a thatched roof

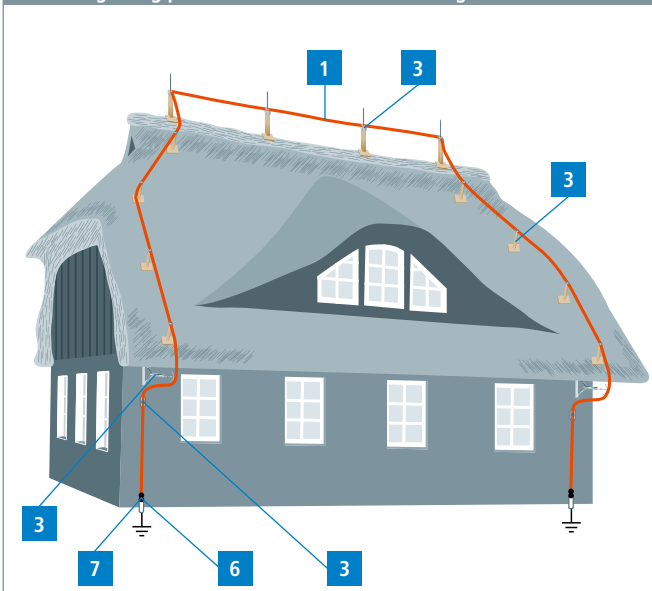

External lightning protection of a gas container, e.g. a fermenter

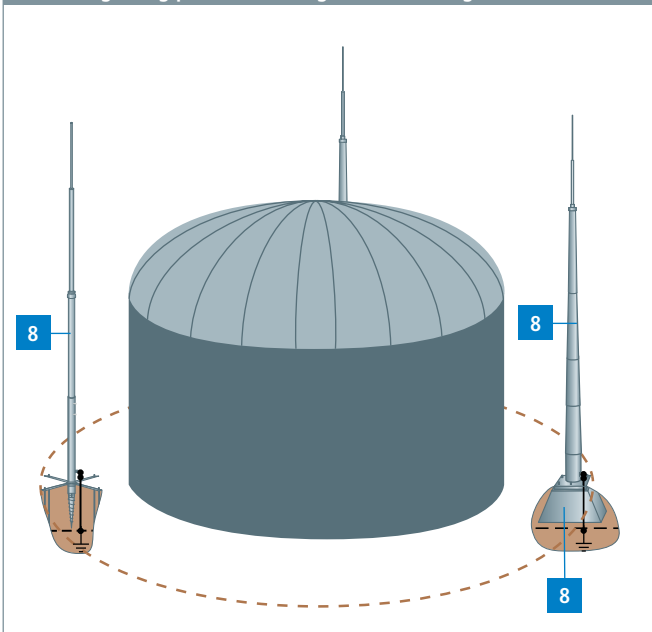

Round Wires

According to EN 62561-2, for use in lightning protection and earth-termination systems.

DEHNalu wire

Part No.	840 008	840 108	840 018
Diameter Ø conductor	8 mm	8 mm	8 mm
Cross-section	50 mm ²	50 mm ²	50 mm ²
Material	AlMgSi	AlMgSi	AlMgSi
Characteristics	semi-rigid	semi-rigid	soft, twistable
Standard	EN 62561-2	EN 62561-2	based on EN 62561-2
Coil weight	approx. 20 kg	approx. 3 kg	approx. 20 kg
PU	148 m	21 m	148 m

Part No.	840 028	840 010
Diameter Ø conductor	8 mm	10 mm
Cross-section	50 mm ²	78 mm ²
Material	AlMgSi	Al
Characteristics	soft, twistable	soft, twistable
Standard	based on EN 62561-2	EN 62561-2
Coil weight	approx. 3 kg	approx. 21 kg
PU	21 m	100 m

Note: Al and AlMgSi may not be installed directly (without a gap) on, in, or under plaster, mortar or concrete, and also not in soil.

DEHNalu wire with plastic sheath

Wire with plastic sheath (halogen-free, frost-resistant and UV-stabilised) as additional mechanical / corrosion protection, e.g. when installed behind facades.

Part No.	840 118	840 128
Diameter Ø conductor	8 mm	8 mm
Cross-section	50 mm ²	50 mm ²
Material	AlMgSi	Al
Characteristics	soft	soft
Standard	based on EN 62561-2	EN 62561-2
Outside diameter Ø	11 mm	11 mm
Material of sheath	plastic	plastic
Sheath thickness	1.5 mm	1.5 mm
Coil weight	approx. 20 kg	approx. 20 kg
PU	100 m	100 m

DEHNcupal wire

New composite material. Lighter than copper.

For use above ground as an an air-termination and down conductor, or for equipotential bonding.

Part No.	833 008
Diameter Ø conductor	8 mm
Cross-section	50 mm ²
Material	Al / Cu
Characteristics	soft, twistable
Standard	based on EN 62561-2
Cu sheath	min. 0.26 mm
Coil weight	approx. 20 kg
PU	110 m

Note: DEHNcupal wire can be twisted or straightened using a wire straightening device.

Copper wire

Part No.	830 008	830 108	830 038
Diameter Ø conductor	8 mm	8 mm	8 mm
Cross-section	50 mm ²	50 mm ²	50 mm ²
Material	Cu	Cu	Cu
Characteristics	soft F20	soft F20	semi-rigid F25
Standard	EN 62561-2	EN 62561-2	EN 62561-2
Short-circuit current (50 Hz) (1 s; ≤ 300 °C)	9.8 kA	9.8 kA	9.8 kA
Coil weight	approx. 45 kg	approx. 9 kg	approx. 45 kg
PU	100 m	20 m	100 m





Steel wire

With zinc coating $\geq 50 \mu\text{m}$ on average (approx. 350 g/m^2).

Part No.	800 008	800 010	800 310
Diameter \varnothing conductor	8 mm	10 mm	10 mm
Cross-section	50 mm ²	78 mm ²	78 mm ²
Material	St/tZn	St/tZn	St/tZn
Standard	based on EN 62561-2	based on EN 62561-2	based on EN 62561-2
Short-circuit current (50 Hz) (1 s; $\leq 300 \text{ }^\circ\text{C}$)	—	5.5 kA	5.5 kA
Coil weight	approx. 50 kg	approx. 50 kg	approx. 18.5 kg
PU	127 m	81 m	30 m

Steel wire, straightened, cut into bars

With zinc coating $\geq 50 \mu\text{m}$ on average (about 350 g/m^2). Suitable for installation in reinforcements (e.g. concrete supports).

Part No.	800 910	800 911
Diameter \varnothing conductor	10 mm	10 mm
Cross-section	78 mm ²	78 mm ²
Material	St/tZn	St/tZn
Standard	based on EN 62561-2	based on EN 62561-2
Short-circuit current (50 Hz) (1 s; $\leq 300 \text{ }^\circ\text{C}$)	5.5 kA	5.5 kA
Length	3 m	6 m
PU	10 pc(s)	1 pc(s)

Stainless steel wire

Stainless steel wires (Rd 10 mm) for use in soil have to be made of StSt (V4A) with a molybdenum content $> 2 \%$, e.g. 1.4571 or 1.4404, in accordance with EN 62561-2, IEC/EN 62305-3, DIN 18014 and DIN VDE 0151.

General technical data:				
Standard	based on EN 62561-2			
Part No.	860 908	860 920	860 950	860 910
Diameter \varnothing conductor	8 mm	10 mm	10 mm	10 mm
Cross-section	50 mm ²	78 mm ²	78 mm ²	78 mm ²
Material	StSt	StSt	StSt	StSt
Material No.	1.4301 / 1.4303	1.4301 / 1.4303	1.4301 / 1.4303	1.4301 / 1.4303
Short-circuit current (50 Hz) (1 s; $\leq 300 \text{ }^\circ\text{C}$)	—	—	—	—
Coil weight	approx. 50 kg	approx. 12 kg	approx. 31 kg	approx. 50 kg
PU	125 m	20 m	50 m	80 m
Part No.	860 008	860 010	860 020	860 050
Diameter \varnothing conductor	8 mm	10 mm	10 mm	10 mm
Cross-section	50 mm ²	78 mm ²	78 mm ²	78 mm ²
Material	StSt (V4A)	StSt (V4A)	StSt (V4A)	StSt (V4A)
Material No.	1.4571 / 1.4404	1.4571 / 1.4404	1.4571 / 1.4404	1.4571 / 1.4404
Short-circuit current (50 Hz) (1 s; $\leq 300 \text{ }^\circ\text{C}$)	—	2.9 kA	2.9 kA	2.9 kA
Coil weight	approx. 50 kg	approx. 50 kg	approx. 12 kg	approx. 31 kg
PU	125 m	80 m	20 m	50 m

Steel wire with plastic sheath

With plastic sheath as additional mechanical / corrosion protection, e.g. when connected to the lightning protection system. Suitable for installation on, in and under plaster, mortar or concrete.

Part No.	800 108	800 110
Diameter \varnothing conductor	8 mm	10 mm
Cross-section	50 mm ²	78 mm ²
Material	St/tZn	St/tZn
Standard	based on EN 62561-2	based on EN 62561-2
Outside diameter \varnothing	11 mm	13 mm
Material of sheath	plastic	plastic
Sheath thickness	1.5 mm	1.5 mm
Coil weight	approx. 33 kg	approx. 34 kg
PU	75 m	50 m

Conductor materials can only be supplied in the original coil weights. Further conductor materials as specified in the standard series EN 62561-2 are available on request.

Marker for Connection Lugs

Attached to round wires or strips to make them conspicuous (as required by DIN 18014) during the construction work.

Part No.	478 099
Material	PVC
Diameter Ø	70 mm
Fits on Fl	30 x 3.5 mm
Fits on Rd	10 mm
Colour	green ● / yellow ●
PU	20 pc(s)



Dripping Water Protective Collars

Prevents rain water from running down the round wire and soiling of the facade.

Part No.	276 056	276 057
Material	plastic	plastic
Conductor Rd	8 mm	8 mm
Colour	grey ●	brown ●
Diameter Ø	37 mm	37 mm
PU	100 pc(s)	1 pc(s)



Strips

According to EN 62561-2, for use in earth-termination and lightning protection systems as well as for ring equipotential bonding.

Steel strip

Zinc coating $\geq 70 \mu\text{m}$ on average (approx. 500 g/m²).

General technical data:			
Material	St/tZn		
Part No.	810 225	810 335	852 335
Width	20 mm	30 mm	30 mm
Thickness	2.5 mm	3.5 mm	3.5 mm
Cross-section	50 mm ²	105 mm ²	105 mm ²
Standard	based on EN 62561-2	EN 62561-2	EN 62561-2
Short-circuit current (50 Hz) (1 s; $\leq 300 \text{ }^\circ\text{C}$)	—	7.3 kA	7.3 kA
Coil weight	approx. 40 kg	approx. 42 kg	approx. 21 kg
PU	100 m	50 m	25 m
Part No.	810 304	810 404	810 405
Width	30 mm	40 mm	40 mm
Thickness	4 mm	4 mm	5 mm
Cross-section	120 mm ²	160 mm ²	200 mm ²
Standard	EN 62561-2	EN 62561-2	EN 62561-2
Short-circuit current (50 Hz) (1 s; $\leq 300 \text{ }^\circ\text{C}$)	8.4 kA	11.2 kA	14 kA
Coil weight	approx. 50 kg	approx. 50 kg	approx. 50 kg
PU	52 m	40 m	30 m



Copper strip

Part No.	831 225
Width	20 mm
Thickness	2.5 mm
Cross-section	50 mm ²
Material	Cu
Standard	EN 62561-2
Short-circuit current (50 Hz) (1 s; $\leq 300 \text{ }^\circ\text{C}$)	9.8 kA
Coil weight	approx. 45 kg
PU	100 m





Stainless steel strip

General technical data:			
Standard	EN 62561-2		
Part No.	860 925	860 900	860 325
Width	30 mm	30 mm	30 mm
Thickness	3.5 mm	3.5 mm	3.5 mm
Cross-section	105 mm ²	105 mm ²	105 mm ²
Material	StSt	StSt	StSt (V4A)
Material No.	1.4301 / 1.4303	1.4301 / 1.4303	1.4571 / 1.4404
Short-circuit current (50 Hz) (1 s; ≤ 300 °C)	—	—	3.9 kA
Coil weight	approx. 21 kg	approx. 49 kg	approx. 21 kg
PU	25 m	60 m	25 m
Part No.	860 335	860 404	860 405
Width	30 mm	40 mm	40 mm
Thickness	3.5 mm	4 mm	5 mm
Cross-section	105 mm ²	160 mm ²	200 mm ²
Material	StSt (V4A)	StSt (V4A)	StSt (V4A)
Material No.	1.4571 / 1.4404	1.4571 / 1.4404	1.4571 / 1.4404
Short-circuit current (50 Hz) (1 s; ≤ 300 °C)	3.9 kA	—	—
Coil weight	approx. 49 kg	approx. 50 kg	approx. 50 kg
PU	60 m	40 m	30 m



Strips in different dimensions and materials are available upon request.

Cables

For use in lightning protection and earth-termination systems.



Aluminium cable

e.g. for isolated air-termination systems (DEHNiso Combi).

Part No.	840 050
Cross-section	50 mm ²
Cable structure qty x Ø wire	19 x 1.8 mm
Material	Al
Standard	EN 62561-2
Outside diameter Ø	9 mm
Coil weight	approx. 13.5 kg
PU	100 m

Note: Al must not be installed directly (without distance) on, in or under plaster, mortar or concrete, and not in soil.



Steel cable

Part No.	801 050
Cross-section	42 mm ²
Cable structure qty x Ø wire	[6x] 19 x 0.65 mm
Material	St/gal Zn
Outside diameter Ø	10 mm
Coil weight	approx. 33 kg
PU	100 m



Stainless steel cable

e.g. for equipotential bonding.

Part No.	850 008	850 010
Cross-section	27 mm ²	42 mm ²
Cable structure qty x Ø wire	[7x] 19 x ca. 0.59 mm	[7x] 19 x ca. 0.68 mm
Material	StSt (V4A)	StSt (V4A)
Material No.	1.4571 / 1.4404	1.4571 / 1.4404
Outside diameter Ø	8 mm	10 mm
Coil weight	approx. 23.5 kg	approx. 39.5 kg
PU	100 m	100 m



Copper cable

General technical data:			
Material	Cu		
Standard	EN 62561-2		
Part No.	832 739	832 740	832 192
Cross-section	50 mm ²	50 mm ²	70 mm ²
Cable structure qty x Ø wire	19 x 1.8 mm	19 x 1.8 mm	19 x 2.1 mm
Outside diameter Ø	9 mm	9 mm	10.5 mm
Short-circuit current (50 Hz) (1 s; ≤ 300 °C)	9.8 kA	9.8 kA	13.6 kA
Coil weight	approx. 22 kg	approx. 44 kg	approx. 30 kg
PU	50 m	100 m	50 m
Part No.	832 193	832 095	832 120
Cross-section	70 mm ²	95 mm ²	120 mm ²
Cable structure qty x Ø wire	19 x 2.1 mm	19 x 2.5 mm	19 x 2.8 mm
Outside diameter Ø	10.5 mm	12.5 mm	14.5 mm
Short-circuit current (50 Hz) (1 s; ≤ 300 °C)	13.6 kA	18.5 kA	23.4 kA
Coil weight	approx. 60 kg	approx. 42 kg	approx. 53 kg
PU	100 m	50 m	50 m



Conductor material
1

Tinned copper cable

General technical data:			
Material	Cu/gal Sn		
Part No.	832 838	832 839	832 202
Cross-section	35 mm ²	50 mm ²	70 mm ²
Cable structure qty x Ø wire	7 x 2.5 mm	19 x 1.8 mm	19 x 2.1 mm
Standard	—	EN 62561-2	EN 62561-2
Outside diameter Ø	7.5 mm	9 mm	10.5 mm
Short-circuit current (50 Hz) (1 s; ≤ 150 °C)	5 kA	7.2 kA	10.1 kA
Coil weight	approx. 33 kg	approx. 44 kg	approx. 30 kg
PU	100 m	100 m	50 m
Part No.	832 292	832 295	832 320
Cross-section	70 mm ²	95 mm ²	120 mm ²
Cable structure qty x Ø wire	19 x 2.1 mm	19 x 2.5 mm	19 x 2.8 mm
Standard	EN 62561-2	EN 62561-2	EN 62561-2
Outside diameter Ø	10.5 mm	12.5 mm	14.5 mm
Short-circuit current (50 Hz) (1 s; ≤ 150 °C)	10.1 kA	13.8 kA	17.3 kA
Coil weight	approx. 60 kg	approx. 42 kg	approx. 53 kg
PU	100 m	50 m	50 m



Cables in different dimensions and materials are available upon request.

Different wire straightening devices on page 293





DEHN protects.

Roof Conductor Holders for Flat Roofs



Roof conductor holders for attaching round conductors and strips (with adapter) to flat roofs.

- Conductor holder with weather-resistant plastic support plate, UV-stabilised and halogen-free
- Frost-resistant concrete block in accordance with EN 1338 for paving stones, frost resistance tested according to EN 1340 (frost/dew test)
- Concrete block and support plate have to be recycled separately

Note: Information on whether the roof conductor holder or support plate material is compatible with the roof elements can be requested from DEHN.

Type FB2, with two conductor supports

Part No.	253 050	253 060
Conductor routing	loose	fixed
Material of conductor holder	plastic	plastic
Colour of conductor holder	black ●	black ●
Conductor support Rd	8 mm	8 mm
Weight	1 kg	1 kg
Block	concrete (C35/45)	concrete (C35/45)
Dimensions	141 x 86 x 70 mm	141 x 86 x 70 mm
PU	10 pc(s)	10 pc(s)



Type KF2, with two conductor supports

Clamped into roof sheeting strips (up to 5 mm thick) which are welded with or adhere to the roof sheeting.

Part No.	253 051
Conductor routing	loose
Material of conductor holder	plastic
Colour of conductor holder	black ●
Conductor support Rd	8 mm
Dimensions	141 x 86 x 70 mm
PU	100 pc(s)



Type FB, with one conductor support

Part No.	253 015
Conductor routing	loose
Material of conductor holder	plastic
Colour of conductor holder	black ●
Conductor support Rd	8 mm
Weight	1 kg
Block	concrete (C35/45)
Dimensions	100 x 100 x 70 mm
PU	10 pc(s)



Type KF, with one conductor support

Clamped into roof sheeting strips (up to 2.5 mm thick) which are welded with or adhere to the roof sheeting.

Part No.	253 030
Conductor routing	loose
Material of conductor holder	plastic
Colour of conductor holder	black ●
Conductor support Rd	8 mm
Dimensions	110 x 100 x 75 mm
PU	100 pc(s)



Separate plastic upper part for type KF (Part No. 253 016) is available upon request.

Accessories for Roof Conductor Holders for Flat Roofs

Adapter for round conductors for type FB and KF

Snapped onto roof conductor holders for conductors Rd 10 mm, loose conductor routing. Adapter for conductors Rd 6 mm (Part No. 253 022) is available upon request.

Part No.	253 023
Conductor support Rd	10 mm
Material	plastic
Colour	black ●
PU	50 pc(s)



Accessories for Roof Conductor Holders for Flat Roofs

Adapter for flat conductors for type FB and KF

Snapped onto roof conductor holders (Part No. 253 015) for flat conductors 30 mm, loose conductor leading.



Part No.	253 021
Conductor support Fl	30 mm
Material	plastic
Colour	black ●
PU	50 pc(s)

Cap for type FB and KF

Snapped onto roof conductor holders (Part No. 253 015) to better secure air-termination conductors installed on slanted roofs.



Part No.	253 025
Conductor support Rd	8 mm
Material	plastic
Colour	black ●
PU	50 pc(s)

Roof Conductor Holders for Flat Roofs with Fixing Holes

For installing air-termination systems on flat roofs and walls.

Type St/tZn, large

With conductor holder DEHNQUICK, fixed conductor routing, height up to the centre of the conductor of 60 mm.



Part No.	202 060
Material of roof conductor holder	St/tZn
Dimensions	100 x 100 mm
Fixing	[4x] Ø4 / [4x] Ø10 mm
Material of conductor holder	St/tZn
Conductor support Rd	6-10 mm
PU	1 pc(s)

Type St/tZn, small

With conductor holder DEHNQUICK, fixed conductor routing, height up to the centre of the conductor of 60 mm.



Part No.	202 030
Material of roof conductor holder	St/tZn
Dimensions	50 x 60 mm
Fixing	[4x] Ø5.2 mm
Material of conductor holder	St/tZn
Conductor support Rd	6-10 mm
PU	50 pc(s)

Round fixing plate, St/tZn, large

Plate with threaded bolt M8, e.g. for DEHNSnap or DEHNhold for use on, e.g. roofing felt, concrete, steel and brickwork.



Part No.	297 015
Material of roof conductor holder	St/tZn
Dimensions	approx. Ø100 mm
Fixing	[4x] Ø4 / [4x] Ø10 mm
PU	25 pc(s)

Round fixing plate, plastic, small

Plate with threaded bolt M8, e.g. for DEHNSnap or DEHNhold for use on, e.g. roofing felt, concrete, steel and brickwork.



Part No.	297 025
Material of roof conductor holder	plastic
Colour	grey ●
Dimensions	Ø40 mm
Fixing	[4x] Ø4 mm
PU	100 pc(s)

Roof Bushings

For leading down conductors through roofs and for sealing roofs.

For flat roofs

The max. processing temperature of +110 °C has to be observed during installation. In case of connection heights exceeding 100 mm, the roof bushing and conductor have to be wrapped in a self-adhesive universal sealing tape (aluminium fixing tape).

Part No.	552 030
Material	plastic
Colour	black ●
Bushing Rd	8 / 10 / 16 mm
Bushing Fl	20 x 2.5 / 30 x 3.5 mm
Diameter Ø	250 mm
PU	25 pc(s)



For tile and corrugated sheet roofs

Hole Ø16 mm.

Part No.	552 010
Hole	Ø16 mm
Material	plastic
Colour	black ●
Bushing Rd	8-10 mm
Diameter Ø	34 mm
PU	25 pc(s)



Expansion Pieces

For temperature-related length compensation of long conductors (provided that the conductor routing in the holders is loose).

Round design

For connection e.g. with MV clamp (Part No. 390 051).

Part No.	374 011
Material	Al
Dimensions	Ø8 mm
Length	approx. 395 mm
Standard	EN 62561-2
PU	25 pc(s)



Flat design

For connection e.g. with KS connector (Part No. 301 000).

Note: At cross points two expansion pieces can be connected with one M10 x 20 mm screw and nut.

Part No.	374 020
Material	Al
Dimensions	30 x 2 mm
Length	170 mm
Fixing	[2x] Ø11 mm
Central hole	Ø11 mm
Standard	EN 62561-1
PU	50 pc(s)

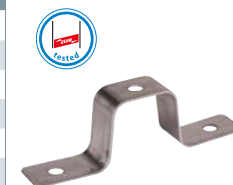

Bridging Brackets

For connection (riveting or screwing) of metal cladding.

Application note:

According to DIN EN 62305-3 Suppl. 1, four rivets Ø5 mm shall be used to connect material of ≥ 0.5 mm thickness, or two StSt self-tapping screws Ø6.3 mm (one on each side) for material of ≥ 2 mm thickness.

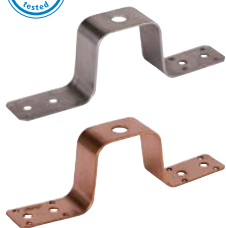

Short design with middle hole

Part No.	377 006	377 027
Material	Al	Cu
Dimensions	30 x 2 mm	28 x 2 mm
Length	170 mm	170 mm
Fixing	[8x] Ø5.2 / [4x] Ø6.5 mm	[8x] Ø5.2 / [4x] Ø6.5 mm
Middle hole	Ø11 mm	Ø11 mm
Standard	EN 62561-1	EN 62561-1
PU	50 pc(s)	50 pc(s)

Short design without middle hole

Part No.	377 016
Material	Al
Dimensions	30 x 2 mm
Length	170 mm
Fixing	[8x] Ø5.2 / [4x] Ø6.5 mm
Standard	EN 62561-1
PU	50 pc(s)

Long design with middle hole

Part No.	377 026
Material	Al
Dimensions	30 x 2 mm
Length	220 mm
Fixing	[8x] Ø5.2 / [4x] Ø6.5 mm
Middle hole	Ø11 mm
Standard	EN 62561-1
PU	50 pc(s)

Bridging brackets with middle hole may be combined with KS connectors (e.g. Part No. 301 019).

Bridging Brails

For connecting metal claddings (riveting or screwing) or as expansion compensation piece for round wires; connection e.g. by KS connector (Part No. 301 019).

Application note:

According to DIN EN 62305-3 Suppl. 1, four rivets Ø5 mm shall be used to connect material of ≥ 0.5 mm thickness, or two StSt tapping screws Ø6.3 mm (one on each side) for material of ≥ 2 mm thickness.



Short design

Part No.	377 015	377 007
Material	Al	Cu
Length (l _G)	180 mm	180 mm
Cross-section	50 mm ²	50 mm ²
Fixing	[8x] Ø5.2 / [2x] Ø10.5 mm	[8x] Ø5.2 / [2x] Ø10.5 mm
Fixing possibility	blind rivets / screws	blind rivets / screws
Standard	EN 62561-1	EN 62561-1
PU	10 pc(s)	10 pc(s)

Short design, fixed with drilling screws

Part No.	377 045
Material	Al
Length (l _G)	180 mm
Cross-section	50 mm ²
Fixing	[4x] Ø6.5 / [2x] Ø10.5 mm
Fixing possibility	drilling screws / screws
Standard	EN 62561-1
PU	100 pc(s)



Long design, with middle hole

Note: At cross points, two bridging braids can be connected with a M10 x 20 mm screw and nut.

Part No.	377 115	377 107
Material	Al	Cu
Length (l _G)	300 mm	300 mm
Cross-section	50 mm ²	50 mm ²
Fixing	[8x] Ø5.2 / [3x] Ø10.5 mm	[8x] Ø5.2 / [3x] Ø10.5 mm
Central hole Ø	10.5 mm	10.5 mm
Fixing possibility	blind rivets / screws	blind rivets / screws
Standard	EN 62561-1	EN 62561-1
PU	10 pc(s)	10 pc(s)



Bridging Cables

Bridging cables for connecting (screwing) / bridging metal cladding or for use as an expansion compensation piece for round wires; connection e.g. with KS connector (Part No. 301 019).

Application note:

According to DIN EN 62305-3 Suppl. 1, two rivets Ø6 mm shall be used to connect material of ≥ 0.5 mm thickness, or two StSt self-tapping screws Ø6.3 mm (on both sides) for material of ≥ 2 mm thickness.

Part No.	377 210	377 310	377 410	377 510
Length	200 mm	300 mm	400 mm	500 mm
Material of cable lug	Al	Al	Al	Al
Material of cable	Cu	Cu	Cu	Cu
Cross-section	16 mm ²	16 mm ²	16 mm ²	16 mm ²
Fixing	[4x] Ø6.5 / [2x] Ø10.5 mm	[4x] Ø6.5 / [2x] Ø10.5 mm	[4x] Ø6.5 / [2x] Ø10.5 mm	[4x] Ø6.5 / [2x] Ø10.5 mm
Insulation	rubber EM5 black	rubber EM5 black	rubber EM5 black	rubber EM5 black
Standard	EN 62561-1	EN 62561-1	EN 62561-1	EN 62561-1
PU	10 pc(s)	100 pc(s)	10 pc(s)	10 pc(s)



Drilling Screw

Self-tapping with hexagon head and collar, for connecting bridging brackets, braids or cables, e.g. to the metal capping of the roof parapet (for materials of ≥ 2 mm thickness).

Part No.	528 619
Material	StSt
Dimensions	6.3 x 19 mm
Head	width across flats 10
Standard	DIN 7504
PU	1 pc(s)



Blind Rivet

With StSt pin for connecting bridging brackets, braids or cables, according to DIN EN 62305-3 Suppl. 1.



Part No.	528 610
Material	Al / StSt
Head	Ø5 mm
Length	10 mm
Standard	similar to EN15979 (DIN 7337)
PU	500 pc(s)

Bridging Cable with Seam Clamps

- For connecting or bridging metal cladding (e.g. parts of the capping of the roof parapet) without drilling
- With one clamping plate each, e.g. for connection to the air-termination system and erection of air-termination tips (Rd 8-10 mm)
- For the seams of the capping of the roof parapet with an angle of 0-45° and a max. length up to 18 mm

Your benefit: The design avoids soiling by drilling chips!



Part No.	365 419
Clamping range of seam	0.7-10 mm
Material of seam clamps	StSt
Length	200 mm
Material of cable	Cu
Cross-section	16 mm ²
Standard	EN 62561-1
PU	5 pc(s)

Connection Kit for Safety Rope System



System for connecting the safety rope systems on roofs with the air-termination system; with premounted connection lug for the safety rope and clamping frame.

Rope diameter 6 mm



Part No.	365 509
Clamping range of connection lug	Ø6 mm
Rope structure	7 x 7 / 7 x 19 mm
Material of connection lug	StSt
Clamping piece support Rd	6-10 mm
Length	1000 mm
Material of rope	Cu
Cross-section	16 mm ²
Temperature range	-40 °C ... +80 °C
Insulation	rubber EM5 black
Standard	EN 62561-1
PU	1 pc(s)

Rope diameter 8 mm



Part No.	365 519
Clamping range of connection lug	Ø8 mm
Rope structure	7 x 7 / 7 x 19 mm
Material of connection lug	StSt
Clamping piece support Rd	6-10 mm
Length	1000 mm
Material of rope	Cu
Cross-section	16 mm ²
Temperature range	-40 °C ... +80 °C
Insulation	rubber EM5 black
Standard	EN 62561-1
PU	1 pc(s)

Roof Conductor Holders with Tension Spring for Ridge and Hip Tiles

For fixing air-termination conductors on the ridge, e.g. of tile roofs.

SPANNsnap light

Fixed with a StSt tension spring, with conductor holder DEHNSnap, loose conductor routing, laterally adjustable.

Part No.	204 469	204 449
Material of roof conductor holder	StSt	StSt
Clamping range of ridge tile width	180-280 mm	180-280 mm
Height of conductor holder	16 mm	36 mm
Material of conductor holder	plastic	plastic
Colour of conductor holder	grey ●	grey ●
Conductor support Rd	8 mm	8 mm
PU	25 pc(s)	25 pc(s)

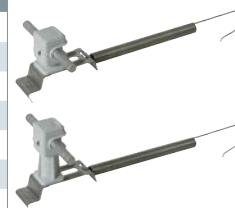

SPANNsnap

Fixed with a StSt tension spring, with conductor holder DEHNSnap, loose conductor routing, laterally adjustable.

Part No.	204 269	204 267	204 249	204 247
Material of roof conductor holder	StSt	Cu	StSt	Cu
Clamping range of ridge tile width	180-280 mm	180-280 mm	180-280 mm	180-280 mm
Height of conductor holder	16 mm	16 mm	36 mm	36 mm
Material of conductor holder	plastic	plastic	plastic	plastic
Colour of conductor holder	grey ●	brown ●	grey ●	brown ●
Conductor support Rd	8 mm	8 mm	8 mm	8 mm
PU	25 pc(s)	25 pc(s)	25 pc(s)	25 pc(s)

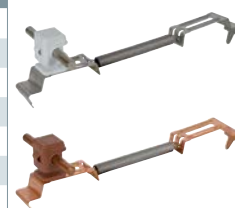

SPANNgrip light

Fixed with a StSt tension spring, with conductor holder DEHNSnap, loose conductor routing, laterally adjustable.

Part No.	206 439	206 449
Material of roof conductor holder	StSt	StSt
Clamping range of ridge tile width	180-280 mm	180-280 mm
Height of conductor holder	20 mm	32 mm
Material of conductor holder	StSt	StSt
Conductor support Rd	8 mm	8 mm
Standard	EN 62561-4	EN 62561-4
PU	25 pc(s)	25 pc(s)



SPANNgrip

Fixed with a StSt tension spring, with conductor holder DEHNSnap, loose conductor routing, laterally adjustable.

Part No.	206 239	206 237	206 249	206 247
Material of roof conductor holder	StSt	Cu	StSt	Cu
Clamping range of ridge tile width	180-280 mm	180-280 mm	180-280 mm	180-280 mm
Height of conductor holder	20 mm	20 mm	32 mm	32 mm
Material of conductor holder	StSt	Cu	StSt	Cu
Conductor support Rd	8 mm	8 mm	8 mm	8 mm
Standard	EN 62561-4	EN 62561-4	EN 62561-4	EN 62561-4
PU	25 pc(s)	25 pc(s)	25 pc(s)	25 pc(s)

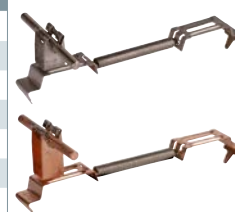

Roof Conductor Holders Adjustable for Ridge and Hip Tiles

For fixing air-termination conductors on the ridge, e.g. of tile roofs.

Steplessly adjustable with conductor holder DEHNSnap

Loose conductor routing, laterally adjustable (top centre to the bottom).

General technical data:	
Clamping range	180-280 mm
Material of conductor holder	plastic
Conductor support Rd	8 mm
Length of clamping claw	23 mm

Part No.	204 109	204 911	204 107
Material of roof conductor holder	StSt	StSt	Cu
Height of conductor holder	16 mm	16 mm	16 mm
Colour of conductor holder	grey ●	brown ●	brown ●
PU	25 pc(s)	25 pc(s)	25 pc(s)

Part No.	204 129	204 913	204 127
Material of roof conductor holder	StSt	StSt	Cu
Height of conductor holder	36 mm	36 mm	36 mm
Colour of conductor holder	grey ●	brown ●	brown ●
PU	25 pc(s)	25 pc(s)	25 pc(s)



Steplessly adjustable with conductor holder DEHNgrip

Loose conductor routing, laterally adjustable (top centre to the bottom).

General technical data:	
Clamping range	180-280 mm
Conductor support Rd	8 mm
Standard	EN 62561-4

Part No.	206 109	206 809	206 807
Material of roof conductor holder	StSt	StSt	Cu
Height of conductor holder	20 mm	20 mm	20 mm
Material of conductor holder	StSt	StSt	Cu
Length of clamping claw	23 mm	15 mm	15 mm
PU	25 pc(s)	25 pc(s)	25 pc(s)

Part No.	206 817	206 819
Material of roof conductor holder	Cu	StSt
Height of conductor holder	32 mm	32 mm
Material of conductor holder	Cu	StSt
Length of clamping claw	15 mm	15 mm
PU	25 pc(s)	25 pc(s)



Adjustable in steps with conductor holder DEHNquick

Fixed conductor routing.

General technical data:	
Conductor support Rd	6-10 mm
Length of clamping claw	24 mm

Part No.	202 020	202 021	202 900
Material of roof conductor holder	St/tZn	St/tZn	StSt
Clamping range	120-240 mm	200-280 mm	120-240 mm
Material of conductor holder	St/tZn	St/tZn	StSt
PU	25 pc(s)	1 pc(s)	1 pc(s)

Part No.	202 027	202 227
Material of roof conductor holder	Cu	Cu
Clamping range	120-240 mm	200-280 mm
Material of conductor holder	Cu	Cu
PU	1 pc(s)	25 pc(s)



Roof Conductor Holders for Ridge and Hip Tiles

For fixing air-termination conductors on the ridge.

FIRSTsnap

Attached to the ridge tile clip of dry ridges, with conductor holder DEHNsnap, loose conductor routing.

Part No.	204 029	204 039
Material of roof conductor holder	StSt	StSt
Height of conductor holder	16 mm	16 mm
Material of conductor holder	plastic	plastic
Colour of conductor holder	grey ●	brown ●
Conductor support Rd	8 mm	8 mm
PU	50 pc(s)	50 pc(s)



Two screw clamp with spacer and elastic sealing

For tiled, slated and corrugated sheet roofs, with weather-resistant spacer and elastic sealing, fixed conductor routing.

Part No.	216 000
Material of roof conductor holder	plastic
Hole	Ø12 mm
Material of conductor holder	St/tZn
Conductor support Rd	7-10 mm
Conductor support Fl	20 mm
PU	25 pc(s)



Roof Conductor Holders with Angled, Flexible Brace for Roof Surfaces

For hanging into roof tiles, with a flexible brace made of thin StSt (0.3 mm) which moulds itself to the grooves of the tile.

FLEXIsnap

Fixed to grooved tiles using the flexible brace, loose conductor routing.

Part No.	204 935	204 936	204 937	204 938
Material of roof conductor holder	StSt	StSt	StSt	StSt
Length of brace	170 mm	170 mm	170 mm	170 mm
Height of conductor holder	16 mm	16 mm	36 mm	36 mm
Material of conductor holder	plastic	plastic	plastic	plastic
Colour of conductor holder	grey ●	brown ●	grey ●	brown ●
Conductor support Rd	8 mm	8 mm	8 mm	8 mm
PU	1 pc(s)	50 pc(s)	50 pc(s)	50 pc(s)



FLEXIgrip

Fixed to grooved tiles using the flexible brace, loose conductor routing.

Part No.	204 949	204 957
Material of roof conductor holder	StSt	StSt
Length of brace	170 mm	170 mm
Height of conductor holder	32 mm	32 mm
Material of conductor holder	StSt	Cu
Conductor support Rd	8 mm	8 mm
Standard	EN 62561-4	EN 62561-4
PU	50 pc(s)	50 pc(s)



Roof Conductor Holders with Embossed Brace for Roof Surfaces

For fixing air-termination and down conductors.

UNIsnap height 16 mm

With prepunched points for bending it and hooking it into roof tiles or battens, with conductor holder DEHNSnap, loose conductor routing.

General technical data:	
Height of conductor holder	16 mm
Material of conductor holder	plastic
Conductor support Rd	8 mm

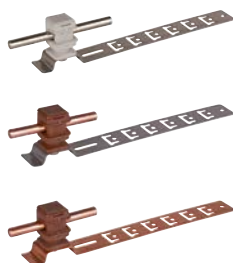

Part No.	204 149	204 921	204 147
Material of roof conductor holder	StSt	StSt	Cu
Length of brace	205 mm	205 mm	205 mm
Colour of conductor holder	grey ●	brown ●	brown ●
PU	50 pc(s)	1 pc(s)	50 pc(s)

Part No.	204 159	204 157	204 169
Material of roof conductor holder	StSt	Cu	StSt
Length of brace	335 mm	335 mm	475 mm
Colour of conductor holder	grey ●	brown ●	grey ●
PU	50 pc(s)	50 pc(s)	1 pc(s)

UNIsnap height 36 mm

With prepunched points, for bending it and hooking it into roof tiles or battens, with conductor holder DEHNSnap, loose conductor routing.

General technical data:	
Height of conductor holder	36 mm
Material of conductor holder	plastic
Conductor support Rd	8 mm

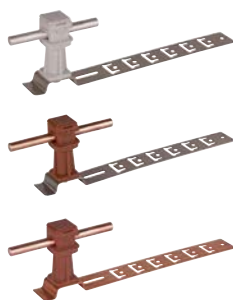

Part No.	204 179	204 924	204 177	204 189
Material of roof conductor holder	StSt	StSt	Cu	StSt
Length of brace	205 mm	205 mm	205 mm	335 mm
Colour of conductor holder	grey ●	brown ●	brown ●	grey ●
PU	50 pc(s)	50 pc(s)	50 pc(s)	50 pc(s)

Part No.	204 925	204 187	204 199	204 197
Material of roof conductor holder	StSt	Cu	StSt	Cu
Length of brace	335 mm	335 mm	475 mm	475 mm
Colour of conductor holder	brown ●	brown ●	grey ●	brown ●
PU	50 pc(s)	50 pc(s)	50 pc(s)	1 pc(s)

UNIsnap with clamping part

With prepunched points for bending it and hooking it into roof tiles or battens, with additional clamping part e.g. for slated roofs, with conductor holder DEHNSnap, loose conductor routing.



Part No.	204 089
Material of roof conductor holder	StSt
Length of brace	205 mm
Height of conductor holder	16 mm
Material of conductor holder	plastic
Colour of conductor holder	grey ●
Conductor support Rd	8 mm
PU	1 pc(s)

DEHNSnap with Al base brace

Moulds itself to the grooves of the tile, with conductor holder DEHNSnap, loose conductor routing.



Part No.	204 170	204 171
Material of roof conductor holder	Al	Al
Length of brace	205 mm	205 mm
Height of conductor holder	36 mm	36 mm
Material of conductor holder	plastic	plastic
Colour of conductor holder	grey ●	brown ●
Conductor support Rd	8 mm	8 mm
PU	50 pc(s)	50 pc(s)

UNIgrip height 20 mm

With prepunched points for bending it and hooking it on roof tiles or battens, with conductor holder DEHNgrip, loose conductor routing.

General technical data:	
Height of conductor holder	20 mm
Conductor support Rd	8 mm
Standard	EN 62561-4

Part No.	206 209	206 207	206 219
Material of roof conductor holder	StSt	Cu	StSt
Length of brace	205 mm	205 mm	335 mm
Material of conductor holder	StSt	Cu	StSt
PU	50 pc(s)	50 pc(s)	50 pc(s)

Part No.	206 217	206 229	206 227
Material of roof conductor holder	Cu	StSt	Cu
Length of brace	335 mm	475 mm	475 mm
Material of conductor holder	Cu	StSt	Cu
PU	50 pc(s)	50 pc(s)	1 pc(s)



UNIgrip height 32 mm

With prepunched points for bending it and hooking it on roof tiles or battens, with conductor holder DEHNgrip, loose conductor routing.

Part No.	206 309	206 319	206 329
Material of roof conductor holder	StSt	StSt	StSt
Length of brace	205 mm	335 mm	475 mm
Height of conductor holder	32 mm	32 mm	32 mm
Material of conductor holder	StSt	StSt	StSt
Conductor support Rd	8 mm	8 mm	8 mm
Standard	EN 62561-4	EN 62561-4	EN 62561-4
PU	50 pc(s)	50 pc(s)	50 pc(s)



UNIgrip with clamping part, height 20 mm

With prepunched points for bending it and hooking it into roof tiles or battens, with additional clamping part, e.g. for slated roofs, with conductor holder DEHNgrip, loose conductor routing.

Part No.	206 289
Material of roof conductor holder	StSt
Length of brace	205 mm
Height of conductor holder	20 mm
Material of conductor holder	StSt
Conductor support Rd	8 mm
Standard	EN 62561-4
PU	50 pc(s)



DEHNgrip with Al brace

Moulds itself to the grooves of the tile, with conductor holder DEHNgrip, loose conductor routing.

Part No.	206 170	206 171
Material of roof conductor holder	Al	Al
Length of brace	205 mm	205 mm
Height of conductor holder	20 mm	32 mm
Material of conductor holder	StSt	StSt
Conductor support Rd	8 mm	8 mm
Standard	EN 62561-4	EN 62561-4
PU	50 pc(s)	50 pc(s)



Roof Conductor Holders with Brace for Roof Surfaces

Inserted on tiled, slated and roofing felt roofs.

Straight

Straight, with conductor holder DEHNquick, for conductors Rd 6-10 mm, fixed conductor routing.

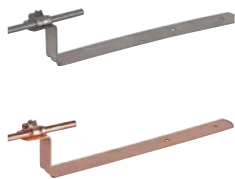

Part No.	202 040	202 902	202 037
Material of roof conductor holder	St/tZn	StSt	Cu
Height of brace	55 mm	55 mm	55 mm
Length of brace	260 / 2 mm	260 / 1 mm	260 / 2 mm
Material of conductor holder	St/tZn	StSt	Cu
Conductor support Rd	6-10 mm	6-10 mm	6-10 mm
PU	50 pc(s)	50 pc(s)	50 pc(s)

Cranked

With conductor holder DEHNquick, fixed conductor routing.

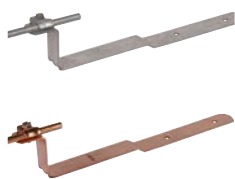

Part No.	202 010	202 901	202 017
Material of roof conductor holder	St/tZn	StSt	Cu
Height of brace	55 mm	55 mm	55 mm
Length of brace	260 / 2 mm	260 / 1 mm	260 / 2 mm
Material of conductor holder	St/tZn	StSt	Cu
Conductor support Rd	6-10 mm	6-10 mm	6-10 mm
PU	50 pc(s)	50 pc(s)	1 pc(s)

Roof Conductor Holders with Angled Brace for Roof Surfaces

Hung into the roof tiles.

With conductor holder DEHNSnap

Loose conductor routing.



Part No.	204 359
Material of roof conductor holder	StSt
Length of brace	169 mm
Height of conductor holder	16 mm
Material of conductor holder	plastic
Colour of conductor holder	grey ●
Conductor support Rd	8 mm
PU	1 pc(s)

With conductor holder DEHNgrip

Loose conductor routing.



Part No.	206 359
Material of roof conductor holder	StSt
Length of brace	169 mm
Height of conductor holder	20 mm
Material of conductor holder	StSt
Conductor support Rd	8 mm
Standard	EN 62561-4
PU	50 pc(s)

With conductor holder DEHNquick

Hung into roof tiles or battens, fixed conductor routing (lengthwise or crosswise).



Part No.	202 050	202 080
Material of roof conductor holder	St/tZn	St/tZn
Length of brace	115 mm	410 mm
Material of conductor holder	St/tZn	St/tZn
Conductor support Rd	6-10 mm	6-10 mm
PU	25 pc(s)	50 pc(s)

Roof Conductor Holders with Clamping Device for Roof Surfaces

For fixing air-termination conductors and down conductors.

PLATTENsnap

Fixed on overlapping constructions, with conductor holder DEHNsnap, loose conductor routing.

Part No.	204 069	204 079
Material of roof conductor holder	StSt	StSt
Clamping range	4-6 mm	4-6 mm
Height of conductor holder	16 mm	16 mm
Material of conductor holder	plastic	plastic
Colour of conductor holder	grey ●	brown ●
Conductor support Rd	8 mm	8 mm
PU	50 pc(s)	50 pc(s)



ZIEGELsnap

Fixed between flat tiles (pantiles) and slabs, with conductor holder DEHNsnap, loose conductor routing.

Part No.	204 049	204 059
Material of roof conductor holder	StSt	StSt
Clamping range	4-16 mm	4-16 mm
Height of conductor holder	16 mm	16 mm
Material of conductor holder	plastic	plastic
Colour of conductor holder	grey ●	brown ●
Conductor support Rd	8 mm	8 mm
PU	50 pc(s)	50 pc(s)



ZIEGELgrip

Fixed between flat tiles (pantiles) and slabs, with conductor holder DEHNgrip, loose conductor routing.

Part No.	206 049
Material of roof conductor holder	StSt
Clamping range	4-16 mm
Height of conductor holder	20 mm
Material of conductor holder	StSt
Conductor support Rd	8 mm
Standard	EN 62561-4
PU	50 pc(s)



DEHNgrip for bitumen shingles

As well as for roof and wall slabs, loose conductor routing.

Part No.	206 389	206 399
Material of roof conductor holder	StSt	StSt
Clamping range	2-8 mm	8-18 mm
Height of conductor holder	20 mm	20 mm
Material of conductor holder	StSt	StSt
Conductor support Rd	8 mm	8 mm
Standard	EN 62561-4	EN 62561-4
PU	50 pc(s)	50 pc(s)



Roof Conductor Holders with Preformed Brace for Roof Surfaces

Hung onto the groove of roof tiles.

Hung onto the lower groove, with conductor holder DEHNgrip

Loose conductor routing.



Part No.	206 349
Material of roof conductor holder	StSt
Length of brace	103 mm
Height of conductor holder	20 mm
Material of conductor holder	StSt
Conductor support Rd	8 mm
Standard	EN 62561-4
PU	50 pc(s)

Hung onto the lower groove, with conductor holder DEHNSnap

Hung onto the lower groove of pantiles, with conductor holder DEHNSnap, loose conductor routing, brace length 90 mm.



Part No.	204 229	204 239
Material of roof conductor holder	StSt	StSt
Length of brace	90 mm	90 mm
Height of conductor holder	36 mm	36 mm
Material of conductor holder	plastic	plastic
Colour of conductor holder	grey ●	brown ●
Conductor support Rd	8 mm	8 mm
PU	50 pc(s)	50 pc(s)

Hung onto the upper groove, with conductor holder DEHNgrip

Hung onto the groove of pantiles, with conductor holder DEHNgrip, loose conductor routing, brace length 87 mm.



Part No.	206 369
Material of roof conductor holder	StSt
Length of brace	87 mm
Height of conductor holder	20 mm
Material of conductor holder	StSt
Conductor support Rd	8 mm
Standard	EN 62561-4
PU	50 pc(s)

Components for Buildings with Thatched Roof

Lightning protection system components for buildings with thatched roofs. Air-termination conductors on thatched roofs have to be installed at a distance to the roof, e.g. on isolating supports. Certain distances also have to be kept to the eaves.

The span width for ridge conductors is approx. 15 m and for down conductors approx. 10 m without additional supports. Span stakes have to be fastened to the roof construction (rafters and crossbars) using anchor bolts and flat washers.

Today an isolated (HVI) lightning protection system is often used as an external lightning protection system for buildings with thatched roofs (see page 169 / 170).



Wooden stake

With rain shelter, suitable for clamping cap (Part No. 146 309).

Part No.	145 241
Material	oak (impregnated)
Dimensions (l x w x h)	90 x 90 x 2400 mm
PU	1 pc(s)



Clamping cap

Fixed to wooden stakes (Part No. 145 241).

With air-termination tip (length 300 mm, Ø10 mm, StSt).

Part No.	146 309
Material	StSt
Support Rd	7-10 mm
PU	1 pc(s)



Roof conductor support

With conductor holder.

Part No.	240 000
Material	oak (impregnated)
Dimensions (l x w x h)	134 x 300 x 598 mm
Support Rd	6-10 mm
PU	1 pc(s)



Eaves supports St/tZn / StSt

For spanning conductors/cables over it.

Distance between the wall and conductors is adjustable.

Part No.	239 000	239 001	239 009	239 019
Material	St/tZn	St/tZn	StSt	StSt
Adjustable range	1.05-1.20 m	1.40-1.55 m	1.25-1.55 m	1.45-1.75 m
Support Rd	7-10 mm	7-10 mm	7-10 mm	7-10 mm
PU	1 pc(s)	1 pc(s)	1 pc(s)	1 pc(s)



Anchoring block

To fix the conductors / cables on the wall.

Part No.	241 009
Material	StSt
Dimensions (l x w x d)	150 x 40 x 6 mm
Support Rd	8 mm
PU	20 pc(s)





DEHN protects.

Roof Conductor Holders for Metal Roofs

For fixing additional air-termination systems on metal roofs.

When using two roof conductor holders (clamps / clamping pieces) which have been tested for the respective roof profile, a lightning current carrying capability of 100 kA (10/350 µs) is provided.

For roofs with round standing seam, with clamping piece

Part No.	223 010	223 040
Material of roof conductor holder	StSt	Al
Clamping range	Ø20-25 mm	Ø20-25 mm
Material of conductor holder	StSt	Al
Conductor support Rd	6-10 mm	6-10 mm
Conductor routing	fixed	fixed
Standard	EN 62561-1	EN 62561-1
PU	50 pc(s)	50 pc(s)



For roofs with round standing seam, with DEHNgrip

Loose conductor routing.

Part No.	223 011	223 041
Material of roof conductor holder	StSt	Al
Clamping range	Ø20-25 mm	Ø20-25 mm
Height of conductor holder	20 mm	20 mm
Material of conductor holder	StSt	StSt
Conductor support Rd	8 mm	8 mm
Conductor routing	loose	loose
Standard	EN 62561-4	EN 62561-4
PU	50 pc(s)	50 pc(s)



For roofs with clamping seam, with clamping piece (e.g. RIB ROOF Speed 500 by Zambelli)

Part No.	223 070
Material of roof conductor holder	Al
Clamping range	approx. 18 / 22 mm
Material of conductor holder	Al
Conductor support Rd	6-10 mm
Conductor routing	fixed
Standard	EN 62561-1
PU	50 pc(s)



For roofs with standing seam, with clamping piece

Part No.	365 059
Material of roof conductor holder	StSt
Clamping range	0.7-8 mm
Material of conductor holder	StSt
Conductor support Rd	6-10 mm
Conductor routing	fixed
Standard	EN 62561-1
PU	50 pc(s)



For roofs with standing seam, with DEHNgrip

Part No.	223 031
Material of roof conductor holder	StSt
Clamping range	0.7-8 mm
Height of conductor holder	20 mm
Material of conductor holder	StSt
Conductor support Rd	8 mm
Conductor routing	loose
Standard	EN 62561-4
PU	50 pc(s)



For trapezoidal roofs, with clamping piece

Hung into the fixing screws of the roof.



Part No.	223 020
Material of roof conductor holder	StSt
Material of conductor holder	StSt
Conductor support Rd	6-10 mm
Conductor routing	fixed
Standard	EN 62561-1
PU	50 pc(s)

For trapezoidal roofs, with DEHNgrip

Hung into the fixing screws of the roof.



Part No.	223 021
Material of roof conductor holder	StSt
Height of conductor holder	20 mm
Material of conductor holder	StSt
Conductor support Rd	8 mm
Conductor routing	loose
Standard	EN 62561-4
PU	50 pc(s)

Roof Conductor Holders with Adhesive Pad



For installing air-termination systems, e.g. on trapezoidal roofs. The conductor holder can be used on smooth (unstructured) surfaces such as metal roofs / metal surfaces. The conductor holders are stuck to the roof (remove protective backing).

With conductor holder DEHNSnap



Part No.	297 110
Material of roof conductor holder	plastic
Colour of roof conductor holder	grey ●
Material of conductor holder	plastic
Conductor support Rd	8 mm
Height of conductor holder	36 mm
Colour of conductor holder	grey ●
Conductor routing	loose
Dimensions	Ø67 mm
PU	50 pc(s)

With conductor holder DEHNgrip



Part No.	297 120
Material of roof conductor holder	plastic
Colour of roof conductor holder	grey ●
Material of conductor holder	StSt
Conductor support Rd	8 mm
Height of conductor holder	32 mm
Conductor routing	loose
Dimensions	Ø67 mm
Standard	EN 62561-4
PU	50 pc(s)

Accessory for Roof Conductor Holders with Adhesive Pad

Special cleaner

Apply with a clean cloth to clean the surface before sticking on the roof conductor holder. 1 litre is sufficient for approx. 1000 adhesive pads.

Rating according to Regulation (EC) No. 1272/2008 [CLP]

- Flam. Liq. 2 / H225; flammable liquids; liquid and vapour easily flammable
- Eye Irrit. 2 / H319; serious eye damage/irritation; causes serious eye irritation
- STOT SE 3 / H336; specific target organ toxicity (one-time exposition); may cause drowsiness and dizziness

Dangerous goods regulations only allow transportation in Germany and Austria. Alternatively use ISOPROPYL ALCOHOL 99.1 to 99.9% (CAS - NO. 67-63-0).



Part No.	297 199
Application	For roof conductor holders with adhesive pad
PU	1 litre

Roof Conductor Holders for Corrugated Sheet Roofs

For installing ridge conductors and conductors on the roof surface. Corrugations 177 mm (profile 5) and 130 mm (profile 8).

For corrugated sheet roofs (profile 5), with DEHNquick

For installation on the roof surface.

Part No.	202 005
Material of roof conductor holder	St/tZn
Material of conductor holder	St/tZn
Conductor support Rd	6-10 mm
Conductor routing	fixed
PU	50 pc(s)



For corrugated sheet roofs (profile 5), with DEHNgrip

For installation on the roof surface.

Part No.	206 105
Material of roof conductor holder	St/tZn
Height of conductor holder	20 mm
Material of conductor holder	StSt
Conductor support Rd	8 mm
Conductor routing	loose
Standard	EN 62561-4
PU	50 pc(s)



For corrugated sheet roofs (profile 5 and profile 8), with DEHNquick

For installing ridge conductors and conductors on the roof surface, angled design.

Part No.	202 015
Material of roof conductor holder	St/tZn
Material of conductor holder	St/tZn
Conductor support Rd	6-10 mm
Conductor routing	fixed
PU	50 pc(s)



For corrugated sheet roofs (profile 5 and profile 8), with DEHNquick

For installing ridge conductors and conductors on the roof surface, angled design.

Part No.	202 906
Material of roof conductor holder	StSt
Material of conductor holder	StSt
Conductor support Rd	6-10 mm
Conductor routing	fixed
PU	50 pc(s)



For corrugated sheet roofs (profile 5 and profile 8), with DEHNgrip

For installing ridge conductors and conductors on the roof surface, straight design.

Part No.	206 339
Material of roof conductor holder	StSt
Height of conductor holder	20 mm
Material of conductor holder	StSt
Conductor support Rd	8 mm
Conductor routing	loose
Standard	EN 62561-4
PU	50 pc(s)



For corrugated sheet roofs (profile 5 and profile 8), with DEHNSnap

For installing ridge conductors and conductors on the roof surface, straight design.

Part No.	204 906	204 916
Material of roof conductor holder	StSt	StSt
Height of conductor holder	16 mm	16 mm
Material of conductor holder	plastic	plastic
Colour of conductor holder	grey ●	brown ●
Conductor support Rd	8 mm	8 mm
Conductor routing	loose	loose
PU	50 pc(s)	50 pc(s)





DEHN protects.

Conductor Holders DEHNgrip

Screwless StSt holder system with loose conductor routing.

Height 20 mm

Part No.	207 019	207 009	207 017	207 007
Thread of conductor holder	M6	—	M6	—
Hole of conductor holder	—	Ø7.8 mm	—	Ø7.8 mm
Material of conductor holder	StSt	StSt	Cu	Cu
Conductor support Rd	8 mm	8 mm	8 mm	8 mm
Standard	EN 62561-4	EN 62561-4	EN 62561-4	EN 62561-4
PU	50 pc(s)	50 pc(s)	50 pc(s)	50 pc(s)



Height 32 mm

Part No.	207 039	207 029	207 037	207 027
Thread of conductor holder	M6	—	M6	—
Hole of conductor holder	—	Ø7.8 mm	—	Ø7.8 mm
Material of conductor holder	StSt	StSt	Cu	Cu
Conductor support Rd	8 mm	8 mm	8 mm	8 mm
Standard	EN 62561-4	EN 62561-4	EN 62561-4	EN 62561-4
PU	50 pc(s)	50 pc(s)	50 pc(s)	50 pc(s)



Height 20 mm, pre-assembled with screw, plastic base and plug

Part No.	207 109	207 107
Hole of conductor holder	Ø7.8 mm	Ø7.8 mm
Material of conductor holder	StSt	Cu
Conductor support Rd	8 mm	8 mm
Screw	⌀ 5 x 50 mm	⌀ 5 x 50 mm
Plastic plug	Ø8 x 40 mm	Ø8 x 40 mm
Standard	EN 62561-4	EN 62561-4
PU	50 pc(s)	50 pc(s)



Conductor Holders DEHNSnap

Plastic holder system with loose conductor routing.

Height 16 mm with female thread

Part No.	204 001	204 007	204 002	204 017
Thread of conductor holder	M6	M6	M8	M8
Material of conductor holder	plastic	plastic	plastic	plastic
Colour of conductor holder	grey ●	brown ●	grey ●	brown ●
Conductor support Rd	8 mm	8 mm	8 mm	8 mm
PU	100 pc(s)	50 pc(s)	50 pc(s)	100 pc(s)



Height 36 mm with female thread

Part No.	204 003	204 027	204 004	204 037
Thread of conductor holder	M6	M6	M8	M8
Material of conductor holder	plastic	plastic	plastic	plastic
Colour of conductor holder	grey ●	brown ●	grey ●	brown ●
Conductor support Rd	8 mm	8 mm	8 mm	8 mm
PU	100 pc(s)	100 pc(s)	50 pc(s)	50 pc(s)



Down Conductor – Conductor Holders

Height 16 mm with screw



Part No.	204 006
Thread of conductor holder	M8
Material of conductor holder	plastic
Colour of conductor holder	grey ●
Conductor support Rd	8 mm
Screw	⌀ 5 x 50 mm
PU	50 pc(s)

Height 16 mm, pre-assembled with screw, cover plate and dowel



Part No.	204 120
Thread of conductor holder	M8
Material of conductor holder	plastic
Colour of conductor holder	grey ●
Conductor support Rd	8 mm
Screw	⌀ 5 x 50 mm
Plastic plug	⌀8 x 40 mm
PU	50 pc(s)

Conductor Holders DEHNfix

Two-in-one system (fixes the holder and the conductor) with conductor holder DEHNquick, fixed conductor routing, UV-stabilised.



Height 30 mm

Part No.	250 000	250 001	250 007
Material of clamp	St/tZn	StSt	Cu
Material of base part	plastic	plastic	plastic
Conductor support Rd	6-10 mm	6-10 mm	6-10 mm
Colour of conductor holder	grey ●	grey ●	brown ●
Nail plug	⌀8 x 80 mm	⌀8 x 80 mm	⌀8 x 80 mm
Drilling depth	45 mm	45 mm	45 mm
PU	50 pc(s)	50 pc(s)	50 pc(s)

Note: Only suitable for solid stone or concrete.

Conductor Holders DEHNhold

Conductor holder with a slotted saddle clamp for fixing round conductors, fixed conductor routing. For use with different materials, e.g. Al, StSt, St/tZn and Cu.

With female thread

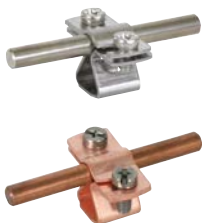

Part No.	274 110	274 117
Material of conductor holder	StSt	StSt / gal Cu
Conductor support Rd	8-10 mm	8-10 mm
Conductor support Fl	20 mm	20 mm
Height of conductor holder	20 mm	20 mm
Thread of conductor holder	M8	M8
Standard	EN 62561-4	EN 62561-4
PU	50 pc(s)	50 pc(s)

With female thread, pre-assembled with plastic base



Part No.	274 150
Material of conductor holder	StSt
Conductor support Rd	8-10 mm
Conductor support Fl	20 mm
Height of conductor holder	20 mm
Thread of conductor holder	M8
Standard	EN 62561-4
PU	50 pc(s)

Down Conductor – Conductor Holders

With female thread, pre-assembled with screw, plastic base and plug

Part No.	274 160	274 167
Material of conductor holder	StSt	StSt / gal Cu
Conductor support Rd	8-10 mm	8-10 mm
Conductor support Fl	20 mm	20 mm
Height of conductor holder	20 mm	20 mm
Thread of conductor holder	M8	M8
Plastic base	grey ●	brown ●
Screw	⌘ 5 x 50 mm	⌘ 5 x 50 mm
Standard	EN 62561-4	EN 62561-4
PU	50 pc(s)	50 pc(s)



With female thread, e.g. for round wire with plastic sheath

Part No.	274 113
Material of conductor holder	StSt
Conductor support Rd	13 mm
Height of conductor holder	20 mm
Thread of conductor holder	M8
PU	50 pc(s)



Conductor Holder with Saddle Clamp – Flat Design

Two-screw clamp with two M6 screws, for round and flat conductors.
With plastic cover disc (grey).

Pre-assembled with wood screw, plastic cover disc (grey) and plug

Part No.	286 819
Conductor support Rd	7-10 mm
Conductor support Fl	30 mm
Height of conductor holder	10 mm
Material of conductor holder	StSt
Screw	⌘ 5 x 50 mm
Plastic plug	∅8 x 40 mm
Standard	EN 62561-4
PU	50 pc(s)



Conductor Holders with Saddle Clamp and Flange

Complete unit with flange for installing conductors, fixed conductor routing.

With M8 female thread

Part No.	275 110
Conductor support Rd	7-10 mm
Thread of conductor holder	M8
Height of conductor holder	20 mm
Material of clamp	St/tZn
Material of base part	ZDC
Standard	EN 62561-4
PU	50 pc(s)



With female thread, pre-assembled with screw and plug

Part No.	275 160
Conductor support Rd	7-10 mm
Thread of conductor holder	M8
Height of conductor holder	20 mm
Material of clamp	St/tZn
Material of base part	ZDC
Screw	⌘ 5 x 50 mm
Plastic plug	∅8 x 40 mm
Standard	EN 62561-4
PU	50 pc(s)



With female thread, e.g. for round wire with plastic sheath



Part No.	275 113
Conductor support Rd	11-13 mm
Thread of conductor holder	M8
Height of conductor holder	20 mm
Material of clamp	St/tZn
Material of base part	ZDC
PU	50 pc(s)

Cover Discs and Plastic Bases

Intermediate element for screw-on / snap-on conductor and rod holders.

Plastic base

Snapped onto the conductor holders DEHNgrip and DEHNhold.



Part No.	276 016	276 017
Height	10 mm	10 mm
Diameter Ø	35 mm	35 mm
Material	plastic	plastic
Colour	grey ●	brown ●
Type	UV-stabilised	UV-stabilised
PU	100 pc(s)	100 pc(s)

Cover disc, plastic



Part No.	276 006	276 007
Height	5 mm	5 mm
Diameter Ø	37 mm	37 mm
Material	plastic	plastic
Colour	grey ●	brown ●
Type	UV-stabilised	UV-stabilised
PU	100 pc(s)	100 pc(s)

Cover disc, StSt



Part No.	276 009
Height	5 mm
Diameter Ø	37 mm
Material	StSt
PU	100 pc(s)

Conductor Holders with Saddle Clamp and Pin

Two-screw clamp with M6 screws, for round and flat conductors.



With square pin

Part No.	260 708	260 108	260 158	260 187
Conductor support Rd	7-10 mm	7-10 mm	7-10 mm	7-10 mm
Conductor support Fl	20 mm	20 mm	20 mm	20 mm
Material of saddle clamp	St/tZn	St/tZn	St/tZn	Cu
Material of base part	St/tZn	St/tZn	St/tZn	Cu
Fixing	square pin 70 mm	square pin 100 mm	square pin 150 mm	square pin 100 mm
PU	50 pc(s)	50 pc(s)	1 pc(s)	1 pc(s)

With loose round pin

Part No.	262 070	262 100
Conductor support Rd	7-10 mm	7-10 mm
Conductor support Fl	30 mm	30 mm
Material of saddle clamp	St/tZn	St/tZn
Material of base part	St/tZn	St/tZn
Fixing	round pin 70 mm	round pin 100 mm
PU	50 pc(s)	50 pc(s)

Conductor Holders for External Thermal Insulation Composite Systems

Two-screw clamp with M6 screws, fixed conductor routing.

Part No.	273 740	273 741	273 742
Clamping length	70 mm	100 mm	160 mm
Total length	140 mm	180 mm	230 mm
Conductor support Rd	7-10 mm	7-10 mm	7-10 mm
Material of base part	ZDC	ZDC	ZDC
Material of clamp	St/tZn	St/tZn	St/tZn
Height of conductor holder	20 mm	20 mm	20 mm
Screw, plug	TX40 7 x 140 mm	TX40 7 x 180 mm	TX40 7 x 240 mm
Standard	EN 62561-4	EN 62561-4	EN 62561-4
PU	50 pc(s)	50 pc(s)	1 pc(s)



Conductor Holder with Claw

Conductor holder for wall mounting with M6 clamping screw. Fixed conductor routing.

Part No.	273 019
Hole Ø	6.5 mm
Material of conductor holder	StSt
Conductor support Rd	6-10 mm
Height of conductor holder	22 mm
Standard	EN 62561-4
PU	50 pc(s)



Flush-mounted Conductor Holders/Saddle Clamps

Suitable for flush mounting.

DEHNQUICK with nail plug

Part No.	390 120	390 121	390 122
Material of conductor holder	StSt	St/tZn	StSt
Conductor support Rd	6-10 mm	6-10 mm	6-10 mm
Nail plug	Ø6 x 60 mm	Ø8 x 80 mm	Ø8 x 80 mm
PU	50 pc(s)	50 pc(s)	50 pc(s)



DEHNQUICK

Single-screw clamp piece with flexible clamping range and fixed conductor routing.

Part No.	202 000	202 001	202 169
Material of conductor holder	St/tZn	StSt	StSt
Conductor support Rd	6-10 mm	6-10 mm	6-10 mm
Hole Ø	8.5 mm	8.5 mm	6.5 mm
PU	50 pc(s)	50 pc(s)	100 pc(s)



Clamping piece

Single-screw clamp piece with flexible clamping range and fixed conductor routing.

Part No.	390 110	390 119
Material of conductor holder	St/tZn	StSt
Conductor support Rd	6-10 mm	6-10 mm
Hole Ø	9 mm	9 mm
PU	100 pc(s)	100 pc(s)



Flush-mounted Conductor Holder

With clamping plate for nailing.

Part No.	260 118
Conductor support Rd	6-10 mm
Material of conductor holder	St/tZn
Conductor routing	fixed / loose
Fixing	square pin 70 mm
PU	50 pc(s)



Conductor Holders for Downpipes



For installing down conductors on downpipes with fixed conductor routing. All types are also suitable for plastic downpipes.

Type PPS With worm gear.

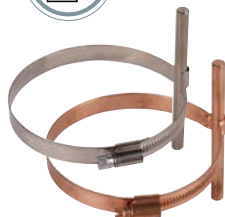

Part No.	200 079	200 077	200 089	200 087
Clamping range Ø pipe	80-100 mm	80-100 mm	100-120 mm	100-120 mm
Conductor support Rd	8 mm	8 mm	8 mm	8 mm
Material of conductor holder	StSt	StSt / gal Cu	StSt	StSt / gal Cu
PU	50 pc(s)	50 pc(s)	50 pc(s)	50 pc(s)

Type PS Screwless, pre-punched for tongs.



Part No.	200 069	200 067	200 059	200 057
Clamping range Ø pipe	80-120 mm, in steps of 5 mm	80-120 mm, in steps of 5 mm	100 mm	100 mm
Conductor support Rd	8 mm	8 mm	8 mm	8 mm
Material of conductor holder	StSt	Cu	StSt	Cu
PU	25 pc(s)	25 pc(s)	25 pc(s)	25 pc(s)

Type PV Adjustable, with clamping screw M8.



Part No.	200 029	200 039	200 027
Clamping range Ø pipe	50-120 mm	50-150 mm	50 -120 mm
Conductor support Rd	6-8 mm	6-8 mm	6-8 mm
Material of conductor holder	StSt	StSt	Cu/bronze
PU	10 pc(s)	10 pc(s)	10 pc(s)

Downpipe Clamps

Pipe clamps for connecting downpipes to the lightning equipotential bonding according to IEC/EN 62305-3. Connection possibilities for Rd, e.g. with KS connector (Part No. 301 000) or with clamping piece (Part No. 390 150) (according to material).

For fixed pipe diameters



Part No.	420 100	420 120	420 107	420 127
Material	St/tZn	St/tZn	Cu	Cu
Clamping range pipe Ø	100 mm	120 mm	100 mm	120 mm
Hole Ø	11 mm	11 mm	11 mm	11 mm
Standard	EN 62561-1	EN 62561-1	EN 62561-1	EN 62561-1
PU	50 pc(s)	1 pc(s)	1 pc(s)	1 pc(s)

Bimetallic type

For connecting St conductors with Cu downpipes, with St/tZn clamping piece and intermediate plate (Cupal).

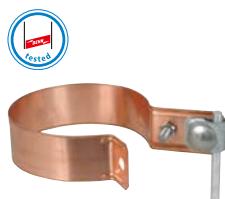

Part No.	420 207
Material	Cu / St/tZn
Clamping range pipe Ø	100 mm
Clamping range Rd	6-10 mm
Standard	EN 62561-1
PU	1 pc(s)

Type RV, adjustable

With additional anti-rotation locking of the fixing screw and markings, predetermined bending points as well as pre-punched cutting aids.

General technical data:	
Hole Ø	10.5 mm
Standard	EN 62561-1



Part No.	423 010	423 011	423 017	423 019
Material	St/tZn	Al	Cu	StSt
Clamping range pipe Ø	60-100 mm	60-100 mm	60-100 mm	60-100 mm
Length	337 mm	337 mm	337 mm	337 mm
PU	50 pc(s)	50 pc(s)	1 pc(s)	50 pc(s)



Part No.	423 020	423 021	423 027	423 029
Material	St/tZn	Al	Cu	StSt
Clamping range pipe Ø	60-150 mm	60-150 mm	60-150 mm	60-150 mm
Length	494 mm	494 mm	494 mm	494 mm
PU	50 pc(s)	50 pc(s)	50 pc(s)	50 pc(s)

Clamping Piece Variants

For example as a connection with end piece for constructions or downpipe clamps.
Clamping piece with square hole 11 mm and truss head screw.

Part No.	390 150	390 157	390 159
Material of clamp	St/tZn	Cu	StSt
Clamping range Rd	6-10 mm	6-10 mm	6-10 mm
Screw	⬆ M10 x 35 mm	⬆ M10 x 35 mm	⬆ M10 x 35 mm
Material of screw / nut	St/tZn	StSt	StSt
Standard	EN 62561-1	EN 62561-1	EN 62561-1
PU	100 pc(s)	1 pc(s)	100 pc(s)



KS Connectors

Clamping screw connector (KlemmSchrauben-Verbinder) for lightning current carrying connection of round conductors, e.g. to flat profiles, downpipe clamps or other parts of the lightning protection system.

One-piece, St/tZn With screw and nut M10.

Part No.	301 000	301 010
Material of clamping screw	St/tZn	St/tZn
Material of clamp	ZDC	ZDC
Clamping range Rd	7-10 mm	7-10 mm
Type	—	+ spring washer
Standard	EN 62561-1	EN 62561-1
PU	100 pc(s)	100 pc(s)

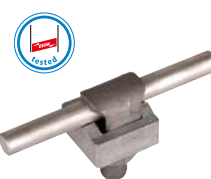

One-piece, Cu With screw and nut M10.

Part No.	301 007	301 017
Material of clamping screw	Cu	Cu
Material of clamp	Gunmetal	Gunmetal
Clamping range Rd	6-10 mm	6-10 mm
Connection (single-wire / multi-wire)	25-70 mm ²	25-70 mm ²
Type	—	+ spring washer
Standard	EN 62561-1	EN 62561-1
PU	1 pc(s)	1 pc(s)

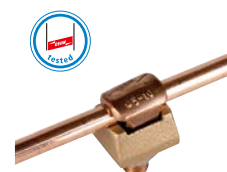

One-piece, StSt With screw and nut M10.

General technical data:	
Clamping range Rd	6-10 mm
Standard	EN 62561-1

Part No.	301 009	301 089	301 019
Material of clamping screw	StSt	StSt (V4A)	StSt
Material of clamp	StSt	StSt (V4A)	StSt
Connection (single-wire / multi-wire)	25-70 mm ²	25-70 mm ²	25-70 mm ²
Type	—	—	+ spring washer
PU	100 pc(s)	100 pc(s)	100 pc(s)



Part No.	301 099	540 122
Material of clamping screw	StSt (V4A)	StSt (V4A)
Material of clamp	StSt (V4A)	StSt (V4A)
Connection (single-wire / multi-wire)	25-70 mm ²	16-50 mm ²
Type	+ spring washer	+ spring washer
PU	100 pc(s)	25 pc(s)



Heavy design With screw and nut M12.

Part No.	300 002	300 017
Material of clamping screw	St/tZn	Cu
Material of clamp	MCI	Gunmetal
Clamping range Rd	8-12.5 mm	8-12.5 mm
Connection (single-wire / multi-wire)	50-95 mm ²	50-95 mm ²
Standard	EN 62561-1	EN 62561-1
PU	25 pc(s)	1 pc(s)

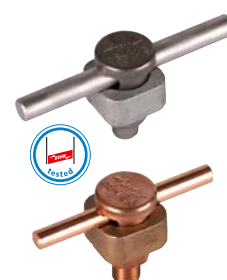

Down Conductor – Conductor Holders



Two-piece, gap 30 mm With screw and nut M10.

Part No.	302 010
Material of clamping screw	St/tZn
Material of clamp	ZDC
Clamping range Rd	7-10 mm
Standard	EN 62561-1
PU	50 pc(s)



Two-piece, gap 40 mm With screw and nut M10.

Part No.	301 229
Material of clamping screw	StSt
Material of clamp	StSt
Clamping range Rd	6-10 mm
Type	+ spring washer
Standard	EN 62561-1
PU	1 pc(s)

Plastic Conductor Holders for Downpipes

For separately fixing earth entries on metal downpipes.
Holder with clamping part for fixing the tensioning strap (dimensions 14 x 0.3 mm).

For round conductors

Fixed conductor routing, made of weather-resistant plastic, UV-stabilised and halogen-free.



Part No.	275 711
Material of conductor holder	PA
Material of clamping part	StSt
Conductor support Rd	6-11 mm
PU	50 pc(s)

For flat strips or round conductors

Fixed conductor routing, made of weather-resistant plastic, UV-stabilised and halogen-free.



Part No.	275 730
Material of conductor holder	PA
Material of clamping part	StSt
Conductor support Rd	6-11 mm
Conductor support Fl	30 mm
PU	50 pc(s)

For earth entry rods

Fixed conductor routing, made of weather-resistant plastic, UV-stabilised and halogen-free.



Part No.	275 716
Material of conductor holder	PA
Material of clamping part	StSt
Conductor support Rd	16 mm
PU	50 pc(s)

Separate clamping head

For combination with endless tensioning strap (Part No. 540 931 or Part No. 540 905).



Part No.	540 930
Material of grip head / strap	StSt
Screw	🔩 (wrench size 13) M8 x 16 mm
PU	25 pc(s)

Endless tensioning strap

Cut to length with sheet metal shears.



Part No.	540 931	540 905
Material of grip head / strap	StSt	StSt
Dimensions of strap (w x d)	14 x 0.3 mm	14 x 0.3 mm
Packing	plastic	cardboard
Length	50 m	100 m
PU	1 pc(s)	1 pc(s)

Staples

Staples for fixing conductors on objects like wooden masts.

Part No.	538 010
Material of conductor holder	St/tZn
Conductor support Rd	6-10 mm
Conductor routing	fixed / loose
PU	500 pc(s)



Flat Strip Holders DEHNhold

For fixing flat conductors via a slotted clamp, fixed conductor routing.
For use with different materials, e.g. Al, StSt, St/tZn and Cu.

With female thread

Part No.	274 030
Material of conductor holder	StSt
Conductor support Fl	30 x 3.5 mm
Conductor support Rd	6-10 mm
Height of conductor holder	20 mm
Thread of conductor holder	M8
Standard	EN 62561-4
PU	50 pc(s)



Pre-assembled with screw, plastic base and plug

Part No.	274 230
Material of conductor holder	StSt
Conductor support Fl	30 x 3.5 mm
Conductor support Rd	6-10 mm
Height of conductor holder	20 mm
Thread of conductor holder	M8
Screw	⌀ 5 x 50 mm
Plastic plug	Ø8 x 40 mm
Standard	EN 62561-4
PU	50 pc(s)



Flat Strip Holders with Clamping Plate – Flat Design

Two-screw clamp with M6 screws.

With slot (6.5 x 16 mm)

Part No.	284 030	284 040
Height of conductor holder	10 mm	10 mm
Conductor support Fl	30 x 3.5 mm	40 x 4-5 mm
Material of conductor holder	St/tZn	St/tZn
Material of base part	St/tZn	St/tZn
Width of component	58 mm	70 mm
Standard	EN 62561-4	EN 62561-4
PU	100 pc(s)	100 pc(s)



With slot (6.5 x 16 mm) and pre-assembled wood screw

Part No.	286 030	286 139
Height of conductor holder	10 mm	8.5 mm
Conductor support Fl	30 x 3.5 mm	30 x 3.5 mm
Material of conductor holder	St/tZn	StSt
Material of base part	St/tZn	StSt
Screw	⌀ 5 x 50 mm	⌀ 5 x 50 mm
Width of component	58 mm	58 mm
Standard	EN 62561-4	EN 62561-4
PU	50 pc(s)	50 pc(s)



Flat Strip Holders with Clamping Plate and Flange

Complete unit with flange for installing flat strips.

With female thread



Part No.	275 030
Conductor support Fl	30 x 3.5 mm
Thread of conductor holder	M8
Height of conductor holder	20 mm
Material of clamping plate	St/tZn
Material of base part	ZDC
Standard	EN 62561-4
PU	50 pc(s)

With female thread, pre-assembled with screw and plug



Part No.	275 230
Conductor support Fl	30 x 3.5 mm
Thread of conductor holder	M8
Height of conductor holder	20 mm
Material of clamping plate	St/tZn
Material of base part	ZDC
Screw	⌀5 x 50 mm
Plastic plug	Ø8 x 40 mm
Standard	EN 62561-4
PU	50 pc(s)

Flat Strip / Round Conductor Holders with Thrust Piece

For wall mounting.

Thrust piece with M8 screw for installing flat strips up to 11 mm and round conductors 6-10 mm.



Distance from wall 11 mm

Part No.	277 230	277 237	277 239
Material of conductor holder	St/tZn	Cu	StSt
Fixing	Ø13 and 7 x 20 mm	Ø13 and 7 x 20 mm	Ø13 and 7 x 20 mm
Slot width	12 mm	12 mm	12 mm
Material of screw	StSt	StSt	StSt
Standard	EN 62561-4	EN 62561-4	EN 62561-4
PU	25 pc(s)	25 pc(s)	25 pc(s)

Distance from wall 15 mm



Part No.	277 240
Material of conductor holder	St/tZn
Fixing	7 x 15 mm
Slot width	12 mm
Material of screw	StSt
Standard	EN 62561-4
PU	25 pc(s)

Staples for Flat Strips

For fixing strips on objects like wooden masts.

Part No.	538 030
Material of conductor holder	St/tZn
Conductor support Fl	30 mm
Conductor routing	fixed / loose
PU	300 pc(s)



Anchors for Rigid Foam Boards

For fixing conductor, flat strip and rod holders in external thermal insulation composite systems.
With star drive (TX40).
Mounting with wood screws $\varnothing 4.5$ mm.



This anchor may only be used for fixing conductor holders if there is no additional traction on the down conductor.

Short design

Part No.	200 600
Material	PA
Thickness of insulating material	60 mm
Anchoring depth / length	50 mm
PU	50 pc(s)



Long design

Part No.	200 601
Material	PA
Thickness of insulating material	100 mm
Anchoring depth / length	85 mm
PU	50 pc(s)



Wood Screws with Threaded Head

Hanger bolt for fixing conductor, flat strip and rod holders with female thread.

Part No.	528 850	528 870
Material	St/gal Zn	St/gal Zn
Thread	M8	M8
Total length	53 mm	73 mm
Thread length	32 mm	42 mm
PU	1 pc(s)	1 pc(s)



Lightning Strike Counter

Counter for digitally recording impulse currents. The discharge current counter is preferably installed between the equipotential bonding bar and the earth-termination system.



Part No.	599 100
Operating current (8/20 μ s) (I_{IC})	1 kA
Max. discharge current (10/350 μ s) (I_{MCW})	100 kA
Clamping range Rd	8-10 mm
Clamping range Fl	max. 30 mm
Degree of protection	IP 65
PU	1 pc(s)



Protection against step and touch voltage see from page 216

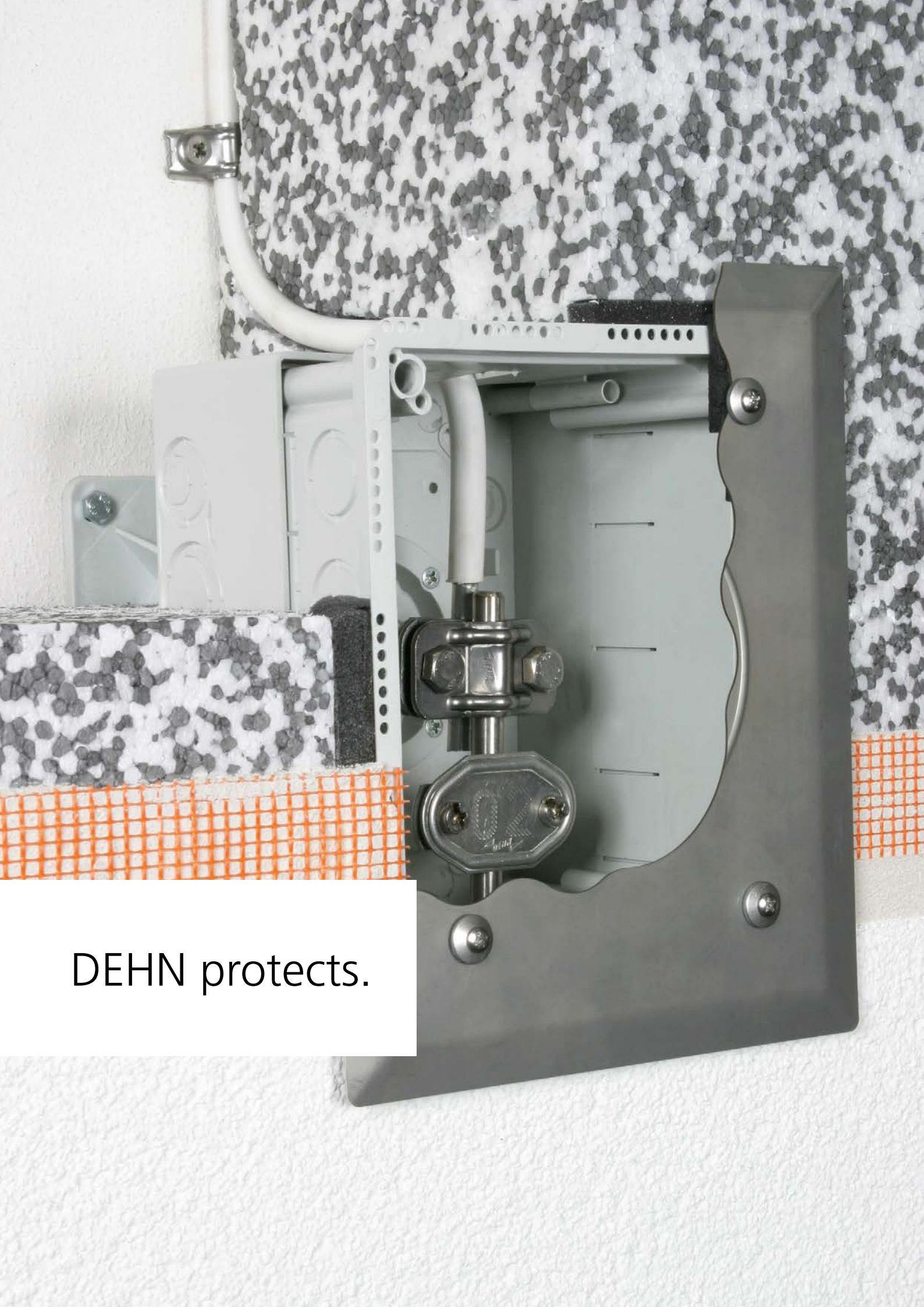

DEHN protects.

Earth Entry Rod Set

Complete with disconnecting sleeve and connection clamps (KS screws).

Type St/tZn

With disconnecting sleeve (Part No. 450 000) and KS screws (Part No. 300 000).

Part No.	480 150
Material	St/tZn
Standard	EN 62561-(1+2)
Length	1500 mm
Connection KS screw Rd	7-10 mm
Connection sleeve Rd / Rd	7-10 / 16 mm
PU	1 pc(s)



Type Cu

With disconnecting sleeve (Part No. 450 007) and KS screws (Part No. 300 007).

Part No.	480 157
Material	Cu
Standard	EN 62561-(1+2)
Length	1500 mm
Connection KS screw Rd	6-10 mm
Connection sleeve Rd / Rd	7-10 / 16 mm
PU	1 pc(s)

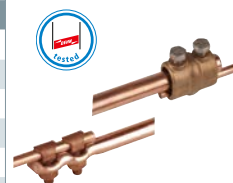

Earth Entry Rods

For connecting down conductors to the earth-termination system.

Chamfered

General technical data:			
Standard	EN 62561-2		
Diameter Ø	16 mm		
Part No.	483 150	483 200	104 903
Material	St/tZn	St/tZn	StSt (V4A)
Material No.	—	—	1.4571 / 1.4404 / 1.4401
ASTM / AISI:	—	—	316Ti / 316L / 316
Length	1500 mm	2000 mm	1000 mm
PU	10 pc(s)	10 pc(s)	10 pc(s)
Part No.	104 905	104 906	
Material	StSt (V4A)	StSt (V4A)	
Material No.	1.4571 / 1.4404 / 1.4401	1.4571 / 1.4404 / 1.4401	
ASTM / AISI:	316Ti / 316L / 316	316Ti / 316L / 316	
Length	1500 mm	2000 mm	
PU	10 pc(s)	10 pc(s)	



With forged flat lug

Hole Ø11 mm, hole distance 22 mm.

Part No.	101 150
Material	St/tZn
Standard	EN 62561-2
Diameter Ø	16 mm
Length	1500 mm
Hole distance	22 mm
PU	10 pc(s)



Tapered

Notched conductor Ø10 mm, partly insulated (length approx. 700 mm).

Part No.	480 018	480 019	480 020	480 021
Material	St/tZn	St/tZn	St/tZn	St/tZn
Standard	EN 62561-2	EN 62561-2	EN 62561-2	EN 62561-2
Diameter Ø	16 / 10 mm	16 / 10 mm	16 / 10 mm	16 / 10 mm
Total length	1500 mm	1750 mm	2000 mm	2500 mm
Partial length Ø16 mm	1000 mm	750 mm	1000 mm	1500 mm
Partial length Ø10 mm	500 mm	1000 mm	1000 mm	1000 mm
PU	10 pc(s)	10 pc(s)	10 pc(s)	10 pc(s)



Straightened / Angled Connection Lugs

For connecting down conductors to the earth-termination system; made of corrosion-resistant stainless steel.

Round wires



Part No.	860 110	860 115	860 130
Material	StSt (V4A)	StSt (V4A)	StSt (V4A)
Material No.	1.4571 / 1.4404	1.4571 / 1.4404	1.4571 / 1.4404
ASTM / AISI:	316Ti / 316L	316Ti / 316L	316Ti / 316L
Length	1000 mm	1500 mm	3000 mm
Dimensions	Ø10 mm	Ø10 mm	Ø10 mm
Cross-section	78 mm ²	78 mm ²	78 mm ²
Standard	EN 62561-2	EN 62561-2	EN 62561-2
PU	5 pc(s)	5 pc(s)	5 pc(s)

Flat strips



Part No.	860 210	860 215	860 230
Material	StSt (V4A)	StSt (V4A)	StSt (V4A)
Material No.	1.4571 / 1.4404	1.4571 / 1.4404	1.4571 / 1.4404
ASTM / AISI:	316Ti / 316L	316Ti / 316L	316Ti / 316L
Length	1000 mm	1500 mm	3000 mm
Dimensions	30 x 3.5 mm	30 x 3.5 mm	30 x 3.5 mm
Cross-section	105 mm ²	105 mm ²	105 mm ²
Standard	EN 62561-2	EN 62561-2	EN 62561-2
PU	5 pc(s)	5 pc(s)	5 pc(s)

Flat strips with holes

Holes at intervals of 500 mm.



Part No.	860 425	860 430
Material	StSt	StSt (V4A)
Material No.	1.4301	1.4571 / 1.4404
ASTM / AISI:	—	316Ti / 316L
Length	3000 mm	3000 mm
Dimensions	30 x 3.5 mm	30 x 3.5 mm
Fixing	[6x] 6.5 x 12 mm	[6x] 6.5 x 12 mm
Hole distance	500 mm	500 mm
Cross-section	105 mm ²	105 mm ²
Standard	EN 62561-2	EN 62561-2
PU	5 pc(s)	5 pc(s)

Flat strips, angled

For wall mounting (without a gap) with holes for countersunk head screws.



Part No.	860 315	860 330
Material	StSt (V4A)	StSt (V4A)
Material No.	1.4571 / 1.4404	1.4571 / 1.4404
ASTM / AISI:	316Ti / 316L	316Ti / 316L
Length	1500 mm	3000 mm
Dimensions	30 x 3.5 mm	30 x 3.5 mm
Connection	disconnecting clamp or KS connector	disconnecting clamp or KS connector
Fixing	[3x] Ø6.5 mm	[6x] Ø6.5 mm
Hole distance	500 mm	500 mm
Cross-section	105 mm ²	105 mm ²
Standard	EN 62561-2	EN 62561-2
PU	5 pc(s)	5 pc(s)

Other dimensions are available upon request.

Marker for Connection Lugs

Attached to round wires or strips to make them conspicuous (as required by DIN 18014) during the construction work.

Part No.	478 099
Material	PVC
Diameter Ø	70 mm
Fits on FI	30 x 3.5 mm
Fits on Rd	10 mm
Colour	green ● / yellow ●
PU	20 pc(s)



Conductor Holders DEHNhold

Conductor holder with a slotted saddle clamp for fixing round conductors, fixed conductor routing. For use with different materials, e.g. Al, StSt, St/tZn and Cu.

With female thread

Part No.	274 110	274 117
Material of conductor holder	StSt	StSt / gal Cu
Conductor support Rd	8-10 mm	8-10 mm
Conductor support FI	20 mm	20 mm
Height of conductor holder	20 mm	20 mm
Thread of conductor holder	M8	M8
Standard	EN 62561-4	EN 62561-4
PU	50 pc(s)	50 pc(s)

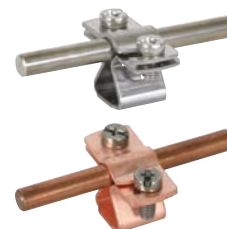

With female thread, pre-assembled with plastic base

Part No.	274 150
Material of conductor holder	StSt
Conductor support Rd	8-10 mm
Conductor support FI	20 mm
Height of conductor holder	20 mm
Thread of conductor holder	M8
Standard	EN 62561-4
PU	50 pc(s)



With female thread, pre-assembled with screw, plastic base and plug

Part No.	274 160	274 167
Material of conductor holder	StSt	StSt / gal Cu
Conductor support Rd	8-10 mm	8-10 mm
Conductor support FI	20 mm	20 mm
Height of conductor holder	20 mm	20 mm
Thread of conductor holder	M8	M8
Plastic base	grey ●	brown ●
Screw	⌘ 5 x 50 mm	⌘ 5 x 50 mm
Standard	EN 62561-4	EN 62561-4
PU	50 pc(s)	50 pc(s)



With female thread, e.g. for round wire with plastic sheath

Part No.	274 113
Material of conductor holder	StSt
Conductor support Rd	13 mm
Height of conductor holder	20 mm
Thread of conductor holder	M8
PU	50 pc(s)



Conductor Holder with Saddle Clamp – Flat Design

Two-screw clamp with two M6 screws, for round and flat conductors.
With plastic cover disc (grey).

Pre-assembled with wood screw, plastic cover disc (grey) and plug



Part No.	286 819
Conductor support Rd	7-10 mm
Conductor support Fl	30 mm
Height of conductor holder	10 mm
Material of conductor holder	StSt
Screw	5 x 50 mm
Plastic plug	Ø8 x 40 mm
Standard	EN 62561-4
PU	50 pc(s)

Conductor Holders with Saddle Clamp and Flange

Complete unit with flange for installing conductors, fixed conductor routing.

With M8 female thread



Part No.	275 110
Conductor support Rd	7-10 mm
Thread of conductor holder	M8
Height of conductor holder	20 mm
Material of clamp	St/tZn
Material of base part	ZDC
Standard	EN 62561-4
PU	50 pc(s)

With female thread, pre-assembled with screw and plug



Part No.	275 160
Conductor support Rd	7-10 mm
Thread of conductor holder	M8
Height of conductor holder	20 mm
Material of clamp	St/tZn
Material of base part	ZDC
Screw	5 x 50 mm
Plastic plug	Ø8 x 40 mm
Standard	EN 62561-4
PU	50 pc(s)

With female thread, e.g. for round wire with plastic sheath



Part No.	275 113
Conductor support Rd	11-13 mm
Thread of conductor holder	M8
Height of conductor holder	20 mm
Material of clamp	St/tZn
Material of base part	ZDC
PU	50 pc(s)

Conductor Holders for External Thermal Insulation Composite Systems

Two-screw clamp with M6 screws, fixed conductor routing.

Part No.	273 740	273 741	273 742
Clamping length	70 mm	100 mm	160 mm
Total length	140 mm	180 mm	230 mm
Conductor support Rd	7-10 mm	7-10 mm	7-10 mm
Material of base part	ZDC	ZDC	ZDC
Material of clamp	St/tZn	St/tZn	St/tZn
Height of conductor holder	20 mm	20 mm	20 mm
Screw, plug	⌀ (TX40) 7 x 140 mm	⌀ (TX40) 7 x 180 mm	⌀ (TX40) 7 x 240 mm
Standard	EN 62561-4	EN 62561-4	EN 62561-4
PU	50 pc(s)	50 pc(s)	1 pc(s)



Rod Holders DEHNhold

For fixing air-termination and earth entry rods, with slotted saddle clamp, fixed conductor routing.
For use with different materials, e.g. Al, StSt, St/tZn and Cu.

With female thread

Part No.	274 116
Material of conductor holder	StSt
Conductor support Rd	16 mm
Height of conductor holder	20 mm
Thread of conductor holder	M8
PU	50 pc(s)



Pre-assembled with screw, plastic base and plug

With female thread.

Part No.	274 260
Material of conductor holder	StSt
Conductor support Rd	16 mm
Height of conductor holder	20 mm
Thread of conductor holder	M8
Screw	⌀ 5 x 50 mm
Plastic dowel	⌀8 x 40 mm
PU	50 pc(s)



Rod Holders with Saddle Clamp and Flange

Complete unit with flange for installing air-termination and earth entry rods, fixed conductor routing.

With female thread



Part No.	275 116
Conductor support Rd	16 mm
Thread of conductor holder	M8
Height of conductor holder	20 mm
Material of saddle clamp	St/tZn
Material of base part	ZDC
PU	50 pc(s)

Pre-assembled with screw and plug



Part No.	275 260
Conductor support Rd	16 mm
Thread of conductor holder	M8
Height of conductor holder	20 mm
Material of saddle clamp	St/tZn
Material of base part	ZDC
Screw	⌀5 x 50 mm
Plastic plug	Ø8 x 40 mm
PU	50 pc(s)

Rod Holders with Clamp and Pin

Two-screw clamp with M6 screws for air-termination and earth entry rods, fixed conductor routing.



With square pin

Part No.	260 106
Material of saddle clamp	St/tZn
Material of base part	St/tZn
Conductor support Rd	16 mm
Fixing	square pin 100 mm
PU	50 pc(s)

Rod Holders for External Thermal Insulation Composite Systems

Two-screw clamp with M6 screws, with flange (ZDC) and plastic plug Ø10 mm.



Part No.	273 731
Thickness of insulating material	approx. 110 mm
Drilling depth	approx. 190 mm
Material of saddle clamp	St/tZn
Material of base part	ZDC
Height of conductor holder	20 mm
Conductor support Rd	16 mm
Screw / plug	⌀7 (TX40) 7 x 180 mm
PU	1 pc(s)

Rod Holders DEHNfix

Two-in-one holder system (fixes the holder and the conductor), fixed conductor routing.
Only suitable for solid stone or concrete.

Part No.	252 000
Material of saddle clamp	St/tZn
Material of base part	plastic
Colour of conductor holder	grey ●
Installation height of base part	42 mm
Conductor support Rd	16 mm
Nail plug	100 / 60 mm
Hole Ø for nail plug	10 mm
Drilling depth	60 mm
PU	50 pc(s)



Rod Holder with Claw

For wall mounting with fixing screw M6, fixed conductor routing.

Part No.	275 019
Hole Ø	6.5 mm
Material of conductor holder	StSt
Height of conductor holder	28 mm
Conductor support Rd	13-16 mm
PU	50 pc(s)



Flat Strip Holders DEHNhold

For fixing flat conductors via a slotted clamp, fixed conductor routing.
For use with different materials, e.g. Al, StSt, St/tZn and Cu.

With female thread

Part No.	274 030
Material of conductor holder	StSt
Conductor support Fl	30 x 3.5 mm
Conductor support Rd	6-10 mm
Height of conductor holder	20 mm
Thread of conductor holder	M8
Standard	EN 62561-4
PU	50 pc(s)



Pre-assembled with screw, plastic base and plug

Part No.	274 230
Material of conductor holder	StSt
Conductor support Fl	30 x 3.5 mm
Conductor support Rd	6-10 mm
Height of conductor holder	20 mm
Thread of conductor holder	M8
Screw	⚡ 5 x 50 mm
Plastic plug	Ø8 x 40 mm
Standard	EN 62561-4
PU	50 pc(s)



Flat Strip Holders with Clamping Plate – Flat Design

Two-screw clamp with M6 screws.

With slot (6.5 x 16 mm)



Part No.	284 030	284 040
Height of conductor holder	10 mm	10 mm
Conductor support Fl	30 x 3.5 mm	40 x 4-5 mm
Material of conductor holder	St/tZn	St/tZn
Material of base part	St/tZn	St/tZn
Width of component	58 mm	70 mm
Standard	EN 62561-4	EN 62561-4
PU	100 pc(s)	100 pc(s)

With slot (6.5 x 16 mm) and pre-assembled wood screw



Part No.	286 030	286 139
Height of conductor holder	10 mm	8.5 mm
Conductor support Fl	30 x 3.5 mm	30 x 3.5 mm
Material of conductor holder	St/tZn	StSt
Material of base part	St/tZn	StSt
Screw	⌀ 5 x 50 mm	⌀ 5 x 50 mm
Width of component	58 mm	58 mm
Standard	EN 62561-4	EN 62561-4
PU	50 pc(s)	50 pc(s)

Flat Strip Holders with Clamping Plate and Flange

Complete unit with flange for installing flat strips.

With female thread



Part No.	275 030
Conductor support Fl	30 x 3.5 mm
Thread of conductor holder	M8
Height of conductor holder	20 mm
Material of clamping plate	St/tZn
Material of base part	ZDC
Standard	EN 62561-4
PU	50 pc(s)

With female thread, pre-assembled with screw and plug



Part No.	275 230
Conductor support Fl	30 x 3.5 mm
Thread of conductor holder	M8
Height of conductor holder	20 mm
Material of clamping plate	St/tZn
Material of base part	ZDC
Screw	⌀ 5 x 50 mm
Plastic plug	Ø8 x 40 mm
Standard	EN 62561-4
PU	50 pc(s)

Flat Strip / Round Conductor Holders with Thrust Piece

For wall mounting.

Thrust piece with M8 screw for installing flat strips up to 11 mm and round conductors 6-10 mm.

Distance from wall 11 mm



Part No.	277 230	277 237	277 239
Material of conductor holder	St/tZn	Cu	StSt
Fixing	Ø13 and 7 x 20 mm	Ø13 and 7 x 20 mm	Ø13 and 7 x 20 mm
Slot width	12 mm	12 mm	12 mm
Material of screw	StSt	StSt	StSt
Standard	EN 62561-4	EN 62561-4	EN 62561-4
PU	25 pc(s)	25 pc(s)	25 pc(s)

Connection Lugs, Conductor Holders, Test Joint Boxes

Distance from wall 15 mm

Part No.	277 240
Material of conductor holder	St/tZn
Fixing	7 x 15 mm
Slot width	12 mm
Material of screw	StSt
Standard	EN 62561-4
PU	25 pc(s)



Staples

Staples for fixing conductors on objects like wooden masts.

Part No.	538 010
Material of conductor holder	St/tZn
Conductor support Rd	6-10 mm
Conductor routing	fixed / loose
PU	500 pc(s)



Staples for Flat Strips

For fixing strips on objects like wooden masts.

Part No.	538 030
Material of conductor holder	St/tZn
Conductor support Fl	30 mm
Conductor routing	fixed / loose
PU	300 pc(s)



Anchors for Rigid Foam Boards

For fixing conductor, flat strip and rod holders in external thermal insulation composite systems.
With star drive (TX40).
Mounting with wood screws Ø4.5 mm.



This anchor may only be used for fixing conductor holders if there is no additional traction on the down conductor.

Short design

Part No.	200 600
Material	PA
Thickness of insulating material	60 mm
Anchoring depth / length	50 mm
PU	50 pc(s)



Long design

Part No.	200 601
Material	PA
Thickness of insulating material	100 mm
Anchoring depth / length	85 mm
PU	50 pc(s)



Wood Screws with Threaded Head

Hanger bolt for fixing conductor, flat strip and rod holders with female thread.

Part No.	528 850	528 870
Material	St/gal Zn	St/gal Zn
Thread	M8	M8
Total length	53 mm	73 mm
Thread length	32 mm	42 mm
PU	1 pc(s)	1 pc(s)



FIX Test Joint

With insulating piece and disconnection lug.

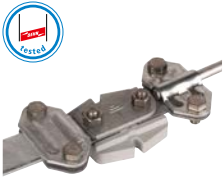

Part No.	453 100
Material	St/tZn
Clamping range Rd / FI	8-10 / 30-40 mm
Insulating piece	plastic grey ●
Standard	EN 62561-1
PU	10 pc(s)

A version for conductor Rd / Rd 8-10 mm (Part No. 453 102) is available upon request.

UF Test Joint Boxes



For underground installation, for disconnecting the down conductor from the earth-termination system for measuring purposes.

Type GCI – with integrated, easily accessible test joint

Detachable with a key, including terminal for the down conductor and the earthing conductor, open (without bottom).



Part No.	549 001
Material	GCI
Colour	black (varnished) ●
Dimensions	300 x 220 x 120 mm
Clamping range Rd / FI	7-10 / 30-40 mm
Standard	EN 62561-5
Max. permissible load	40 kN
PU	1 pc(s)

Type GCI – without test joint

Open (without bottom).



Part No.	549 000
Material	GCI
Colour	black (varnished) ●
Dimensions	300 x 220 x 120 mm
Standard	EN 62561-5
Max. permissible load	40 kN
PU	1 pc(s)

Type plastic – with integrated, easily accessible test joint

Detachable with a key, including terminal for the down conductor and the earthing conductor, open (without bottom).



Part No.	549 050
Material	plastic
Colour	grey ●
Dimensions	197 x 197 x 204 mm
Clamping range Rd / FI	7-10 / 30-40 mm
Standard	EN 62561-5
Max. permissible load	15 kN
PU	1 pc(s)

Type plastic – without test joint

Open (without bottom).



Part No.	549 051
Material	plastic
Colour	grey ●
Dimensions	197 x 197 x 204 mm
Standard	EN 62561-5
Max. permissible load	15 kN
PU	1 pc(s)

Type StSt – with integrated, easily accessible test joint

Detachable with a key, including terminal for the down conductor and the earthing conductor, open (without bottom).

Part No.	549 090
Material	StSt
Dimensions	200 x 200 x 105 mm
Clamping range Rd / Fl	7-10 / 30-40 mm
Standard	EN 62561-5
Max. permissible load	40 kN
PU	1 pc(s)



Type StSt – without test joint

Open (without bottom).

Part No.	549 091
Material	StSt
Dimensions	200 x 200 x 105 mm
Standard	EN 62561-5
Max. permissible load	40 kN
PU	1 pc(s)



Test Joint Boxes

For concrete construction with integrated test joint and special construction markings.



With rigid connection lugs

Rd 8 and Rd 10 mm, approx. 200 mm long (insulated).

Part No.	476 010
Material of box	plastic
Dimensions of box	140 x 140 x 68 mm
Material of cover	StSt
Dimensions of cover	160 x 160 mm
Standard	EN 62561-1
PU	1 pc(s)

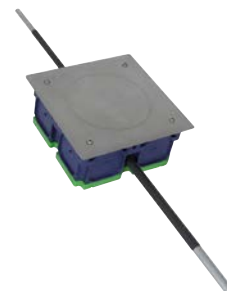

With flexible connection cables

Made of Cu (16 mm²), Cu/gal Sn cable lug (hole 10.5 mm).

Part No.	476 016
Material of box	plastic
Dimensions of box	140 x 140 x 68 mm
Material of cover	StSt
Dimensions of cover	160 x 160 mm
Standard	EN 62561
PU	1 pc(s)

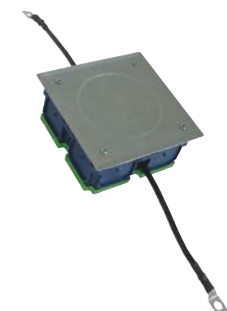



Test Joint Box for External Thermal Insulation Composite Systems

The telescopic test joint box is particularly designed for external thermal insulation composite systems (full thermal insulation). It is continuously adjustable from 90-140 mm. Thanks to the additional spacer, the test joint box can be used for insulation material thicknesses up to 320 mm.

Test joint box with spacer

For insulation material thicknesses between 140 mm and 320 mm.



Part No.	476 055
Material of box	PC / ABS
Dimensions of box	185 x 145 mm
Material of cover	StSt
Material of spacer	PP
Dimensions of spacer	120 x 120 x 200 mm
Installation depth	90-320 mm
PU	1 pc(s)

Test joint box

For external thermal insulation material thicknesses between 90 mm and 140 mm.



Part No.	476 050
Material of box	PC / ABS
Dimensions of box	185 x 145 mm
Material of cover	StSt
Installation depth	90-140 mm
PU	1 pc(s)

Separate spacer

For combination with the test joint box.



Part No.	476 053
Material of spacer	PP
Dimensions of spacer	120 x 120 x 200 mm
PU	1 pc(s)

Inspection Doors

For flush-mounted test joints.



Type StSt with square spanner

For screw mounting (holes Ø8-10 mm) with detachable door.

Part No.	476 020
Material	StSt
Mounting dimensions	200 x 140 mm
Dimensions	290 x 230 mm
PU	1 pc(s)



Type St/tZn with snap lock

Light design for walling in / plastering, with claws (length 60 mm, distance 100 mm).

Part No.	476 100
Material	St/tZn
Mounting dimensions	205 x 155 mm
Dimensions	230 x 180 mm
PU	10 pc(s)



Type St/tZn with square spanner

For walling in / plastering, with claws (length 60 mm, distance 100 mm).

Part No.	476 001
Material	St/tZn
Mounting dimensions	205 x 155 mm
Dimensions	230 x 180 mm
PU	10 pc(s)

Variable Number Plates

Test joints, down conductors and connection lugs can be marked using the variable number plate. On site, the individual pre-embossed numbers can be quickly inserted into the plate without additional tools. This ensures uniform marking.

Assortment case for number plate, variable

Sortimo assortment case with the following content:

- 100 x each of the numbers "0", "1", "2", "3", "4", "5", "6", "7", "8", "9"
- 100 x plain number inset
- 100 x variable number plate with slot
- 300 x combination head screw StSt M6 x 16 mm
- 50 x carrier plate StSt for VDB test badge
- 50 x saddle clamp Al Rd 7-10 mm
- 50 x saddle clamp Al Rd 16 mm



Part No.	490 999
Material	Plastic
Dimensions	450 x 360 x 120 mm
PU	1 pc(s)

Variable number plate for round / flat conductors

Consisting of a number plate with slots (Part No. 490 100), a saddle clamp (Part No. 480 291) and two combination head screws (Part No. 490 020).

Part No.	490 110
Material of plate	Al
Material of saddle clamp	Al
Clamping range Rd / Fl	7-10 / 30 mm
Material of screw	StSt
Screw	☒ M6 x 16 mm
PU	50 pc(s)



Variable number plate for earth entry rods

Consisting of a number plate with slots (Part No. 490 100), a saddle clamp (Part No. 490 022) and two combination head screws (Part No. 490 020).

Part No.	490 116
Material of plate	Al
Material of saddle clamp	Al
Clamping range Rd	16 mm
Material of screw	StSt
Screw	☒ M6 x 16 mm
PU	50 pc(s)



Number plate with slots

Number plate to hold (un)embossed number insets (e.g. Part No. 490 001).

Part No.	490 100
Material	Al
PU	100 pc(s)



"Customised versions with company name and address are available on request."

Embossed number inset

Embossed number inset for slotting into the number plate (Part No. 490 100, 490 110, 490 116) without tools.



General technical data:				
Material	StSt			
Part No.	490 000	490 001	490 002	490 003
Number	0	1	2	3
PU	100 pc(s)	100 pc(s)	100 pc(s)	100 pc(s)
Part No.	490 004	490 005	490 006	
Number	4	5	6	
PU	100 pc(s)	100 pc(s)	100 pc(s)	
Part No.	490 007	490 008	490 009	
Number	7	8	9	
PU	100 pc(s)	100 pc(s)	100 pc(s)	



Plain number inset

Plain number inset for slotting into the number plate (Part No. 490 100, 490 110, 490 116) without tools.

Part No.	490 900
Material	StSt
PU	100 pc(s)



Carrier plate for VDB test badge

For fixing the test badge on the down conductor or earth entry rod.

Part No.	490 021
Material	StSt
Dimensions	84 x 58 x 1 mm
PU	50 pc(s)



Combination head screw

Part No.	490 020
Material	StSt
Screw	⌀ M6 x 16 mm
PU	100 pc(s)



Saddle clamp for number plate

Part No.	480 291	490 022
Material	Al	Al
Clamping range Rd / Fl	7-10 / 30 mm	—
Clamping range Rd	—	16 mm
PU	100 pc(s)	100 pc(s)

All number plates are available with different numbers or lettering on request!

Accessory for Variable Number Plates



Assortment case, empty

Assortment case with inset boxes in different sizes for sorting the content, and with fast click system for safe transportation.

Part No.	490 099
Material	Plastic
Dimensions (l x w x h)	450 x 360 x 120 mm
PU	1 pc(s)

Number Plates

For marking the test joints.

With embossed number for round / flat conductors

The Part No. defines the number embossed.

Example: Number 5 Part No. 481 005

Part No.	481 0xx
Material	Al
Clamping range Rd / Fl	7-10 / 30 mm
PU	1 pc(s)



With embossed number for earth entry rods

The Part No. defines the embossed number.

Example: Number 5 => Part No. 482 005

Part No.	482 0xx
Material	Al
Clamping range Rd	16 mm
PU	1 pc(s)



Without number for round / flat conductors

For on-site labelling with punched numbers 0-9, size 10 mm.

Part No.	480 003
Material	Al
Clamping range Rd / Fl	7-10 / 30 mm
PU	50 pc(s)



Without number for earth entry rods

For on-site labelling with punched numbers 0-9, size 10 mm.

Part No.	480 004
Material	Al
Clamping range Rd	16 mm
PU	50 pc(s)



All number plates are available with different numbers or lettering on request!

Carrier Plate for VDB Test Badge

For attaching the test badge to the down conductor or earth entry.

For round / flat conductors

Part No.	480 113
Material	StSt
Clamping range Rd / Fl	7-10 / 30 mm
Dimensions	84 x 58 x 1 mm
PU	50 pc(s)



Two-Screw Clamp

With M6 thread, for combination with the "Attention! Equipotential bonding" sign (Part No. 480 599) or e.g. with number plates.

Part No.	480 291
Material	Al
Clamping range Rd / Fl	7-10 / 30 mm
PU	100 pc(s)



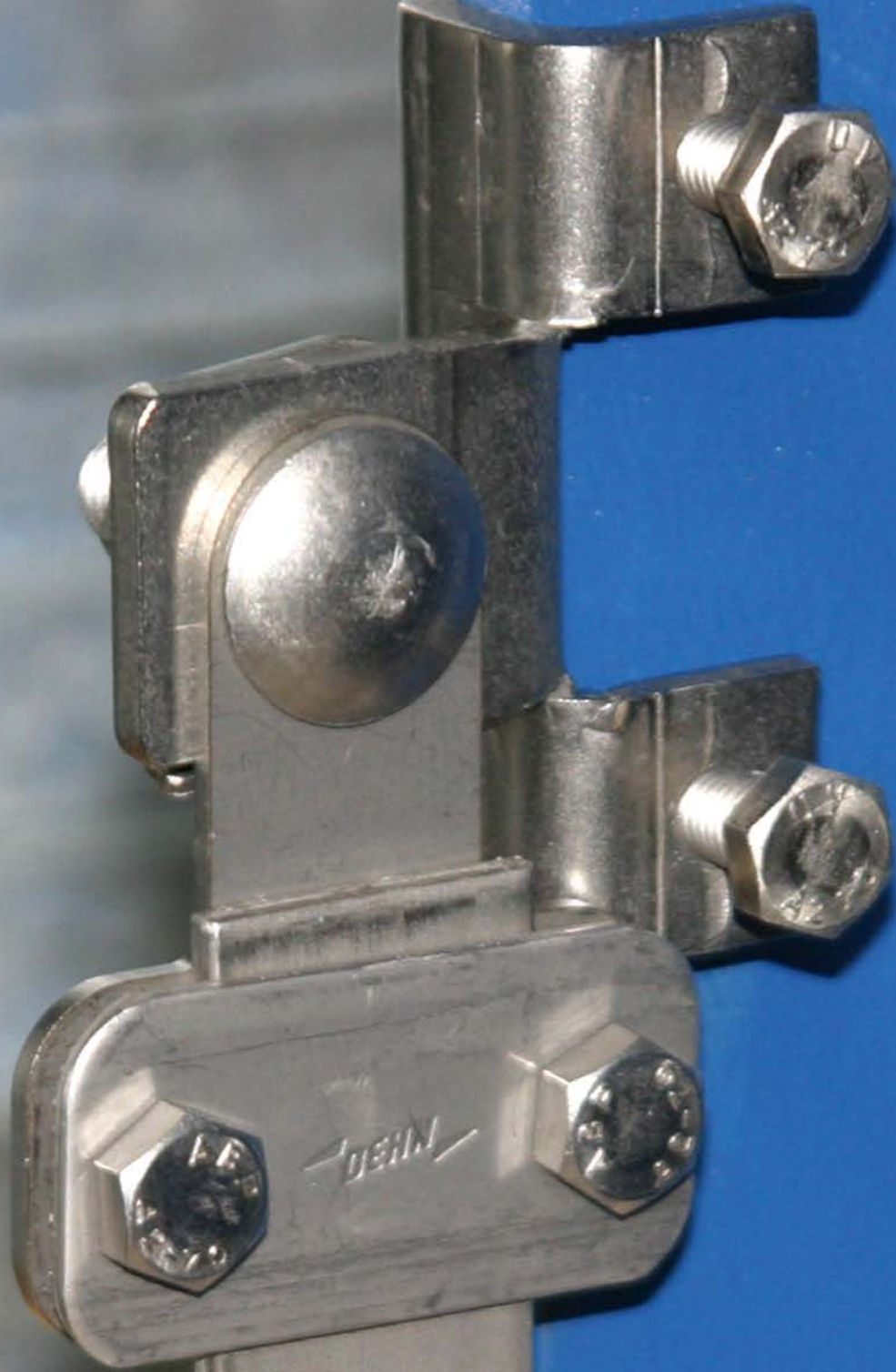

DEHN protects.

MV Clamps

Multipurpose connecting clamp (MehrzweckVerbindungs-Klemme) for universal use as a cross clamp, T clamp and parallel clamp; two-piece.

With hexagon screw

Thread in the base part.

General technical data:				
Standard	EN 62561-1			
Part No.	390 050	390 051	390 059	390 057
Material of clamp	St/tZn	Al	StSt	Cu
Material No.	—	—	—	—
ASTM / AISI:	—	—	—	—
Clamping range Rd	8-10 mm	8-10 mm	8-10 mm	8 mm
Material of screw / nut	St/tZn	StSt	StSt	StSt
Material No.	—	—	—	—
ASTM / AISI:	—	—	—	—
Short-circuit current (50 Hz) (1 s; ≤ 300 °C)	5.5 kA	—	—	—
PU	50 pc(s)	50 pc(s)	50 pc(s)	50 pc(s)
Part No.	391 050	391 059	390 079	
Material of clamp	St/tZn	StSt	StSt (V4A)	
Material No.	—	—	1.4571 / 1.4404	
ASTM / AISI:	—	—	316Ti / 316L / 316	
Clamping range Rd	10 mm	10 mm	8-10 mm	
Material of screw / nut	St/tZn	StSt	StSt (V4A)	
Material No.	—	—	1.4401	
ASTM / AISI:	—	—	316Ti / 316L / 316	
Short-circuit current (50 Hz) (1 s; ≤ 300 °C)	—	—	4.7 kA	
PU	50 pc(s)	50 pc(s)	50 pc(s)	

Note: Part No. 390 079 made of StSt (V4A) can also be used underground.

With hexagon screw and spring washer

Thread in the base part.

General technical data:			
Standard	EN 62561-1		
Part No.	390 550	390 551	390 559
Material of clamp	St/tZn	Al	StSt
Clamping range Rd	8-10 mm	8-10 mm	8-10 mm
Material of screw / nut	St/tZn	StSt	StSt
PU	50 pc(s)	50 pc(s)	50 pc(s)
Part No.	390 557	391 550	391 559
Material of clamp	Cu	St/tZn	StSt
Clamping range Rd	8 mm	10 mm	10 mm
Material of screw / nut	StSt	St/tZn	StSt
PU	50 pc(s)	50 pc(s)	50 pc(s)

With truss head screw

and anti-rotation locking (square hole in the upper part).

General technical data:			
Standard	EN 62561-1		
Part No.	390 060	390 061	390 067
Material of clamp	St/tZn	Al	Cu
Clamping range Rd	8-10 mm	8-10 mm	8 mm
Material of screw / nut	St/tZn	St/tZn	StSt
PU	50 pc(s)	50 pc(s)	50 pc(s)
Part No.	391 060	391 069	390 063
Material of clamp	St/tZn	StSt	St/tZn
Clamping range Rd	10 mm	10 mm	8-10 mm
Material of screw / nut	St/tZn	StSt	StSt
PU	50 pc(s)	50 pc(s)	50 pc(s)





With hexagon screw and spring washer for air-termination rods

Thread in the base part

Part No.	392 050	392 059
Material of clamp	St/tZn	StSt
Clamping range Rd	8-10 / 16 mm	8-10 / 16 mm
Material of screw / nut	St/tZn	StSt
Standard	EN 62561-1	EN 62561-1
PU	50 pc(s)	50 pc(s)



With truss head screw for air-termination rods

and anti-rotation locking (square hole in the upper part).

Part No.	392 060	392 069
Material of clamp	St/tZn	StSt
Clamping range Rd	8-10 / 16 mm	8-10 / 16 mm
Material of screw / nut	St/tZn	StSt
Standard	EN 62561-1	EN 62561-1
PU	50 pc(s)	50 pc(s)



Bimetallic MV clamp

For connecting conductors made of different materials, with intermediate plate (Cupal) and thread in the base part.

Part No.	390 657
Material of clamp	Cu / Al
Clamping range Rd Cu	8 mm
Clamping range Rd Al	8-10 mm
Material of screw / nut	StSt
Standard	EN 62561-1
PU	50 pc(s)



MMV Clamps

Mini multipurpose connecting clamp (Mini-MehrzweckVerbindungs-Klemme) for universal use as a cross clamp, T clamp and parallel clamp, with anti-rotation protection.



With truss head screw

Part No.	390 250	390 257	390 259
Material of clamp	St/tZn	Cu	StSt
Clamping range Rd	6-8 mm	6-8 mm	6-8 mm
Standard	EN 62561-1	EN 62561-1	EN 62561-1
PU	50 pc(s)	50 pc(s)	50 pc(s)

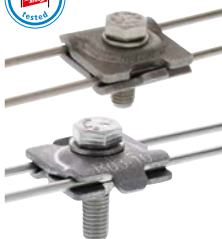

With hexagon screw

Part No.	390 565	540 271
Material of clamp	St/bare	StSt (V4A)
Material No.	—	1.4571 / 1.4404 / 1.4401
Clamping range Rd / Rd	8-10 / 3-5 mm	8-10 / 3-5 mm
Clamping range Rd / Rd	3-5 / 3-5 mm	3-5 / 3-5 mm
Lightning impulse current carrying capability (10/350 μs)	50 kA	25 kA
Standard	EN 62561-1	based on EN 62561-1
PU	50 pc(s)	50 pc(s)



Bimetallic MMV clamp

For connecting conductors made of different materials, with intermediate plate (Cupal).

Part No.	390 267
Material of clamp	Cu / St/tZn
Clamping range Rd Cu	6-8 mm
Clamping range Rd St/tZn	6-8 mm
Standard	EN 62561-1
PU	1 pc(s)

MAXI MV Clamps

MAXI multipurpose connecting clamp (MAXI-MehrzweckVerbindungs-Klemme) for universal use as cross clamp, T clamp and parallel clamp, for connecting earth rods or reinforcements; three-part, with thread in the base part.

With hexagon screw

Part No.	308 041	308 040
Material of clamp	St/tZn	St/bare
Clamping range Rd	8-16 / 15-25 mm	8-16 / 15-25 mm
Material thickness	3.0 / 2.0 mm	3.0 / 2.0 mm
Standard	EN 62561-1	EN 62561-1
Short-circuit current (50 Hz) (1 s; ≤ 300 °C)	6.2 kA	10.2 kA
Approval	—	UL467B
Stock No.	5999-12-362-1557	—
PU	20 pc(s)	20 pc(s)



Clamping Piece Variants

For example as a connection with end piece for constructions or downpipe clamps. Clamping piece with square hole 11 mm and truss head screw.

Part No.	390 150	390 157	390 159
Material of clamp	St/tZn	Cu	StSt
Clamping range Rd	6-10 mm	6-10 mm	6-10 mm
Screw	⬆ M10 x 35 mm	⬆ M10 x 35 mm	⬆ M10 x 35 mm
Material of screw / nut	St/tZn	StSt	StSt
Standard	EN 62561-1	EN 62561-1	EN 62561-1
PU	100 pc(s)	1 pc(s)	100 pc(s)



KS Connectors

Clamping screw connector (KlemmSchrauben-Verbinder) for lightning current carrying connection of round conductors, e.g. to flat profiles, downpipe clamps or other parts of the lightning protection system.

One-piece, St/tZn With screw and nut M10.

Part No.	301 000	301 010
Material of clamping screw	St/tZn	St/tZn
Material of clamp	ZDC	ZDC
Clamping range Rd	7-10 mm	7-10 mm
Type	—	+ spring washer
Standard	EN 62561-1	EN 62561-1
PU	100 pc(s)	100 pc(s)

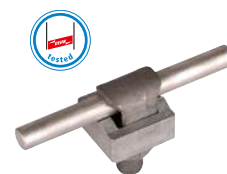

One-piece, Cu With screw and nut M10.

Part No.	301 007	301 017
Material of clamping screw	Cu	Cu
Material of clamp	Gunmetal	Gunmetal
Clamping range Rd	6-10 mm	6-10 mm
Connection (single-wire / multi-wire)	25-70 mm ²	25-70 mm ²
Type	—	+ spring washer
Standard	EN 62561-1	EN 62561-1
PU	1 pc(s)	1 pc(s)

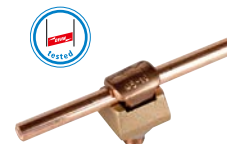

One-piece, StSt With screw and nut M10.

Part No.	301 009	301 089	301 019	301 099	540 122
Material of clamping screw	StSt	StSt (V4A)	StSt	StSt (V4A)	StSt (V4A)
Material of clamp	StSt	StSt (V4A)	StSt	StSt (V4A)	StSt (V4A)
Clamping range Rd	6-10 mm	6-10 mm	6-10 mm	6-10 mm	6-10 mm
Connection (single-wire / multi-wire)	25-70 mm ²	25-70 mm ²	25-70 mm ²	25-70 mm ²	16-50 mm ²
Type	—	—	+ spring washer	+ spring washer	+ spring washer
Standard	EN 62561-1	EN 62561-1	EN 62561-1	EN 62561-1	EN 62561-1
PU	100 pc(s)	100 pc(s)	100 pc(s)	100 pc(s)	25 pc(s)

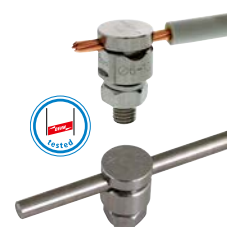

Clamps, Connectors

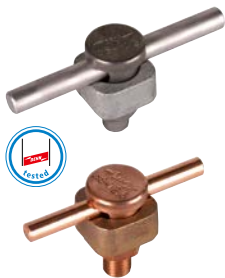

Heavy design With screw and nut M12.

Part No.	300 002	300 017
Material of clamping screw	St/tZn	Cu
Material of clamp	MCI	Gunmetal
Clamping range Rd	8-12.5 mm	8-12.5 mm
Connection (single-wire / multi-wire)	50-95 mm ²	50-95 mm ²
Standard	EN 62561-1	EN 62561-1
PU	25 pc(s)	1 pc(s)

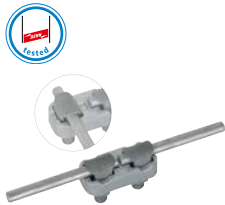

Two-piece, gap 30 mm With screw and nut M10.

Part No.	302 010
Material of clamping screw	St/tZn
Material of clamp	ZDC
Clamping range Rd	7-10 mm
Standard	EN 62561-1
PU	50 pc(s)

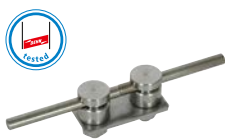

Two-piece, gap 40 mm With screw and nut M10.

Part No.	301 229
Material of clamping screw	StSt
Material of clamp	StSt
Clamping range Rd	6-10 mm
Type	+ spring washer
Standard	EN 62561-1
PU	1 pc(s)

Connectors

For connecting round conductors in T and longitudinal arrangements.

EST connector One-screw T connector.

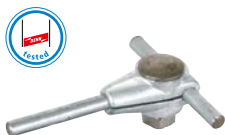

Part No.	310 008
Material of clamp	ZDC
Clamping range Rd	8 mm
Standard	EN 62561-1
PU	50 pc(s)



ES connectors One-screw connectors for longitudinal arrangements.

Part No.	309 008	309 087
Material of clamp	ZDC	Gunmetal
Clamping range Rd	8 mm	8 mm
Standard	EN 62561-1	EN 62561-1
PU	50 pc(s)	50 pc(s)

ES Disconnecting Clamp

Single-screw disconnecting clamp (Ein-Schrauben-Trennklemme) for connecting down conductors with earth entries.



Part No.	463 010
Material	ZDC
Clamping range Rd / Rd	8 / 10 mm
Standard	EN 62561-1
PU	50 pc(s)

Universal Connector

For connecting round conductors in cross, T, and parallel arrangements and for twin conductor connection.

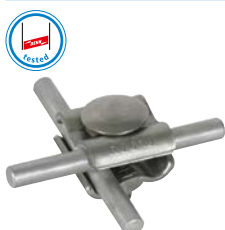

Part No.	315 119
Material of clamp	StSt
Clamping range Rd	8-10 mm
Standard	EN 62561-1
PU	50 pc(s)

Parallel Connectors

For connecting two conductors in parallel arrangement.

For equal diameters with one screw

Part No.	306 020	306 029
Material of clamp	St/tZn	StSt (V4A)
Material No.	—	1.4571 / 1.4404 / 1.4401
ASTM / AISI:	—	316Ti / 316L / 316
Clamping range Rd / Rd	7-10 mm	7-10 mm
Standard	EN 62561-1	EN 62561-1
Short-circuit current (50 Hz) (1 s; ≤ 300 °C)	4.0 kA	2.9 kA
PU	50 pc(s)	50 pc(s)

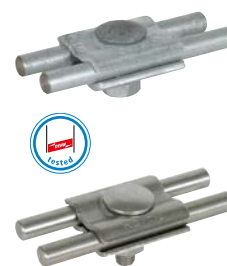

For equal diameters with two screws

Part No.	307 000	307 007
Material of clamp	St/tZn	Cu
Clamping range Rd / Rd	7-10 mm	7-10 mm
Standard	EN 62561-1	EN 62561-1
Military Name	VG 96953 T06 D0002	—
Stock No.	5999-12-158-2303	—
PU	50 pc(s)	1 pc(s)

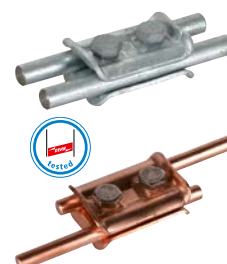

For different diameters with one screw

Part No.	306 121	306 122
Material of clamp	St/bare	St/tZn
Clamping range Rd / Rd	6-22 / 6-22 mm	6-22 / 6-22 mm
Standard	EN 62561-1	EN 62561-1
Short-circuit current (50 Hz) (1 s; ≤ 300 °C)	6.1 kA	6.1 kA
PU	50 pc(s)	50 pc(s)



For different diameters 4-10 mm with two screws

Part No.	305 000	305 007
Material of clamp	St/tZn	Cu
Clamping range Rd / Rd	4-10 mm	4-10 mm
Standard	EN 62561-1	EN 62561-1
Short-circuit current (50 Hz) (1 s; ≤ 300 °C)	—	13.6 kA
PU	50 pc(s)	50 pc(s)

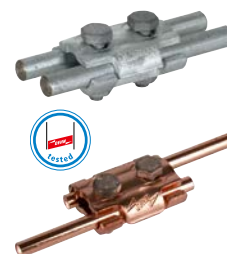

For equal and different cable diameters, small

With thread in the base part and lock nut M8.
Specified short-circuit current applies to 70 mm² Cu cable.

Part No.	306 100
Material of clamp	Cu
Clamping range Rd / Rd	5-12.5 mm
Clamping range (stranded / cable)	16-95 mm ²
Standard	EN 62561-1
Short-circuit current (50 Hz) (1 s; ≤ 300 °C)	13.6 kA
PU	25 pc(s)

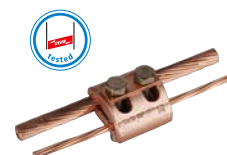

For equal and different cable diameters, large

With thread in the base part and lock nut M10.
Specified short-circuit current applies to 70 mm² Cu cable.

Part No.	306 101
Material of clamp	Cu
Clamping range Rd / Rd	5-16 mm
Clamping range (stranded / cable)	16-150 mm ²
Standard	EN 62561-1
Short-circuit current (50 Hz) (1 s; ≤ 300 °C)	13.6 kA
PU	25 pc(s)

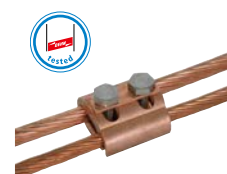

Connecting Sleeves

For longitudinal connection of two round conductors with four screws.

ZDC 8



Part No.	385 203
Material of clamp	ZDC
Clamping range Rd	8 mm
Screw	☒ M6 x 10 mm
Standard	EN 62561-1
PU	50 pc(s)

ZDC 7-10



Part No.	385 202
Material of clamp	ZDC
Clamping range Rd	7-10 mm
Screw	☒ M6 x 12 mm
Standard	EN 62561-1
PU	50 pc(s)

Al 8



Part No.	385 213
Material of clamp	Al
Clamping range Rd	8 mm
Screw	☒ M6 x 8 mm
Standard	EN 62561-1
PU	50 pc(s)

Cu 8



Part No.	385 207
Material of clamp	Cu
Clamping range Rd	8 mm
Screw	☒ M6 x 8 mm
Standard	EN 62561-1
PU	50 pc(s)

Cross Units for Aboveground Connections

For cross and T connection of conductors.

Without intermediate plate

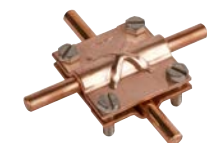

Part No.	314 300	314 307
Material of clamp	St/tZn	Cu
Clamping range Rd / Rd	8-10 / 8-10 mm	8-10 / 8-10 mm
Clamping range Rd / FI	8-10 / 30 mm	8-10 / 30 mm
Clamping range FI / FI	30 / 30 mm	30 / 30 mm
Dimensions	50 x 50 x 2.5 mm	50 x 50 x 2.5 mm
Standard	EN 62561-1	EN 62561-1
PU	50 pc(s)	50 pc(s)

With intermediate plate



Part No.	314 310
Material of clamp	St/tZn
Clamping range Rd / Rd	8-10 / 8-10 mm
Clamping range Rd / FI	8-10 / 30 mm
Clamping range FI / FI	30 / 30 mm
Dimensions	50 x 50 x 2.5 mm
Standard	EN 62561-1
PU	50 pc(s)

With intermediate plate, e.g. for air-termination rods

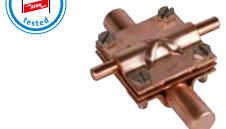

Part No.	316 163	316 167
Material of clamp	St/tZn	Cu
Clamping range Rd / Rd	16 / 8-10 mm	16 / 8-10 mm
Clamping range Rd / FI	16 / 30 mm	16 / 30 mm
Dimensions	50 x 50 x 2.5 mm	50 x 50 x 2.5 mm
Standard	EN 62561-1	EN 62561-1
PU	1 pc(s)	25 pc(s)

Cross Units for Aboveground and Underground Connections

For cross and T connection.

With intermediate plate, for round and flat conductors

Part No.	319 201	319 207	319 209
Material of clamp	St/tZn	Cu	StSt (V4A)
Clamping range Rd / Rd	8-10 / 8-10 mm	8-10 / 8-10 mm	8-10 / 8-10 mm
Clamping range Rd / Fl	8-10 / 30 mm	8-10 / 30 mm	8-10 / 30 mm
Clamping range Fl / Fl	30 / 30 mm	30 / 30 mm	30 / 30 mm
Clamping range (stranded / cable)	—	50-70 mm ²	50-70 mm ²
ASTM / AISI:	—	316Ti / 316L / 316	316Ti / 316L / 316
Dimensions	60 x 60 x 3 mm	60 x 60 x 3 mm	60 x 60 x 3 mm
Standard	EN 62561-1	EN 62561-1	EN 62561-1
Short-circuit current (50 Hz) (1 s; ≤ 300 °C)	14 kA	29 kA	7 kA
PU	25 pc(s)	25 pc(s)	25 pc(s)

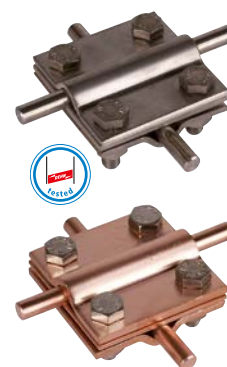

With intermediate plate, for round and flat conductors up to 40 mm

Part No.	321 045	321 047
Material of clamp	St/tZn	Cu
Clamping range Rd / Fl	8-10 / 30-40 mm	8-10 / 30-40 mm
Clamping range Fl / Fl	30-40 / 30-40 mm	30-40 / 30-40 mm
Clamping range (stranded / cable)	—	50-70 mm ²
ASTM / AISI:	—	316Ti / 316L / 316
Dimensions	70 x 70 x 3 mm	70 x 70 x 3 mm
Standard	EN 62561-1	EN 62561-1
Short-circuit current (50 Hz) (1 s; ≤ 300 °C)	12.6 kA	35.1 kA
PU	25 pc(s)	25 pc(s)

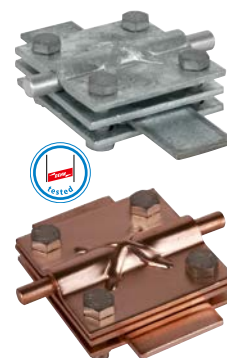

With intermediate plate, for two round and flat conductors up to 40 mm

Part No.	319 229
Material of clamp	StSt (V4A)
Clamping range Rd / Rd	7-10 / 7-10 mm
Clamping range Rd / Fl	7-10 / 30-40 mm
Clamping range Fl / Fl	30-40 / 30-40 mm
Clamping range (stranded / cable)	35-70 mm ²
ASTM / AISI:	316Ti / 316L / 316
Dimensions	70 x 70 x 3 mm
Standard	EN 62561-1
Short-circuit current (50 Hz) (1 s; ≤ 300 °C)	5.0 kA
PU	25 pc(s)

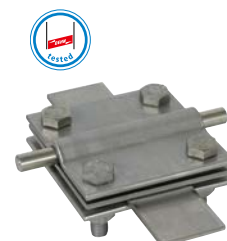

With intermediate plate, for earth entries / air-termination rods

Part No.	319 202	319 219
Material of clamp	St/tZn	StSt (V4A)
Clamping range Rd / Rd	16 / 8-10 mm	16 / 8-10 mm
Clamping range Rd / Fl	16 / 30 mm	16 / 30 mm
Clamping range (stranded / cable)	—	50-70 / 120 mm ²
ASTM / AISI:	—	316Ti / 316L / 316
Dimensions	60 x 60 x 3 mm	60 x 60 x 3 mm
Standard	EN 62561-1	EN 62561-1
PU	25 pc(s)	25 pc(s)

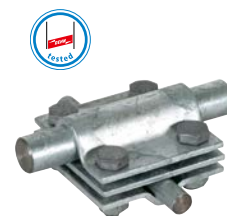

Without intermediate plate, for round and flat conductors

Part No.	318 201	318 207	318 209
Material of clamp	St/tZn	Cu	StSt (V4A)
Clamping range Rd / Fl	8-10 / 30 mm	8-10 / 30 mm	8-10 / 30 mm
Clamping range Fl / Fl	30 / 30 mm	30 / 30 mm	30 / 30 mm
Clamping range (stranded / cable)	—	50-70 mm ²	50-70 mm ²
ASTM / AISI:	—	316Ti / 316L / 316	316Ti / 316L / 316
Dimensions	60 x 60 x 3 mm	60 x 60 x 3 mm	60 x 60 x 3 mm
Standard	EN 62561-1	EN 62561-1	EN 62561-1
Short-circuit current (50 Hz) (1 s; ≤ 300 °C)	14 kA	29 kA	7.4 kA
PU	25 pc(s)	1 pc(s)	25 pc(s)

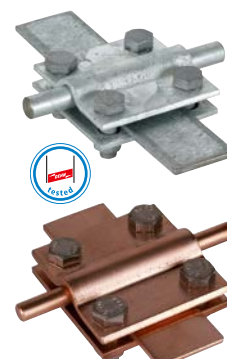



Without intermediate plate, for two round and flat conductors

Part No.	318 251	318 219
Material of clamp	St/tZn	StSt (V4A)
Clamping range Rd / Rd	8-10 / 8-10 mm	8-10 / 8-10 mm
Clamping range Rd / Fl	8-10 / 30 mm	8-10 / 30 mm
Clamping range Fl / Fl	30 / 30 mm	30 / 30 mm
Clamping range (stranded / cable)	—	50-70 mm ²
ASTM / AISI:	—	316Ti / 316L / 316
Dimensions	60 x 60 x 3 mm	60 x 60 x 3 mm
Standard	EN 62561-1	EN 62561-1
Short-circuit current (50 Hz) (1 s; ≤ 300 °C)	14 kA	7.4 kA
PU	25 pc(s)	25 pc(s)

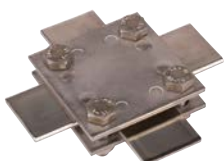

Without intermediate plate, for two flat conductors

Part No.	318 033	318 233
Material of clamp	St/tZn	StSt (V4A)
Clamping range Fl / Fl	30 / 30 mm	30 / 30 mm
ASTM / AISI:	—	316Ti / 316L / 316
Dimensions	60 x 60 x 3 mm	60 x 60 x 3 mm
Standard	EN 62561-1	EN 62561-1
Short-circuit current (50 Hz) (1 s; ≤ 300 °C)	8.4 kA	7.0 kA
PU	25 pc(s)	25 pc(s)



Without intermediate plate, for two flat conductors up to 40 mm

Part No.	320 044
Material of clamp	St/tZn
Clamping range Fl / Fl	30-40 / 30-40 mm
Dimensions	70 x 70 x 3 mm
Standard	EN 62561-1
Short-circuit current (50 Hz) (1 s; ≤ 300 °C)	12.6 kA
PU	25 pc(s)



Without intermediate plate, for earth entries / air-termination rods

Part No.	318 252
Material of clamp	St/tZn
Clamping range Rd / Rd	8-10 / 16 mm
Clamping range Rd / Fl	16 / 30 mm
Dimensions	60 x 60 x 3 mm
Standard	EN 62561-1
PU	25 pc(s)

Cross Units with Truss Head Screws for Aboveground and Underground Connections

For conductors in cross and T arrangement. Version with anti-rotation protection for mounting with a tool.

With intermediate plate for round and flat conductors



Part No.	318 203	318 229
Material of clamp	St/tZn	StSt (V4A)
ASTM / AISI:	—	316Ti / 316L / 316
Clamping range Rd / Rd	8-10 / 8-10 mm	8-10 / 8-10 mm
Clamping range Rd / Fl	8-10 / 30 mm	8-10 / 30 mm
Clamping range Fl / Fl	30 / 30 mm	30 / 30 mm
Clamping range (stranded / cable)	—	50-70 mm ²
ASTM / AISI:	—	316Ti / 316L / 316
Dimensions	60 x 60 x 3 mm	60 x 60 x 3 mm
Standard	EN 62561-1	EN 62561-1
Short-circuit current (50 Hz) (1 s; ≤ 300 °C)	14 kA	7 kA
PU	1 pc(s)	25 pc(s)

Without intermediate plate for round and flat conductors

Part No.	318 205	318 239
Material of clamp	St/tZn	StSt (V4A)
ASTM / AISI:	—	316Ti / 316L / 316
Clamping range Rd / Fl	8-10 / 30 mm	8-10 / 30 mm
Clamping range Fl / Fl	30 / 30 mm	30 / 30 mm
Clamping range (stranded / cable)	—	50-70 mm ²
ASTM / AISI:	—	316Ti / 316L / 316
Dimensions	60 x 60 x 3 mm	60 x 60 x 3 mm
Standard	EN 6561-1	EN 62561-1
Short-circuit current (50 Hz) (1 s; ≤ 300 °C)	14 kA	7.4 kA
PU	25 pc(s)	25 pc(s)



SV Clamps for Underground Connections

SV clamps (Schräg-Verbinder-Klemmen) for cross and T connections.

Part No.	308 062
Material of clamp	St/bare
Clamping range Rd / Fl	6-28 / 30 mm
Standard	EN 62561-1
Short-circuit current (50 Hz) (1 s; ≤ 300 °C)	7.3 kA
PU	50 pc(s)



SV Clamps for Aboveground and Underground Connections

Diagonal connecting clamps (Schräg-Verbinder-Klemmen) for cross and T connections, screws with anti-rotation protection.

For flat and round conductors

Part No.	308 220	308 229	308 320	308 329
Material of clamp	St/tZn	StSt (V4A)	St/tZn	StSt (V4A)
Clamping range Rd / Rd	7-10 / 7-10 mm	7-10 / 7-10 mm	7-10 / 7-10 mm	7-10 / 7-10 mm
Clamping range Rd / Fl	7-10 / 30 mm	7-10 / 30 mm	7-10 / 30-40 mm	7-10 / 30-40 mm
Clamping range Fl / Fl	30 / 30 mm	30 / 30 mm	30-40 / 30-40 mm	30-40 / 30-40 mm
Screw	⬆ M10 x 30 mm	⬆ M10 x 30 mm	⬆ M10 x 30 mm	⬆ M10 x 30 mm
ASTM / AISI:	—	316Ti / 316L / 316	—	316Ti / 316L / 316
Dimensions (l x d)	94 x 4 mm	94 x 3 mm	108 x 4 mm	108 x 3 mm
Standard	EN 62561-1	EN 62561-1	EN 62561-1	EN 62561-1
Short-circuit current (50 Hz) (1 s; ≤ 300 °C)	7.3 kA	3.2 kA	14.0 kA	14.0 kA
PU	25 pc(s)	25 pc(s)	25 pc(s)	25 pc(s)



For one flat and one round conductor

Part No.	308 249
Material of clamp	StSt (V4A)
Clamping range Rd / Fl	7-10 / 30 mm
Screw	⬆ M10 x 30 mm
ASTM / AISI:	316Ti / 316L / 316
Dimensions (l x d)	94 x 3 mm
Standard	EN 62561-1
PU	25 pc(s)



For flat conductors

Part No.	308 230	308 239
Material of clamp	St/tZn	StSt (V4A)
Clamping range Fl / Fl	30 / 30 mm	30 / 30 mm
Screw	⬆ M10 x 30 mm	⬆ M10 x 30 mm
ASTM / AISI:	—	316Ti / 316L / 316
Dimensions (l x d)	94 x 4 mm	94 x 3 mm
Standard	EN 62561-1	EN 62561-1
Short-circuit current (50 Hz) (1 s; ≤ 300 °C)	8.2 kA	3.9 kA
PU	25 pc(s)	25 pc(s)



Clamps, Connectors



For flat conductors, round conductors and earth entry rods

Part No.	308 330
Material of clamp	St/tZn
Clamping range Rd / Rd	7-10 / 16 mm
Clamping range Rd / FI	16 / 30-40 mm
Screw	⬆ M10 x 30 mm
Dimensions (l x d)	108 x 4 mm
Standard	EN 62561-1
PU	25 pc(s)

SVP Clamps for Aboveground and Underground Connections

Diagonal and parallel connecting clamps (Schräg-Verbinder-Parallel-Klemmen) for cross and parallel connections, with slotted upper part (no need to detach the screws).

Without intermediate plate



Part No.	308 060
Material of clamp	St/tZn
Clamping range Rd / Rd	8-10 / 8-10 mm
Clamping range Rd / FI	8-10 / 30 mm
Clamping range FI / FI	30 / 30 mm
Standard	EN 62561-1
PU	50 pc(s)

With intermediate plate (slotted)



Part No.	308 070
Material of clamp	St/tZn
Clamping range Rd / Rd	8-10 / 8-10 mm
Clamping range Rd / FI	8-10 / 30 mm
Clamping range FI / FI	30 / 30 mm
Standard	EN 62561-1
PU	1 pc(s)

Connection Clamps

For connection to steel constructions and steel sheets.

Longitudinal or cross connection



Part No.	371 009	371 007
Clamping range	0.4-12 mm	0.4-12 mm
Material of clamp	MCI/tZn	Gunmetal
Clamping range Rd	7-10 mm	7-10 mm
Standard	EN 62561-1	EN 62561-1
PU	20 pc(s)	1 pc(s)

Longitudinal connection



Part No.	371 008
Clamping range	0.4-12 mm
Material of clamp	MCI/tZn
Clamping range Rd	4-10 mm
Standard	EN 62561-1
PU	50 pc(s)

Longitudinal or cross connection with KS screw



Part No.	370 014
Clamping range	1-12 mm
Material of clamp	MCI/tZn
Clamping range Rd	7-10 mm
Standard	EN 62561-1
PU	25 pc(s)

Longitudinal or cross connection with KS screw



Part No.	370 018
Clamping range	8-18 mm
Material of clamp	MCI/tZn
Clamping range Rd	7-10 mm
Standard	EN 62561-1
PU	25 pc(s)

Connection Clamps for Steel Girders

Heavy design, for connection to steel constructions.

Vertical design, with clamping piece

Lengthwise or crosswise connection with clamping piece.

Part No.	372 110	372 119	372 140	372 149
Clamping range	3-18 mm	3-18 mm	18-35 mm	18-35 mm
Material of clamp	St/tZn	StSt	St/tZn	StSt
Clamping range Rd	6-10 mm	6-10 mm	6-10 mm	6-10 mm
Standard	EN 62561-1	EN 62561-1	EN 62561-1	EN 62561-1
PU	25 pc(s)	25 pc(s)	25 pc(s)	25 pc(s)



Horizontal design, with clamping piece

Lengthwise or crosswise connection with clamping piece.

Part No.	372 210	372 219	372 240	372 249
Clamping range	3-18 mm	3-18 mm	18-35 mm	18-35 mm
Material of clamp	St/tZn	StSt	St/tZn	StSt
Clamping range Rd	6-10 mm	6-10 mm	6-10 mm	6-10 mm
Standard	EN 62561-1	EN 62561-1	EN 62561-1	EN 62561-1
PU	25 pc(s)	25 pc(s)	25 pc(s)	1 pc(s)



Vertical design, with KS connector

Lengthwise or crosswise connection with KS connector.

Part No.	372 120	372 129	372 150	372 159
Clamping range	3-18 mm	3-18 mm	18-35 mm	18-35 mm
Material of clamp	St/tZn	StSt	St/tZn	StSt
Clamping range Rd	7-10 mm	6-10 mm	7-10 mm	6-10 mm
Standard	EN 62561-1	EN 62561-1	EN 62561-1	EN 62561-1
PU	25 pc(s)	25 pc(s)	25 pc(s)	25 pc(s)



Horizontal design, with KS connector

Lengthwise or crosswise connection with KS connector.

Part No.	372 220	372 229	372 250	372 259
Clamping range	3-18 mm	3-18 mm	18-35 mm	18-35 mm
Material of clamp	St/tZn	StSt	St/tZn	StSt
Clamping range Rd	7-10 mm	6-10 mm	7-10 mm	6-10 mm
Standard	EN 62561-1	EN 62561-1	EN 62561-1	EN 62561-1
PU	25 pc(s)	25 pc(s)	25 pc(s)	25 pc(s)



Connection Clamps with Thrust Piece

For connection to steel constructions and steel sheets with a single-screw technique.

Small design

Lengthwise or crosswise connection.

Part No.	372 018	372 019
Clamping range	5-18 mm	5-18 mm
Material of clamp	St/tZn	StSt
Clamping range Rd	6-10 mm	6-10 mm
Standard	EN 62561-1	EN 62561-1
PU	25 pc(s)	25 pc(s)



Large design

Lengthwise or crosswise connection.

Part No.	372 035
Clamping range	18-35 mm
Material of clamp	St/tZn
Clamping range Rd	6-10 mm
Standard	EN 62561-1
PU	25 pc(s)



Seam Clamps

For connecting conductors with seams of the same or of different materials.

With clamping piece

Longitudinal or cross conductor routing.

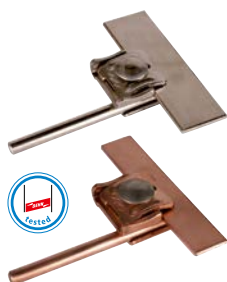

Part No.	365 030	365 031	365 037	365 039
Clamping range of seam	0.7-8 mm	0.7-8 mm	0.7-8 mm	0.7-8 mm
Material of clamp	St/tZn	Al	Cu	StSt
Clamping range Rd	6-10 mm	6-10 mm	6-10 mm	6-10 mm
Standard	EN 62561-1	EN 62561-1	EN 62561-1	EN 62561-1
PU	50 pc(s)	50 pc(s)	50 pc(s)	50 pc(s)

With double clamp

Longitudinal or cross conductor routing.

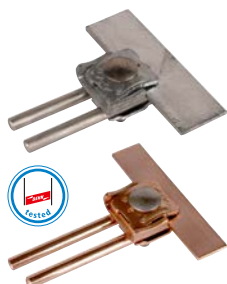

Part No.	365 010	365 017	365 019
Clamping range of seam	0.7-8 mm	0.7-8 mm	0.7-8 mm
Material of clamp	St/tZn	Cu	StSt
Clamping range Rd	8-10 mm	8-10 mm	8-10 mm
Standard	EN 62561-1	EN62561-1	EN 62561-1
PU	50 pc(s)	50 pc(s)	50 pc(s)

With two-screw clamp

Longitudinal or cross conductor routing.

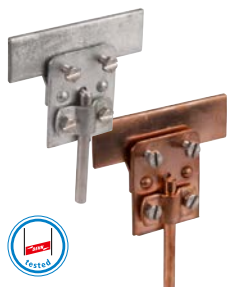

Part No.	251 002	251 027
Clamping range of seam	0.7-5 mm	0.7-5 mm
Material of clamp	St/tZn	Cu
Clamping range Rd	7-10 mm	7-10 mm
Standard	EN 62561-1	EN 62561-1
PU	50 pc(s)	1 pc(s)

With two-screw clamp, e.g. for standing seams

Longitudinal or cross conductor routing.

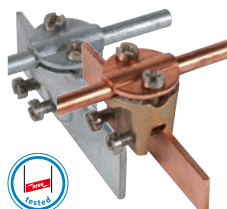

Part No.	365 000	365 007
Clamping range of seam	0.7-6 mm	0.7-6 mm
Material of clamp	ZDC	Gunmetal
Clamping range Rd	7-10 mm	7-10 mm
Standard	EN 62561-1	EN 62561-1
PU	50 pc(s)	50 pc(s)

With clamping piece, for hooking under seams

Which are close to a roof or wall surface.

Longitudinal or cross conductor routing.

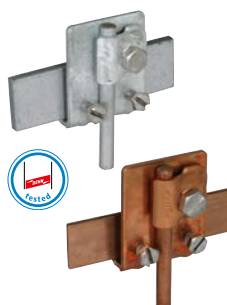

Part No.	365 020	365 027
Clamping range of seam	0.7-10 mm	0.7-10 mm
Material of clamp	St/tZn	Cu
Clamping range Rd	6-10 mm	6-10 mm
Standard	EN 62561-1	EN 62561-1
PU	50 pc(s)	50 pc(s)

With two-screw clamp, for hooking under seams

Which are close to a roof or wall surface.

Longitudinal or cross conductor routing.

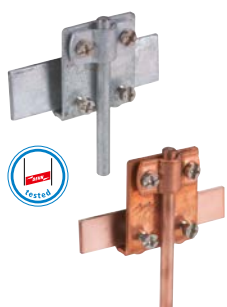

Part No.	365 040	365 047
Clamping range of seam	0.7-10 mm	0.7-10 mm
Material of clamp	St/tZn	Cu
Clamping range Rd	7-10 mm	7-10 mm
Standard	EN 62561-1	EN 62561-1
PU	50 pc(s)	1 pc(s)

Clamps, Connectors

Bimetallic, for Cu seams, with intermediate plate (Cupal)

Part No.	365 117
Clamping range of seam	0.7-8 mm
Material of clamp	St/tZn / Cu
Clamping range Rd	6-10 mm
Standard	EN 62561-1
PU	1 pc(s)

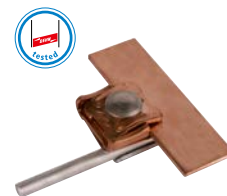

Bimetallic, for St/tZn seams, with intermediate plate (Cupal)

Part No.	365 127
Clamping range of seam	0.7-8 mm
Material of clamp	Cu / St/tZn
Clamping range Rd	6-10 mm
PU	1 pc(s)



Saddle Clamps with Enlarged Contact Surface

For connecting conductors with seams; enlarged contact surface.

Angled design

Longitudinal or cross conductor routing.

Part No.	365 050	365 051	365 057	365 059
Clamping range of seam	0.7-8 mm	0.7-8 mm	0.7-8 mm	0.7-8 mm
Material of clamp	St/tZn	Al	Cu	StSt
Clamping range Rd	6-10 mm	6-10 mm	6-10 mm	6-10 mm
Standard	EN 62561-1	EN 62561-1	EN 62561-1	EN 62561-1
PU	50 pc(s)	50 pc(s)	50 pc(s)	50 pc(s)

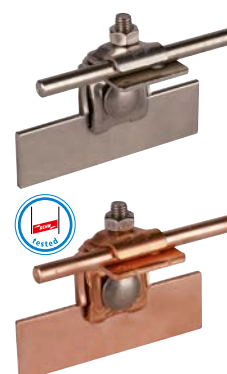

Straight design

Longitudinal or cross conductor routing.

Part No.	365 220	365 221	365 227	365 229
Clamping range of seam	0.7-10 mm	0.7-10 mm	0.7-10 mm	0.7-10 mm
Material of clamp	St/tZn	Al	Cu	StSt
Clamping range Rd	8-10 mm	8-10 mm	8-10 mm	8-10 mm
Standard	EN 62561-1	EN 62561-1	EN 62561-1	EN 62561-1
PU	50 pc(s)	50 pc(s)	50 pc(s)	50 pc(s)

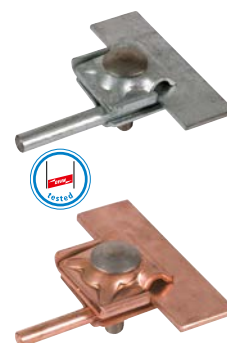

Gutter Clamps with Single-screw Technique

For connecting conductors with gutters.

With clamping piece

Part No.	339 100	339 101
Clamping range bead	16-22 mm	16-22 mm
Material of clamp	St/tZn	Al
Clamping range Rd	8-10 mm	8-10 mm
Width	40 mm	40 mm
Standard	EN 62561-1	EN 62561-1
PU	25 pc(s)	1 pc(s)



With double clamping piece

Part No.	339 110	339 111
Clamping range bead	16-22 mm	16-22 mm
Material of clamp	St/tZn	Al
Clamping range Rd	8-10 mm	8-10 mm
Width	40 mm	40 mm
Standard	EN 62561-1	EN 62561-1
PU	25 pc(s)	25 pc(s)



Gutter Clamps

For connecting conductors to gutters.

With clamping piece

Longitudinal or cross conductor routing.



Part No.	339 060	339 061	339 067	339 069
Clamping range bead	16-22 mm	16-22 mm	16-22 mm	16-22 mm
Material of gutter clamp	St/tZn	Al	Cu	StSt
Clamping range Rd	6-10 mm	6-10 mm	6-10 mm	6-10 mm
Material of conductor clamp	St/tZn	Al	Cu	StSt
Width / material thickness	40 mm	40 / 3 mm	40 / 2 mm	40 / 2 mm
Material of screw	St/tZn	StSt	StSt	StSt
Standard	EN 62561-1	EN 62561-1	EN 62561-1	EN 62561-1
PU	25 pc(s)	25 pc(s)	25 pc(s)	25 pc(s)

With double clamp

Longitudinal or cross conductor routing.

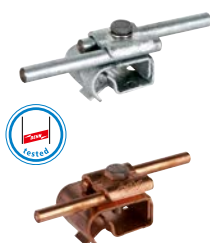

Part No.	339 050	339 051	339 057	339 059
Clamping range bead	16-22 mm	16-22 mm	16-22 mm	16-22 mm
Material of gutter clamp	St/tZn	Al	Cu	StSt
Clamping range Rd	8-10 mm	8-10 mm	8-10 mm	8-10 mm
Material of conductor clamp	St/tZn	StSt	Cu	StSt
Width / material thickness	40 / 2 mm	40 / 3 mm	40 / 2 mm	40 / 2 mm
Material of screw	St/tZn	StSt	StSt	StSt
Standard	EN 62561-1	EN 62561-1	EN 62561-1	EN 62561-1
PU	25 pc(s)	25 pc(s)	25 pc(s)	25 pc(s)

Bimetallic, for gutters (Cu), with clamping piece (St/tZn) and intermediate plate (Cupal)

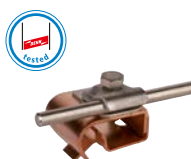

Part No.	339 167
Clamping range bead	16-22 mm
Material of gutter clamp	Cu / St/tZn
Clamping range Rd	6-10 mm
Material of screw	StSt
Standard	EN 62561-1
PU	1 pc(s)

Bimetallic, for gutters (Cu), with double clamp (St/tZn) and intermediate plate (Cupal)



Part No.	339 157
Clamping range bead	16-22 mm
Material of gutter clamp	Cu / St/tZn
Clamping range Rd	8-10 mm
Material of screw	StSt
Standard	EN 62561-1
PU	25 pc(s)

With two-screw clamp, width 40 mm

Longitudinal conductor routing.



Part No.	338 000	338 001	338 007	338 009
Clamping range bead	13-25 mm	13-25 mm	13-25 mm	13-25 mm
Material of gutter clamp	St/tZn	Al	Cu	StSt
Clamping range Rd	7-10 mm	7-10 mm	7-10 mm	7-10 mm
Material of conductor clamp	St/tZn	Al	Cu	StSt
Width / material thickness	40 / 3 mm	40 / 3 mm	40 / 3 mm	40 / 2,5 mm
Material of screw	StSt	StSt	StSt	StSt
Standard	EN 62561-1	EN 62561-1	EN 62561-1	EN 62561-1
PU	25 pc(s)	25 pc(s)	25 pc(s)	25 pc(s)

Clamps, Connectors

With two-screw clamp, width 60 mm

Longitudinal conductor routing.

Part No.	339 010
Clamping range bead	13-25 mm
Material of gutter clamp	St/tZn
Clamping range Rd	7-10 mm
Material of conductor clamp	St/tZn
Width / material thickness	60 / 2.5 mm
Material of screw	StSt
Standard	EN 62561-1
PU	25 pc(s)

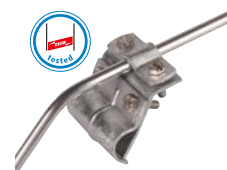

Snow Guard Clamps

For connecting conductors to snow guards, longitudinal connection with two-screw clamp.

For conductors Rd 7-10 mm.

Part No.	343 000	343 007
Clamping range	3-13 mm	3-13 mm
Material of clamp	St/tZn	Cu
Width	90 mm	90 mm
Clamping range Rd	7-10 mm	7-10 mm
Standard	EN 62561-1	EN 62561-1
PU	25 pc(s)	1 pc(s)

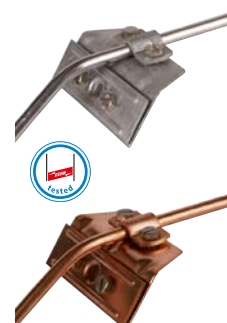

Connection Brackets

For connecting metal cladding using blind rivets or screws.

With square hole

Dimensions 11 x 11 mm (e.g. for M10 KS connector), longitudinal or cross connection.

Part No.	377 005	377 017	377 009
Material of bracket	Al	Cu	StSt
Fixing	[4x] Ø5.2 / [2x] Ø6.5 mm	[4x] Ø5.2 / [2x] Ø6.5 mm	[4x] Ø5.2 / [2x] Ø6.5 mm
Standard	EN 62561-1	EN 62561-1	EN 62561-1
PU	50 pc(s)	50 pc(s)	50 pc(s)

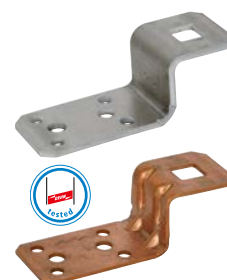

With clamping piece

Longitudinal or cross connection.

Part No.	377 100
Material of bracket	Al
Fixing	[4x] Ø5.2 / [2x] Ø6.5 mm
Material of clamping piece	St/tZn
Clamping range Rd	6-10 mm
Standard	EN 62561-1
PU	50 pc(s)



With double clamp

Longitudinal or cross connection.

Part No.	377 200
Material of bracket	Al
Fixing	[4x] Ø5.2 / [2x] Ø6.5 mm
Material of double clamp	Al
Clamping range Rd	8-10 mm
Standard	EN 62561-1
PU	50 pc(s)

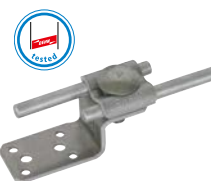

Clamping Shoes

For connecting conductors to structural parts.

With hole



Part No.	345 008	345 010
Clamping range Rd	8 mm	10 mm
Material	St/tZn	St/tZn
Fixing hole Ø	11 mm	11 mm
PU	100 pc(s)	100 pc(s)

With screws

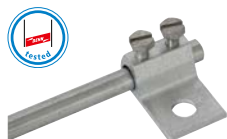

Part No.	347 205
Clamping range Rd	7-10 mm
Material	Al
Fixing hole Ø	10.5 mm
Standard	EN 62561-1
PU	100 pc(s)

Clamping Piece

For connecting flat material to structural parts or, for example, connection clamps for steel girders (without a hole in the flat strip).

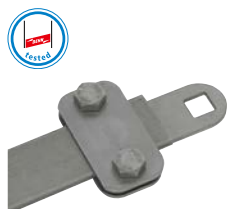

Part No.	380 129
Clamping range Fl	up to 30 x 4 mm
Material	StSt
Fixing	square hole 11 x 11 mm
Standard	EN 62561-1
PU	50 pc(s)

FS Clamps (Air-termination Rod Clamps)

For connecting air-termination rods/tips to one or two conductors.

Connection of two conductors improves the lightning current distribution and thus reduces the separation distance.

For air-termination tip 10 mm

With truss head screw, plate, nut and double conductor clamp.

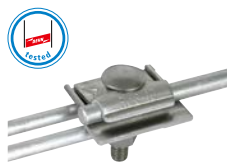

Part No.	380 110
Material of clamp	Al
Clamping range of air-termination tip	8-10 mm
Clamping range Rd	2x 8-10 mm
Material of plate	St/tZn
Standard	EN 62561-1
PU	50 pc(s)

For air-termination rod 16 mm

With truss head screw, plate, nut and double conductor holder.



Part No.	380 116
Material of clamp	Al
Clamping range of air-termination rod	16 mm
Clamping range Rd	2x 8-10 mm
Material of plate	St/tZn
Standard	EN 62561-1
PU	50 pc(s)

Rod Clamps

For connecting air-termination rods to conductors, for longitudinal connection of all conductor materials.
Cross connection (cross arrangement) only St/tZn and StSt.

Part No.	380 020	380 029
Material of clamp	St/tZn	StSt
Clamping range Rd / Rd	8-10 / 16 mm	8-10 / 16 mm
Standard	EN 62561-1	EN 62561-1
PU	50 pc(s)	50 pc(s)



Connecting Sleeve for Air-Termination Rods

With embossings (stop) for connecting longer air-termination rods (transport length).
When using the connecting sleeve, the air-termination rod must be additionally fixed above the sleeve.

Part No.	385 216
Material	Al
Clamping range Rd / Rd	16 / 16 mm
Screw	M8 x 12 mm
Material of screw	StSt
Outside diameter Ø	28 mm
Standard	EN 62561-1
PU	10 pc(s)



MV Clamps for Air-Termination Rods

Multi-purpose connecting clamp for universal use as a cross clamp, T clamp and parallel clamp; two-piece.

With hexagon screw, spring washer and thread in the base part

Part No.	392 050	392 059
Material of clamp	St/tZn	StSt
Clamping range Rd	8-10 / 16 mm	8-10 / 16 mm
Standard	EN 62561-1	EN 62561-1
PU	50 pc(s)	50 pc(s)



With truss head screw and anti-rotation protection

Part No.	392 060	392 069
Material of clamp	St/tZn	StSt
Clamping range Rd	8-10 / 16 mm	8-10 / 16 mm
Standard	EN 62561-1	EN 62561-1
PU	50 pc(s)	50 pc(s)



Cupal Sleeves

For corrosion-resistant connection of steel or aluminium with copper.

Pushed onto cut conductors

Note: Rd 8 mm = 50 mm²

General technical data:

Material thickness	1.0 mm
--------------------	--------



Part No.	562 250	562 035	562 050
Material outside	Al	Al	Al
Material inside	Cu	Cu	Cu
Cross-section	25 mm ²	35 mm ²	50 mm ²
Length	29 mm	32 mm	40 mm
Inside diameter Ø	6.3 mm	7.5 mm	8.2 mm
Outside diameter Ø	8.3 mm	9.5 mm	10.0 mm
PU	100 pc(s)	100 pc(s)	100 pc(s)

Part No.	562 135	562 150
Material outside	Cu	Cu
Material inside	Al	Al
Cross-section	35 mm ²	50 mm ²
Length	32 mm	40 mm
Inside diameter Ø	7.5 mm	8.2 mm
Outside diameter Ø	9.5 mm	10.0 mm
PU	100 pc(s)	100 pc(s)

Attached to uncut conductors

Note: Rd 8 mm = 50 mm²



Part No.	562 001	562 101
Material outside	Al	Cu
Material inside	Cu	Al
Cross-section	50 mm ²	50 mm ²
Length	60 mm	60 mm
Inside diameter Ø	8.5 mm	8.5 mm
Outside diameter Ø	9.5 mm	9.5 mm
Material thickness	0.5 mm	0.5 mm
PU	100 pc(s)	100 pc(s)

Cupal Sheets

Metal strips for corrosion-resistant connection of steel or aluminium with copper.



Part No.	562 440	562 460
Material	Al / Cu	Al / Cu
Dimensions	500 x 40 x 0.5 mm	500 x 60 x 0.5 mm
PU	1 pc(s)	1 pc(s)

UNI Disconnecting Clamps

For connecting down conductors with earth entry rods or for connecting conductors made of different materials.

With intermediate plate for two round conductors



Part No.	459 129	459 127
Material	StSt	Cu
Clamping range Rd / Rd	8-10 / 8-10 mm	8-10 / 8-10 mm
Distance between screws	40 mm	40 mm
Standard	EN 62561-1	EN 62561-1
PU	50 pc(s)	1 pc(s)

Bimetallic, for two round conductors (Cu and St/tZn or StSt (V4A))

Part No.	460 517
Material	Cu / St/tZn
Clamping range Rd / Rd	8-10 / 8-10 mm
Distance between screws	40 mm
Standard	EN 62561-1
PU	1 pc(s)



With intermediate plate for a round and a flat conductor

Part No.	459 139
Material	StSt
Clamping range Rd / Fl	8-10 / 30 mm
Distance between screws	40 mm
Standard	EN 62561-1
PU	50 pc(s)



Bimetallic, for a round Cu conductor and a flat St/tZn or StSt (V4A) conductor

Part No.	460 557
Material	Cu / St/tZn
Clamping range Rd / Fl	8-10 / 30 mm
Distance between screws	40 mm
Standard	EN 62561-1
PU	1 pc(s)



With intermediate plate for earth entry rods

Part No.	459 119
Material	StSt
Clamping range Rd / Rd	8-10 / 16 mm
Distance between screws	40 mm
Standard	EN 62561-1
PU	50 pc(s)



Bimetallic, for a round Cu conductor and a St/tZn or StSt (V4A) earth entry rod

Part No.	460 507
Material	Cu / St/tZn
Clamping range Rd / Rd	8-10 / 16 mm
Distance between screws	40 mm
Standard	EN 62561-1
PU	1 pc(s)



With intermediate plate for two round conductors, narrow design

Part No.	459 003
Material	St/tZn
Clamping range Rd / Rd	7-10 / 7-10 mm
Distance between screws	30 mm
Standard	EN 62561-1
PU	50 pc(s)



With intermediate plate for earth entry rods, narrow design

Part No.	459 000
Material	St/tZn
Clamping range Rd / Rd	7-10 / 16 mm
Distance between screws	30 mm
Standard	EN 62561-1
PU	50 pc(s)





With intermediate plate for an earth entry rod and a flat conductor

Part No.	459 159	
Material	StSt	
Clamping range Rd / Fl	16 / 30 mm	
Distance between screws	40 mm	
Standard	EN 62561-1	
PU	50 pc(s)	



Without intermediate plate for two round conductors

Part No.	459 029	459 020
Material	StSt	St/tZn
Clamping range Rd / Rd	8-10 / 8-10 mm	8-10 / 8-10 mm
Distance between screws	40 mm	40 mm
Standard	EN 62561-1	EN 62561-1
PU	50 pc(s)	50 pc(s)



Without intermediate plate for a round and a flat conductor

Part No.	459 039	459 030
Material	StSt	St/tZn
Clamping range Rd / Fl	8-10 / 30 mm	8-10 / 30 mm
Distance between screws	40 mm	40 mm
Standard	EN 62561-1	EN 62561-1
PU	50 pc(s)	50 pc(s)



Without intermediate plate for earth entry rods

Part No.	459 019	459 010
Material	StSt	St/tZn
Clamping range Rd / Rd	8-10 / 16 mm	8-10 / 16 mm
Distance between screws	40 mm	40 mm
Standard	EN 62561-1	EN 62561-1
PU	50 pc(s)	1 pc(s)

Disconnecting Clamp – Austrian Standard

With connecting screw, for round conductors.



Part No.	460 213	
Material	ZDC	
Clamping range Rd / Rd	7-10 / 7-10 mm	
Standard	EN 62561-1	
PU	50 pc(s)	

Connecting / Disconnecting Clamps

Two-piece or three-piece connection system with thread in the base part.



Two-piece, for a round and a flat conductor

Part No.	454 100	454 107
Material	St/tZn	Cu
Clamping range Rd / Fl	7-10 / 30-40 mm	7-10 / 30-40 mm
Standard	EN 62561-1	EN 62561-1
PU	25 pc(s)	25 pc(s)

Clamps, Connectors

Three-piece, (with intermediate plate) for a round and a flat conductor

Part No.	454 000
Material	St/tZn
Clamping range Rd / Fl	5-10 / 30-40 mm
Standard	EN 62561-1
PU	25 pc(s)



Two-piece, for two flat conductors

Part No.	455 000
Material	MCl/tZn
Clamping range Fl / Fl	30 / 30 mm
Standard	EN 62561-1
PU	1 pc(s)



Disconnecting Sleeves

For connecting down conductors with earth entry rods.

Open design for earth entry rods

Part No.	450 000	450 007
Material	ZDC	Gunmetal
Clamping range Rd / Rd	7-10 / 16 mm	7-10 / 16 mm
Standard	EN 62561-1	EN 62561-1
PU	50 pc(s)	1 pc(s)



Open design for earth entry rods

Part No.	450 001
Material	Al
Clamping range Rd / Rd	8-10 / 16 mm
Standard	EN 62561-1
PU	50 pc(s)



Closed design for earth entry rods

Part No.	450 011
Material	ZDC
Clamping range Rd / Rd	7-10 / 16 mm
Standard	EN 62561-1
PU	50 pc(s)



Open design for wires

Part No.	450 101
Material	Al
Clamping range Rd / Rd	8-10 / 8 mm
Standard	EN 62561-1
PU	50 pc(s)



Bimetallic Disconnecting Clamp with Shield

Bimetallic version for connecting conductors made of different materials.

Part No.	460 147
Material	Cu / St/tZn
Clamping range Rd / Fl	6-10 / 30-40 mm
Shield	plastic grey ●
Standard	EN 62561-1
PU	1 pc(s)





Connecting Components 200 kA (10/350 μs)

For use in class of LPS I and II (LPL I, II).
Clamps are tested with a 200 kA (10/350 μs) lightning impulse current, based on EN 62561-1.

UNI disconnecting clamp for two round conductors



Part No.	459 200
Material	StSt
Clamping range Rd / Rd	10 / 10 mm
Clamping range Rd / FI	10 / 30 mm
Lightning current carrying capability (10/350 μs)	200 kA
Standard	based on EN 62561-1
PU	1 pc(s)

UNI disconnecting clamp for earth entry rods



Part No.	459 219
Material	StSt
Clamping range Rd / Rd	8-10 / 16 mm
Lightning current carrying capability (10/350 μs)	200 kA
Standard	based on EN 62561-1
PU	1 pc(s)

Clamping piece



Part No.	380 209
Material	StSt
Clamping range FI	30 x 4 mm
Lightning current carrying capability (10/350 μs)	200 kA
Standard	based on EN 62561-1
PU	1 pc(s)

KS connector



Part No.	301 209
Material	StSt
Clamping range Rd	10 mm
Lightning current carrying capability (10/350 μs)	200 kA
Standard	based on EN 62561-1
PU	1 pc(s)

MV clamp for round conductors



Part No.	390 209
Material	StSt
Clamping range Rd / Rd	8-10 mm
Lightning current carrying capability (10/350 μs)	200 kA
Standard	based on EN 62561-1
PU	1 pc(s)



MV clamp for air-termination rods



Part No.	392 209
Material	StSt
Clamping range Rd / Rd	8-10 / 16 mm
Lightning current carrying capability (10/350 μs)	200 kA
Standard	based on EN 62561-1
PU	1 pc(s)

Air-Termination Rods / Tips

The table below / max. gust wind speed must be taken into account when installing air-termination rods in concrete bases.
The table applies to conventional air-termination rod materials (Al, St/tZn, Cu and StSt).

Height	Concrete Bases 1x 8.5 kg Part No. 102 075	Concrete Bases 1x 17 kg Part No. 102 010	Concrete Bases 2x 17 kg Part No. 102 010
			
1.0 m (Ø10 mm)	135 km/h	—	—
1.5 m (Ø16/10 mm)	—	150 km/h	185 km/h
2.0 m (Ø16/10 mm)	—	105 km/h	155 km/h
2.5 m (Ø16/10 mm)	—	—	120 km/h

For protecting roof-mounted structures, chimneys, etc., also for erection with concrete base.
Additional fasteners, e.g. DEHNiso spacers, are necessary depending on the gust wind speed.

Note: Permissible roof loads have to be considered and checked with the constructor where required.

Diameter 10 mm, chamfered

Especially for concrete base (8.5 kg) with fixing wedge (Part No. 102 075) or for fixing using conductor holders.

Part No.	101 000	101 009	101 007
Total length	1000 mm	1000 mm	1000 mm
Material	Al	StSt	Cu
Diameter Ø	10 mm	10 mm	10 mm
Standard	EN 62561-2	EN 62561-2	EN 62561-2
PU	20 pc(s)	20 pc(s)	20 pc(s)

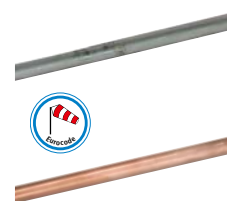

Diameter 16 mm, chamfered

General technical data:				
Diameter Ø	16 mm			
Standard	EN 62561-2			
Part No.	104 150	104 200	104 250	104 300
Total length	1500 mm	2000 mm	2500 mm	3000 mm
Material	AlMgSi	AlMgSi	AlMgSi	AlMgSi
PU	10 pc(s)	10 pc(s)	10 pc(s)	10 pc(s)
Part No.	483 100	483 125	483 150	483 200
Total length	1000 mm	1250 mm	1500 mm	2000 mm
Material	St/tZn	St/tZn	St/tZn	St/tZn
PU	10 pc(s)	10 pc(s)	10 pc(s)	10 pc(s)



With tapering, chamfered

Length of tapering 1000 mm.

General technical data:				
Material	AlMgSi			
Diameter Ø	16 / 10 mm			
Type	chamfered			
Standard	EN 62561-2			
Part No.	103 210	103 220	103 230	103 240
Total length	1500 mm	2000 mm	2500 mm	3000 mm
PU	10 pc(s)	10 pc(s)	10 pc(s)	10 pc(s)
Part No.	103 250	103 260	103 280	
Total length	3500 mm	4000 mm	5000 mm	
PU	10 pc(s)	10 pc(s)	10 pc(s)	



With tapering, M16 thread

Length of tapering 1000 mm.



General technical data:			
Material	AlMgSi		
Diameter Ø	16 / 10 mm		
Type	M16		
Standard	EN 62561-2		
Part No.	103 211	103 221	103 231
Total length	1500 mm	2000 mm	2500 mm
PU	10 pc(s)	10 pc(s)	10 pc(s)
Part No.	103 241	103 251	103 261
Total length	3000 mm	3500 mm	4000 mm
PU	10 pc(s)	10 pc(s)	10 pc(s)

Tubular air-termination rods with tapering 16 / 10 mm

Light design; length of tapering 1000 mm.



General technical data:				
Diameter Ø	16 / 10 mm			
Standard	EN 62561-2			
Part No.	103 410	103 420	103 430	103 440
Total length	1500 mm	2000 mm	2500 mm	3000 mm
Material	AlMgSi	AlMgSi	AlMgSi	AlMgSi
PU	10 pc(s)	10 pc(s)	10 pc(s)	10 pc(s)
Part No.	103 450	103 460	103 480	103 417
Total length	3500 mm	4000 mm	5000 mm	1500 mm
Material	AlMgSi	AlMgSi	AlMgSi	Cu
PU	10 pc(s)	10 pc(s)	10 pc(s)	10 pc(s)
Part No.	103 419	103 429	103 439	103 449
Total length	1500 mm	2000 mm	2500 mm	3000 mm
Material	StSt	StSt	StSt	StSt
PU	10 pc(s)	10 pc(s)	10 pc(s)	10 pc(s)

With forged lug

And clamping screw for connecting Rd 7-10 mm.



Part No.	100 100	100 150
Total length	1000 mm	1500 mm
Material	St/tZn	St/tZn
Diameter Ø	16 mm	16 mm
Terminal clamping range	7-10 mm	7-10 mm
Standard	EN 62561-(1+2)	EN 62561-(1+2)
PU	10 pc(s)	10 pc(s)

Diameter 16 mm, cut to length on site

Part No.	104 600
Total length	6000 mm
Material	AlMgSi
Diameter Ø	16 mm
Standard	EN 62561-2
PU	1 pc(s)

Special lengths of all air-termination rods / self-supporting air-termination rods are available upon request.

Rod Holders DEHNhold

For fixing air-termination and earth entry rods, with slotted saddle clamp, fixed conductor routing.
For use with different materials, e.g. Al, StSt, St/tZn and Cu.

With female thread

Part No.	274 116
Material of conductor holder	StSt
Conductor support Rd	16 mm
Height of conductor holder	20 mm
Thread of conductor holder	M8
PU	50 pc(s)



Pre-assembled with screw, plastic base and plug

With female thread.

Part No.	274 260
Material of conductor holder	StSt
Conductor support Rd	16 mm
Height of conductor holder	20 mm
Thread of conductor holder	M8
Screw	⌀5 x 50 mm
Plastic dowel	⌀8 x 40 mm
PU	50 pc(s)



Different clamps see from page 73

Self-supporting Air-Termination Rods 2.5 to 3.5 m

With tripod for protecting roof-mounted structures, adjustable to a roof inclination up to max. 10°.

The concrete base (Part No. 102 075 or 102 010) and the base plate (Part No. 102 060 or 102 050) have to be ordered separately.

Note: Permissible roof loads have to be considered and checked with the constructor where required.

Concrete Bases	Base Plates
8.5 kg, Part No. 102 075	Part No. 102 060
17 kg, Part No. 102 010	Part No. 102 050

Part No.	105 525	105 530	105 535
Height	2500 mm	3000 mm	3500 mm
Radius	320 mm	320 mm	320 mm
Max. gust wind speed for 3 bases, 8.5 kg each	137 km/h	112 km/h	95 km/h
Space required for tripod with 3 bases, 8.5 kg each (l x w)	730 x 800 mm	730 x 800 mm	730 x 800 mm
Max. gust wind speed for 3 bases, 17 kg each	188 km/h	168 km/h	135 km/h
Space required for tripod with 3 bases, 17 kg each (l x w)	850 x 930 mm	850 x 930 mm	850 x 930 mm
Material of air-termination rod	Al	Al	Al
Material of tripod	St/tZn	St/tZn	St/tZn
Standard	EN 62561-(1+2)	EN 62561-(1+2)	EN 62561-(1+2)
PU	1 pc(s)	1 pc(s)	1 pc(s)



Special lengths of all air-termination rods / self-supporting air-termination rods are available upon request.

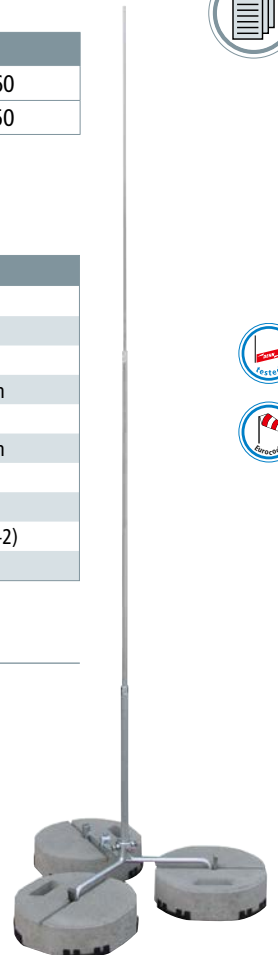

Self-supporting Air-Termination Rods 4 to 9 m



With hinged tripod for protecting larger roof-mounted structures, adjustable to the roof inclination up to max. 10°. The stackable concrete base (Part No. 102 010) and the base plate (Part No. 102 050) have to be ordered separately.

Note: Permissible roof loads have to be considered and checked with the constructor where required.

Height up to 5.5 m

Part No.	105 400	105 450	105 500	105 550
Height	4000 mm	4500 mm	5000 mm	5500 mm
Radius	560 mm	560 mm	560 mm	560 mm
Max. gust wind speed for 3 bases, 17 kg each	140 km/h	124 km/h	103 km/h	94 km/h
Max. gust wind speed for 6 bases, 17 kg each	186 km/h	167 km/h	137 km/h	127 km/h
Max. gust wind speed for 9 bases, 17 kg each	—	188 km/h	165 km/h	154 km/h
Space required for tripod	1210 x 1340 mm	1210 x 1340 mm	1210 x 1340 mm	1210 x 1340 mm
Material of tripod	St/tZn	St/tZn	St/tZn	St/tZn
Material of air-termination rod	Al	Al	Al	Al
Standard	EN 62561-(1+2)	EN 62561-(1+2)	EN 62561-(1+2)	EN 62561-(1+2)
PU	1 pc(s)	1 pc(s)	1 pc(s)	1 pc(s)



Height up to 9 m with adjustable StSt braces Ø10 mm

General technical data:	
Radius	1435 mm
Space required for tripod	2530 x 2850 mm
Material of tripod	St/tZn
Material of air-termination rod	Al
Standard	EN 62561-(1+2)

Part No.	105 600	105 650	105 700	105 750
Height	6000 mm	6500 mm	7000 mm	7500 mm
Max. gust wind speed for 3 bases, 17 kg each	115 km/h	109 km/h	97 km/h	93 km/h
Max. gust wind speed for 6 bases, 17 kg each	146 km/h	140 km/h	126 km/h	120 km/h
Max. gust wind speed for 9 bases, 17 kg each	175 km/h	167 km/h	149 km/h	144 km/h
Max. gust wind speed for 12 bases, 17 kg each	188 km/h	189 km/h	168 km/h	163 km/h
PU	1 pc(s)	1 pc(s)	1 pc(s)	1 pc(s)

Part No.	105 800	105 850	105 900
Height	8000 mm	8500 mm	9000 mm
Max. gust wind speed for 3 bases, 17 kg each	—	—	—
Max. gust wind speed for 6 bases, 17 kg each	111 km/h	106 km/h	106 km/h
Max. gust wind speed for 9 bases, 17 kg each	131 km/h	126 km/h	125 km/h
Max. gust wind speed for 12 bases, 17 kg each	147 km/h	143 km/h	142 km/h
PU	1 pc(s)	1 pc(s)	1 pc(s)

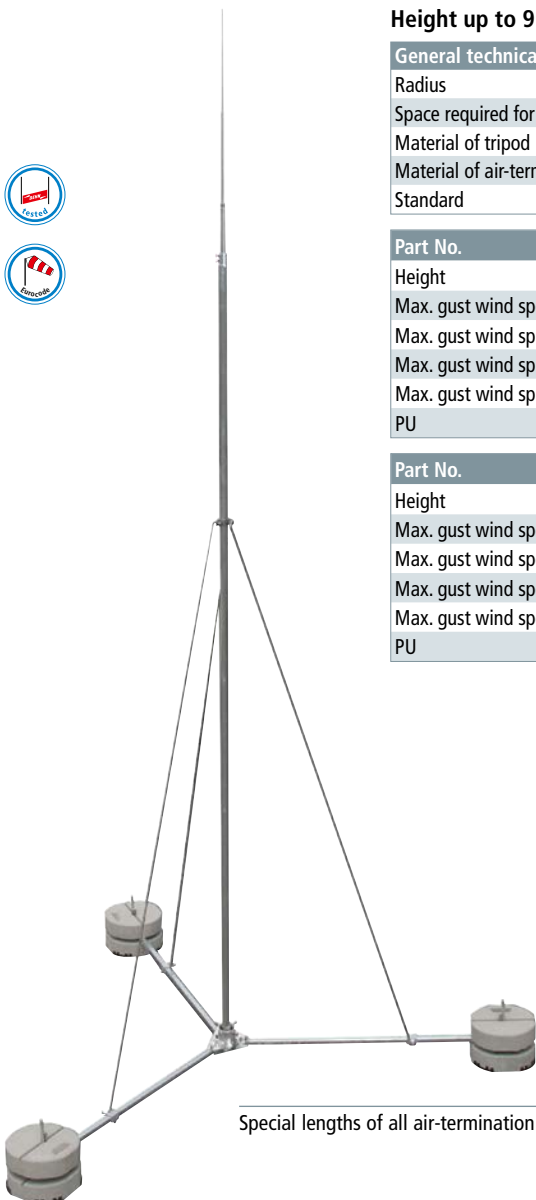

Special lengths of all air-termination rods / self-supporting air-termination rods are available upon request.

Self-supporting Air-Termination Rods 10 and 11 m



With hinged six-legged stand for protecting larger roof-mounted structures or for erection on compacted ground without foundation works, adjustable to a roof inclination up to max. 10°. The stackable concrete base (Part No. 102 010) and the base plate (Part No. 102 050) have to be ordered separately.

Note: Permissible roof loads have to be considered and checked with the constructor where required.

Free height 10 m

Part No.	105 910
Height	10000 mm
Radius	1200 mm
Max. gust wind speed for 12 bases, 17 kg each	129 km/h
Max. gust wind speed for 18 bases, 17 kg each	152 km/h
Space required for six-legged stand	2900 x 2560 mm
Material of six-legged stand	St/tZn
Material of air-termination mast/air-termination rod	Al
Standard	EN 62561-(1+2)
Surface load with 12 bases, 17 kg each	268 kg
Surface load with 18 bases, 17 kg each	370 kg
PU	1 pc(s)

Free height 11 m

Part No.	105 911
Height	11000 mm
Radius	1200 mm
Max. gust wind speed for 12 bases, 17 kg each	121 km/h
Max. gust wind speed for 18 bases, 17 kg each	141 km/h
Space required for six-legged stand	2900 x 2560 mm
Material of six-legged stand	St/tZn
Material of air-termination mast/air-termination rod	Al
Standard	EN 62561-(1+2)
Surface load with 12 bases, 17 kg each	269 kg
Surface load with 18 bases, 17 kg each	371 kg
PU	1 pc(s)

Special lengths of all air-termination rods / self-supporting air-termination rods are available upon request.

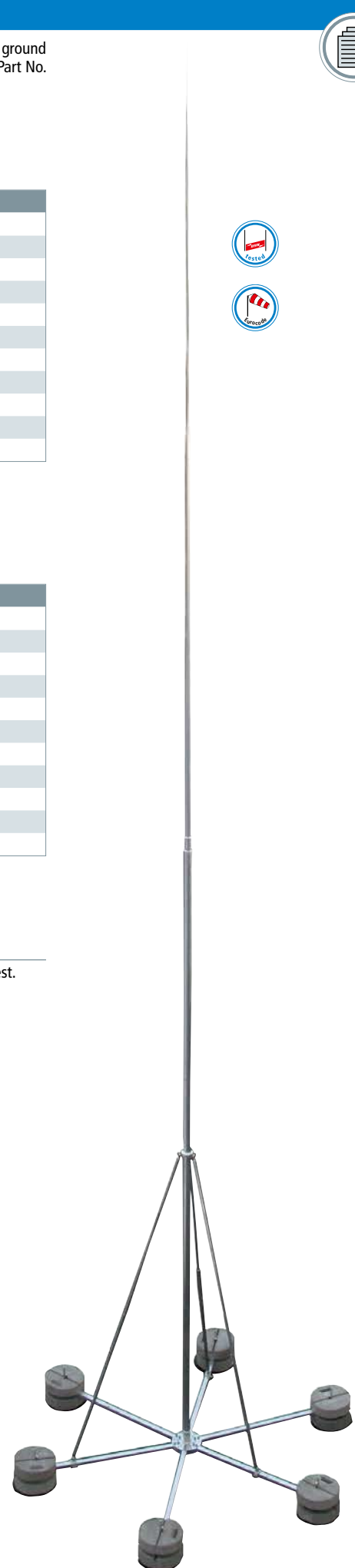



Self-supporting Air-Termination Rods 12 to 14 m

With hinged tripod for protecting larger roof-mounted structures or for erection on compacted ground without foundation works. Adjustable to a roof inclination of max. 5°.

The stackable concrete block (Part No. 102 010) and the base plate (Part No. 102 050) have to be ordered separately.

Note: Permissible roof loads have to be considered and checked with the constructor where required.



Free height 12 m

Part No.	105 922
Height	12000 mm
Radius	3000 mm
Max. gust wind speed for 18 bases, 17 kg each	134 km/h
Max. gust wind speed for 21 bases, 17 kg each	159 km/h
Max. gust wind speed for 24 bases, 17 kg each	175 km/h
Space required for tripod	4920 x 5640 mm
Material of tripod	St/tZn
Material of air-termination mast /air-termination rod	Al
Standard	EN 62561-(1+2)
Surface load with 18 bases, 17 kg each	approx. 420 kg
Surface load with 21 bases, 17 kg each	approx. 475 kg
Surface load with 24 bases, 17 kg each	approx. 525 kg
PU	1 pc(s)

Free height 13 m

Part No.	105 923
Height	13000 mm
Radius	3000 mm
Max. gust wind speed for 18 bases, 17 kg each	130 km/h
Max. gust wind speed for 21 bases, 17 kg each	150 km/h
Max. gust wind speed for 24 bases, 17 kg each	162 km/h
Space required for tripod	4920 x 5640 mm
Material of tripod	St/tZn
Material of air-termination mast /air-termination rod	Al
Standard	EN 62561-(1+2)
Surface load with 18 bases, 17 kg each	approx. 421 kg
Surface load with 21 bases, 17 kg each	approx. 476 kg
Surface load with 24 bases, 17 kg each	approx. 526 kg
PU	1 pc(s)

Free height 14 m

Part No.	105 924
Height	14000 mm
Radius	3000 mm
Max. gust wind speed for 18 bases, 17 kg each	121 km/h
Max. gust wind speed for 21 bases, 17 kg each	135 km/h
Max. gust wind speed for 24 bases, 17 kg each	139 km/h
Space required for tripod	4920 x 5640 mm
Material of tripod	St/tZn
Material of air-termination mast /air-termination rod	Al
Standard	EN 62561-(1+2)
Surface load with 18 bases, 17 kg each	approx. 430 kg
Surface load with 21 bases, 17 kg each	approx. 481 kg
Surface load with 24 bases, 17 kg each	approx. 532 kg
PU	1 pc(s)

Special lengths of all air-termination rods / self-supporting air-termination rods are available upon request.

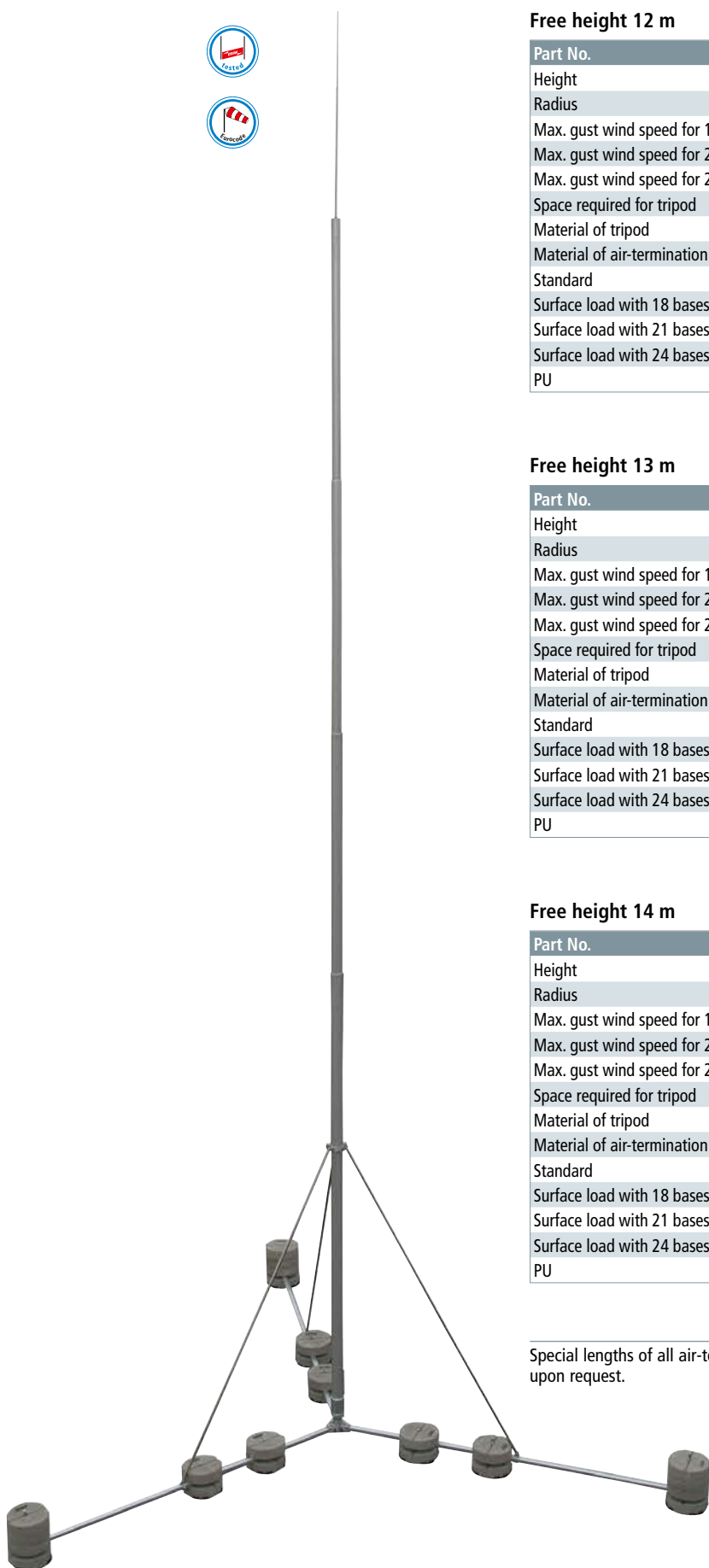

Air-Termination Rods D40

For fixing on, e.g., walls or other constructions.

The maximum free length refers to the distance between the rod tip and the upper support (fixing point).

For reasons of stability, the centre holder (3 fixing points) should be mounted directly below the upper holder. The distance must not exceed 15 cm. The lower holder (fixing point) has to be installed at a height of ≤ 15 cm at the end of the air-termination rod.

Al

General technical data:				
Material of air-termination rod	Al			
Standard	EN 62561-(1+2)			
Part No.	105 170	105 175	105 171	105 176
Total length	4000 mm	4500 mm	5000 mm	5500 mm
Max. free length with air-termination rod	3500 mm	4000 mm	4000 mm	4500 mm
Clamping length	500 mm	500 mm	1000 mm	1000 mm
Number of fixings	2	2	2	2
Max. gust wind speed	186 km/h	186 km/h	186 km/h	187 km/h
PU	1 pc(s)	1 pc(s)	1 pc(s)	1 pc(s)
Part No.	105 172	105 177	105 173	
Total length	6000 mm	6500 mm	7000 mm	
Max. free length with air-termination rod	4500 mm	5000 mm	5500 mm	
Clamping length	1500 mm	1500 mm	1500 mm	
Number of fixings	3	3	3	
Max. gust wind speed	187 km/h	184 km/h	156 km/h	
PU	1 pc(s)	1 pc(s)	1 pc(s)	
Part No.	105 178	105 174	105 179	
Total length	7500 mm	8000 mm	8500 mm	
Max. free length with air-termination rod	5500 mm	5500 mm	5500 mm	
Clamping length	2000 mm	2500 mm	3000 mm	
Number of fixings	3	3	3	
Max. gust wind speed	161 km/h	156 km/h	161 km/h	
PU	1 pc(s)	1 pc(s)	1 pc(s)	



StSt

General technical data:				
Material of air-termination rod	StSt			
Standard	EN 62561-(1+2)			
Part No.	105 190	105 195	105 191	105 196
Total length	4000 mm	4500 mm	5000 mm	5500 mm
Max. free length with air-termination rod	3500 mm	4000 mm	4000 mm	4500 mm
Clamping length	500 mm	500 mm	1000 mm	1000 mm
Number of fixings	2	2	2	2
Max. gust wind speed	195 km/h	194 km/h	193 km/h	194 km/h
PU	1 pc(s)	1 pc(s)	1 pc(s)	1 pc(s)
Part No.	105 192	105 197	105 193	
Total length	6000 mm	6500 mm	7000 mm	
Max. free length with air-termination rod	4500 mm	5000 mm	5500 mm	
Clamping length	1500 mm	1500 mm	1500 mm	
Number of fixings	3	3	3	
Max. gust wind speed	193 km/h	192 km/h	165 km/h	
PU	1 pc(s)	1 pc(s)	1 pc(s)	
Part No.	105 198	105 194	105 199	
Total length	7500 mm	8000 mm	8500 mm	
Max. free length with air-termination rod	5500 mm	5500 mm	5500 mm	
Clamping length	2000 mm	2500 mm	3000 mm	
Number of fixings	3	3	3	
Max. gust wind speed	168 km/h	159 km/h	163 km/h	
PU	1 pc(s)	1 pc(s)	1 pc(s)	



Shorter transport lengths (separable pipe) are available upon request.

Special lengths of all air-termination rods / self-supporting air-termination rods are available upon request.



Tripods for Air-Termination Rods D40 and Supporting Tubes GRP/Al

For erection with concrete bases (weight 17 kg).

Adjustable to a roof inclination up to max. 10°.

The air-termination rods D40 / supporting tubes or the stackable concrete base (Part No. 102 010) and the base plate (Part No. 102 050) have to be ordered separately.

Hinged design, St/tZn

For air-termination rods D40 mm or supporting tubes D50 mm, length 3200 mm (e.g. Part No. 105 440 or 105 300) without additional fixing to structural elements. Connection with double clamp for 2x Rd 8-10 mm [lightning current carrying capability 100 kA (10/350 μs)].



Part No.	105 200
Material of tripod	St/tZn
Support	Ø40 / 50 mm
Radius	560 mm
Space required for tripod	1200 x 1330 mm
Weight	9.6 kg
Standard	EN 62561-1
PU	1 pc(s)

Hinged design, StSt

For air-termination rods D40, DEHNiso Combi supporting tubes with air-termination tip or HVI Conductors installed in / on the supporting tube.



Part No.	105 290
Material of tripod	StSt
Support	Ø40 / 50 mm
Radius	590 mm
Space required for tripod	1230 x 1370 mm
Weight	8.4 kg
PU	1 pc(s)

Separable design, StSt

For air-termination rods D40, DEHNiso Combi supporting tubes with air-termination rod / tip or HVI Conductors installed in / on the supporting tube.



Part No.	105 291
Material of tripod	StSt
Support	Ø40 / 50 mm
Radius	1155 mm
Space required for tripod	2050 x 2300 mm
Weight	19 kg
PU	1 pc(s)

Concrete bases

For air-termination rods, for protecting small roof-mounted structures on flat roofs and for installing spacers from the DEHNiso spacer product line, e.g. for isolated ring conductors or for self-supporting air-termination rods in the tripod (only with a weight of 17 kg).

Note: Please contact us to find out whether the material of the roof conductor holder or base plate is compatible with the roof elements.

Weight 17 kg, with fixing wedge

Stackable, for air-termination rods Ø16 mm, chamfered, tapered, or for DEHNiso spacers Ø16 mm.



Part No.	102 010
Weight	17 kg
Support	wedge Ø16 mm
Diameter Ø	337 mm
Material	concrete (C45/55)
Material of wedge	StSt
PU	54 pc(s)

Weight 17 kg, concrete base with fixing wedge and adapted base plate

Stackable



Part No.	102 340
Weight	17 kg
Support	wedge Ø16 mm
Diameter Ø	337 mm
Material	concrete (C45/55)
Material of wedge	StSt
PU	54 pc(s)

Weight 17 kg, with threaded adapter

For air-termination rods with M16 thread.

Part No.	102 002
Weight	17 kg
Support	M16 thread
Diameter Ø	337 mm
Material	concrete (C45/55)
Material of adapter	plastic
PU	54 pc(s)



Weight 17 kg

Concrete base without wedge for the erection of tripods with threaded rods M16 (e.g. Part No. 105 390 + 105 396 ...).

Part No.	102 012
Weight	17 kg
Support	Ø16 mm
Diameter Ø	337 mm
Material	concrete (C45/55)
PU	54 pc(s)



Weight 8.5 kg, with fixing wedge

For air-termination tips Ø10 mm, length 1000 mm, or DEHNiso spacers Ø16 mm, length up to 675 mm (distance 0.8 m), or conductor holders (Part No. 253 279).

Part No.	102 075
Weight	8.5 kg
Support	wedge Ø10 / 16 mm
Diameter Ø	240 mm
Material	concrete (C45/55)
Material of wedge	StSt
PU	120 pc(s)



Weight 8.5 kg, with threaded adapter

For air-termination rods with thread and additional fixing, e.g. with DEHNiso spacers.

Part No.	102 003
Weight	8.5 kg
Support	M16 thread
Diameter Ø	240 mm
Material	concrete (C45/55)
Material of adapter	plastic
PU	120 pc(s)



Plastic base plates

To protect the roof sheeting under the concrete base.

Note: Please contact us to find out whether the material of the roof conductor holder and base plate is compatible with the roof elements.

Large

For concrete bases (Part No. 102 010, 102 002), weight 17 kg.

Part No.	102 050
Outside diameter Ø	370 mm
Inside diameter Ø	360 mm
Material	EVA
Colour	black ●
PU	1 pc(s)



Small

For concrete bases (Part No. 102 075, 102 003), weight 8.5 kg.

Part No.	102 060
Outside diameter Ø	280 mm
Inside diameter Ø	270 mm
Material	EVA
Colour	black ●
PU	1 pc(s)



Mounting Bracket for Air-Termination Systems on Metal Roofs



Mounting bracket (StSt) for installing HVI air-termination systems or air-termination rods on metal roofs: Mounting bracket for vertical mounting of air-termination systems on metal roofs with an inclination of max. 53°. For fixing air-termination rods D40 and attaching DEHNcon-H systems, e.g. Part No. 819 243 or 819 247, with conductor in the supporting tube.



Note: Mounting conditions on site must be clarified with the building constructor.



More information on max. gust wind speeds at www.dehn-international.com



Part No.	105 241
Material	StSt
Adjustment range	550-900 mm
Roof inclination	5-53°
Standard	EN 62561-1
PU	1 pc(s)

Accessories for Mounting Bracket for Air-Termination Systems on Metal Roofs

Holder for metal roofs with round standing seam

Screw with self-locking nut.



Part No.	123 040
Material of holder	StSt
Clamping range	Ø20-25 mm
Screw	⬆ M8 x 25 mm
Material of screw / nut	StSt
Standard	EN 62561-1
PU	12 pc(s)

Holder for metal roofs with clamping seam (e.g. RIB-ROOF Speed 500 from Zambelli)

Screw with self-locking nut.



Part No.	123 041
Material of the holder	StSt
Clamping range	approx. 18 / 22 mm
Screw	⬆ M8 x 25 mm
Material of the screw / nut	StSt
Standard	EN 62561-1
PU	12 pc(s)

Holder for metal roofs with standing seam

Screw with self-locking nut.



Part No.	123 042
Material of the holder	StSt
Clamping range	0.7-8 mm
Screw	⬆ M8 x 25 mm
Material of the screw / nut	StSt
Standard	EN 62561-1
PU	12 pc(s)

Holder for metal roofs for riveting or screwing

Screw with self-locking nut.

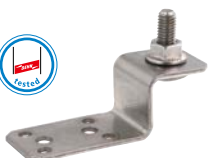

Part No.	123 043
Material of the holder	StSt
Fixing	[4x] Ø5.2 / [2x] Ø6.5 mm
Screw	⬆ M8 x 25 mm
Material of the screw / nut	StSt
Standard	EN 62561-1
PU	12 pc(s)

C mounting rail for mounting bracket for installation on metal roofs

C mounting rails with holes for fixing the mounting bracket for installation on metal roofs.

Part No.	123 050 <small>NEW</small>	123 051 <small>NEW</small>	123 052 <small>NEW</small>
Material of the rail	StSt (V4A)	StSt (V4A)	StSt (V4A)
Dimensions of the rail (l x w x h)	[2x]1000 x 41 x 41 mm	[2x]1500 x 41 x 41 mm	[2x] 2000 x 41 x 41 mm
PU	1 pc(s)	1 pc(s)	1 pc(s)



Hanger bolt for wooden substructures

Hanger bolt for fixing the mounting bracket on roofs with wooden substructures. To prevent the ingress of moisture, the hanger bolts feature a hexagon socket 5 mm and an EPDM seal membrane.

Part No.	528 820 <small>NEW</small>
Material	StSt
Thread length wood	70 mm
Metric thread length	M10 x 50 mm
Total length	185 mm
PU	1 pc(s)



Hanger bolt for metal substructures

Hanger bolt for fixing the mounting bracket on roofs with metal substructures. To prevent the ingress of moisture, the hanger bolts feature a hexagon socket 5 mm and an EPDM seal membrane.

Part No.	528 821 <small>NEW</small>
Material	StSt
Thread length steel	65 mm
Metric thread length	M10 x 50 mm
Total length	180 mm
PU	1 pc(s)



Supports for Air-Termination Rods D40 and DEHNcon-H



Wall mounting bracket for horizontal mounting, flat

Part No.	105 140
Material	StSt
Fixing	[8x] Ø5.1 / [4x] 11 x 20 mm
Distance from wall	80 mm
Clamping range for air-termination rod	40 mm
PU	1 pc(s)



Wall mounting bracket for vertical mounting

Part No.	105 342	105 348
Material	StSt	StSt
Fixing	[8x] Ø5.1 / [4x] 7 x 10 / [2x] 11 x 20 mm	[8x] Ø5.1 / [4x] 7 x 10 / [2x] 11 x 20 mm
Distance from wall	46 mm	110 mm
Clamping range for air-termination rod	40-50 mm	40-50 mm
PU	1 pc(s)	1 pc(s)





Wall mounting bracket, adjustable from 150-200 mm

For attaching supporting tubes or air-termination rods D40 / D50 with double clamp, for connecting 2x Rd 8-10 mm.

Part No.	105 344
Material	StSt
Fixing	[4x] 12 x 26 mm
Distance from wall	150-200 mm
Clamping range Rd	8-10 mm
Clamping range for air-termination rod	40-50 mm
Standard	EN 62561-1
PU	1 pc(s)

Wall mounting bracket, adjustable from 230-1300 mm



Part No.	105 347	105 343	105 349
Material	St/tZn / StSt	St/tZn / StSt	St/tZn / StSt
Fixing	[4x] 12 x 26 mm	[4x] 12 x 26 mm	[4x] 12 x 26 mm
Distance from wall	230-400 mm	400-700 mm	700-1300 mm
Clamping range for air-termination rod	40-50 mm	40-50 mm	40-50 mm
PU	1 pc(s)	1 pc(s)	1 pc(s)

Railing clamp



Part No.	105 354
Material	StSt
Clamping range Ø of pipe	48-60 mm (1 1/2 - 2")
Clamping range for air-termination rod	40-50 mm
PU	5 pc(s)

Railing clamp with spacer

With spacer for adjusting e.g. antenna holders.



Part No.	105 162
Material	StSt
Clamping range Ø of pipe	45-65 mm (1 1/2 - 2")
Clamping range for air-termination rod	40-50 mm
Length of spacer	95 mm
Standard	EN 62561-1
PU	1 pc(s)

Fixing clamp with tensioning strap

Two fixing clamps ensure mechanical stability and a lightning current carrying capability of 100 kA (10/350 µs).



Part No.	105 160
Material	StSt
Clamping range Ø of pipe	50-300 mm
Clamping range for air-termination rod	40-50 mm
Dimensions of strap (w x d)	25 x 0.3 mm
Standard	EN 62561-1
PU	1 pc(s)

Fixing clamp with tensioning strap and spacer

With additional long spacer for adjusting sector antenna holders on the mast.



Part No.	105 163
Material	StSt
Clamping range Ø of pipe	50-300 mm
Clamping range for air-termination rod	40-50 mm
Dimensions of strap (w x d)	25 x 3.0 mm
Length of spacer	95 mm
PU	1 pc(s)

Telescopic Lightning Protection Mast with Screw Foundation

Air-termination mast for protecting special facilities such as biogas plants and free field PV systems against direct lightning strikes.

The masts are erected in a screw foundation.

No digging or foundation work necessary.

The screw foundation is screwed into the natural ground and fixed in place by three earth rods $\varnothing 20$ mm, length 1500 mm (Part No. 620 151). These must be ordered separately.

The air-termination masts are designed according to Eurocode.

These calculations are based on a natural ground pressure of 0.02 kN/cm² (e.g. loamy, sandy, gravelly soil of medium density).

General technical data:			
Standard	EN 62561-(1+2)		
Part No.	103 121	103 122	103 123
Material	St/tZn / Al / StSt	St/tZn / Al	St/tZn / Al / StSt
Height above ground level	6000 mm	7000 mm	8000 mm
Max. gust wind speed	240 km/h	186 km/h	168 km/h
PU	1 pc(s)	1 pc(s)	1 pc(s)
Part No.	103 124	103 125	103 126
Material	St/tZn / Al	St/tZn / Al / StSt	St/tZn / Al
Height above ground level	9000 mm	10000 mm	11000 mm
Max. gust wind speed	149 km/h	122 km/h	114 km/h
PU	1 pc(s)	1 pc(s)	1 pc(s)

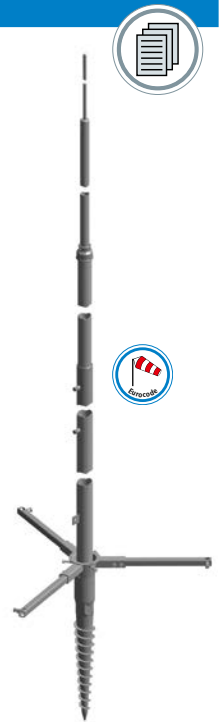

Telescopic Lightning Protection Mast for Bucket or Concrete Foundations

Air-termination mast for protecting special facilities such as biogas plants, free field PV systems, Ex systems and ammunition dumps against direct lightning strikes. The masts are erected in a bucket foundation (pre-fabricated) or an on-site concrete foundation with foundation basket (to be ordered separately). For detailed information on the plug-in system, foundation and installation, please see installation instructions No. 1729.

Advantages of the air-termination mast system:

- Excavation work can be completed in advance
- Erection in (prefabricated) bucket foundation on site with comparatively little effort, or
- Erection in on-site concrete foundations with foundation basket (concrete curing time to be observed for scheduling and erection)
- With flange plate for fast mounting
- Easily adjustable with M24 threaded bolts
- Detailed mounting instructions
- Verifiable statics (upon request)

Components:

- Air-termination rod, St/tZn, $\varnothing 42 / 20 / 10$ mm, length 2400 or 5400 mm, with M20 thread and lock nut
- Conic mast segments
- Flange plate with connection lug for earth connection hole $\varnothing 12$ mm (for round conductor $\varnothing 10$ mm, e.g. with KS connector (Part No. 301 019))

Max. transport length 6 m.

General technical data:			
Material	St/tZn		
Standard	EN 62561-(1+2)		
Part No.	103 013	103 016	103 019
Height above ground level	13350 mm	16350 mm	19350 mm
Mast segments	2	2	3
Max. gust wind speed	221 km/h	171 km/h	160 km/h
Dimensions of flange plate	400 x 400 mm	400 x 400 mm	400 x 400 mm
Flange plate	4x $\varnothing 28$ mm for 4x M24 (300 x 300 mm)	4x $\varnothing 28$ mm for 4x M24 (300 x 300 mm)	4x $\varnothing 28$ mm for 4x M24 (300 x 300 mm)
Dim. of on-site concrete foundation (l x w x h)	1400 x 1400 x 900 mm	1400 x 1400 x 900 mm	1600 x 1600 x 900 mm
Weight	approx. 228 kg	approx. 230 kg	approx. 310 kg
PU	1 pc(s)	1 pc(s)	1 pc(s)
Part No.	103 022	103 025	
Height above ground level	22350 mm	24850 mm	
Mast segments	4	5	
Max. gust wind speed	166 km/h	159 km/h	
Dimensions of flange plate	565 x 565 mm	565 x 565 mm	
Flange plate	8x $\varnothing 28$ mm for 8x M24 (490 x 490 mm)	8x $\varnothing 28$ mm for 8x M24 (490 x 490 mm)	
Dim. of on-site concrete foundation (l x w x h)	1800 x 1800 x 900 mm	2000 x 2000 x 900 mm	
Weight	approx. 450 kg	approx. 550 kg	
PU	1 pc(s)	1 pc(s)	

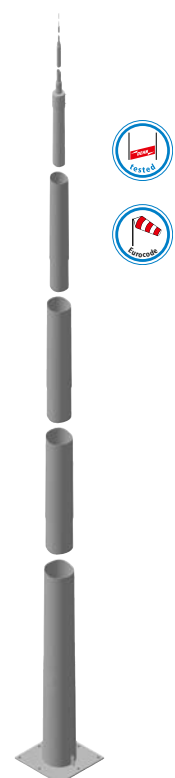



Bucket Foundations for Telescopic Lightning Protection Masts

Prefabricated element for easy erection of telescopic lightning protection masts.
No concreting on site.
For detailed information on the telescopic system, foundation and erection, please see the installation instructions.

Type KóFU I

For masts with a height above ground level from 13.35 to 19.35 m.
(Part No. 103 013 / 103 016 / 103 019)
Flange plate 400 x 400 mm.

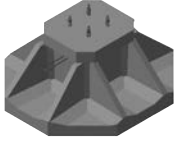

Part No.	103 030
Material	concrete (C50/60)
Dimensions	1800 x 2000 x 850 mm
Weight	approx. 2.5 t
PU	1 pc(s)

Type KóFU II

For masts with a height above ground level from 22.35 to 24.85 m.
(Part No. 103 022 or 103 025)
Flange plate 565 x 565 mm.

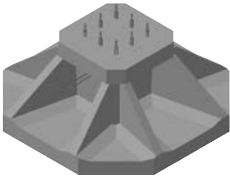

Part No.	103 031
Material	concrete (C50/60)
Dimensions	2400 x 2400 x 1010 mm
Weight	approx. 4.9 t
PU	1 pc(s)



Foundation Basket for On-site Concrete Foundations

With threaded bolts for setting in concrete, suitable for the flange plate of telescopic lightning protection masts.
For detailed information on the telescopic system, foundation and erection, see the installation instructions.

Small design

For masts with a height above ground level from 13.35 m to 19.35 m (Part No. 103 013 / 103 016 / 103 019).
Flange plate 400 x 400 mm.



Part No.	103 040
Material	steel
Dimensions	472 x 324 x 870 mm
Type of threaded bolt	4x M24 (300 x 300 mm)
PU	1 pc(s)

Large design

For masts with a height above ground level from 22.35 m to 24.85 m (Part No. 103 022 or 103 025).
Flange plate 565 x 565 mm.

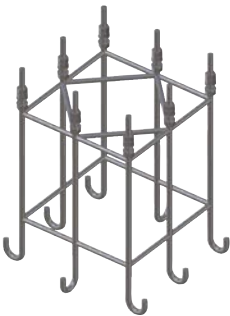

Part No.	103 041
Material	steel
Dimensions	662 x 662 x 870 mm
Type of threaded bolt	8x M24 (490 x 490 mm)
PU	1 pc(s)

Air-Termination Rods for Metal Roofs

For protecting roof-mounted structures, domelights, etc. The air-termination rod is fixed at the end of the braces (holes Ø11 mm) by means of four roof conductor holders. The roof conductor holders must be chosen according to the roof profile (e.g. round standing seam No. 223 010 or standing seam Part No. 365 059).

Height 2000 mm

With M16 threaded bolts.

Part No.	123 021
Total length (Ø16 / 10 mm)	2000 mm
Max. gust wind speed	187 km/h
Profile distance	230-520 mm
Fixing	[4x] Ø11 mm
Material of braces	StSt
Material of air-termination rod	Al
Standard	EN 62561-(1+2)
PU	1 pc(s)

Height up to 3500 mm

Adjustable to a roof inclination up to max. 10°.

Part No.	123 425	123 430	123 435
Total length (Ø22 / 16 / 10 mm)	2500 mm	3000 mm	3500 mm
Max. gust wind speed	187 km/h	168 km/h	167 km/h
Profile distance	230-520 mm	230-520 mm	230-520 mm
Fixing	[4x] Ø11 mm	[4x] Ø11 mm	[4x] Ø11 mm
Material of braces	StSt	StSt	StSt
Material of air-termination rod	Al	Al	Al / StSt
Standard	EN 62561-(1+2)	EN 62561-(1+2)	EN 62561-(1+2)
PU	1 pc(s)	1 pc(s)	1 pc(s)

Special lengths of all air-termination rods / self-supporting air-termination rods are available upon request.

Accessories for Air-Termination Rods for Metal Roofs

Holder for metal roofs with round standing seam

Screw with self-locking nut.

Part No.	123 040
Material of holder	StSt
Clamping range	Ø20-25 mm
Screw	⬆ M8 x 25 mm
Material of screw / nut	StSt
Standard	EN 62561-1
PU	12 pc(s)



Holder for metal roofs with clamping seam (e.g. RIB-ROOF Speed 500 from Zambelli)

Screw with self-locking nut.

Part No.	123 041
Material of holder	StSt
Clamping range	approx. 18 / 22 mm
Screw	⬆ M8 x 25 mm
Material of screw / nut	StSt
Standard	EN 62561-1
PU	12 pc(s)



Holder for metal roofs with standing seam

Screw with self-locking nut.



Part No.	123 042
Material of holder	StSt
Clamping range	0.7-8 mm
Screw	⬆ M8 x 25 mm
Material of screw / nut	StSt
Standard	EN 62561-1
PU	12 pc(s)

Holder for metal roofs for riveting or screwing

Screw with self-locking nut.



Part No.	123 043
Material of holder	StSt
Fixing	[4x] Ø5.2 / [2x] Ø6.5 mm
Screw	⬆ M8 x 25 mm
Material of screw / nut	StSt
Standard	EN 62561-1
PU	12 pc(s)

Air-Termination Rod for Trapezoidal Roofs



For protecting roof-mounted structures, domelights etc.

The air-termination rod is placed in the gap between the trapezoidal seams profile. The variable base frame can be adjusted to all trapezoidal profiles. The special holder for the air-termination rod can compensate roof inclinations up to 10°.



Part No.	123 032
Total length (Ø16 / 10 mm)	2000 mm
Max. gust wind speed	143 km/h
Profile distance	600-770 mm
Material of air-termination rod	Al
Material of bases	plastic
Standard	EN 62561-2
PU	1 pc(s)

Type with a length of 1500 mm (with Part No. 103 210) is available upon request.

Special lengths of all air-termination rods / self-supporting air-termination rods are available upon request.

Air-Termination Rod for Ridge and Hip Tiles



For protecting solar thermal modules, photovoltaic generators or other roof-mounted structures on steep roofs.

The clamping bracket must be adjusted to the diameter of the ridge tiles before it is used to secure the air-termination rod.

Part No.	123 109
Material of air-termination rod	Al
Length	1000 mm
Clamping range	120-240 mm
Standard	EN 62561-2
PU	1 pc(s)



Special lengths of all air-termination rods / self-supporting air-termination rods are available upon request.

Holders for Air-Termination Systems on Ridge and Hip Tiles



For air-termination rods or spacer bars with conductor holder, for protecting solar thermal modules, photovoltaic generators or other roof-mounted structures on steep roofs.

The holder is mounted using a tensioning strap. One clip is permanently fixed to one end of the tensioning strap. The holder can be adjusted to various types of ridge tiles using the adjustable clip at the other end.

Air-termination tips / rods or spacer bars have to be ordered separately.

Single design

For air-termination tips (length 1000 mm) or spacer bars (GRP, Ø10 mm).

Part No.	123 110
Clamping range Rd	10 mm
Tensioning range	120-300 mm
Material of fixing bush	StSt
Max. gust wind speed	150 km/h
PU	1 pc(s)



Double design

For air-termination rods Ø16 / 10 mm, max. length of 1.5 m, incl. clamping piece for connecting round conductors Rd 6-10 mm.

Part No.	123 116
Clamping range Rd	16 mm
Tensioning range	120-300 mm
Mounting distance	approx. 280 / 350 / 420 mm
Material of fixing bush	StSt
Max. gust wind speed	199 km/h
PU	1 pc(s)



Accessories for Holders for Air-Termination Systems on Ridge and Hip Tiles

Air-termination tips

For protecting roof-mounted structures, chimneys.

Part No.	101 000	101 009
Total length	1000 mm	1000 mm
Material	Al	StSt
Standard	EN 62561-2	EN 62561-2
Diameter Ø	10 mm	10 mm
PU	20 pc(s)	20 pc(s)



Tubular air-termination rods

For protecting roof-mounted structures.

Part No.	103 410
Total length	1500 mm
Material	AlMgSi
Diameter Ø	16 / 10 mm
Max. gust wind speed	175 km/h
PU	10 pc(s)



Spacer bar with conductor holder

For insertion into the holder for air-termination systems on ridge and hip tiles. For raised conductor routing, loose conductor routing.

Part No.	253 315	253 325
Conductor support Rd	8 mm	8 mm
Material of conductor holder	plastic	plastic
Length	280 mm	420 mm
Insulating clearance	220 mm	360 mm
Permanent temperature range	-30 °C ... +80 °C	-30 °C ... +80 °C
PU	24 pc(s)	24 pc(s)



Rod Holder for Gable Roofs

Base for fixing air-termination rods on steep roofs, with anti-rotation protection (toothed lock washer) and lock nut as well as boreholes for screwing the brace onto the roof battens. At the chimney, the air-termination rod requires additional fixing e.g. by means of DEHNiso spacer.



Part No.	223 005
Material of brace	St/tZn
Material of bolt	StSt
Length of brace	475 mm
Conductor support Rd	16 mm
PU	1 pc(s)

Pipe Clamp for Air-Termination Rods

For fixing as well as lightning current carrying contact of the air-termination rod, e.g. on metal substructures of photovoltaic (PV) installations (square hollow profile); typically installed on steel frame or reinforced concrete structures. When mounted on pipes, the pressure plate (flat plate 2x angled) has to be removed. Two pipe clamps have to be installed on each air-termination rod. The maximum free length of the respective air-termination rod according to the wind load must be considered for installation.



Part No.	540 105
Material of head / strap	StSt
Clamping range of square hollow profile	40 x 60 to 70 x 70 mm
Clamping range of pipe	50-300 mm
Connection Rd	16 mm
Dimensions of tensioning strap	1100 x 25 x 0.3 mm
Standard	EN 62561-1
PU	1 pc(s)

Angled Air-Termination Tips

For protecting, e.g. free field photovoltaic systems or carports with a PV system against direct lightning strikes. A distance of 15-20 cm between the seam clamps and the free length of 80-85 cm should be ensured. The air-termination tip is adjustable to the inclination angle of the PV system. The standard type is 55° angled which corresponds to a PV system inclination of 35°.

Air-termination tip with two seam clamps (Part No. 365 031)

Clamping range of the seam clamps 0.7-8 mm.



Part No.	101 110
Total length	1000 mm
Material	Al
Diameter Ø	10 mm
Max. gust wind speed	224 km/h
PU	1 pc(s)

Separate air-termination tip

Can be combined, e.g. with connection clamps for steel girders.



Part No.	101 010
Total length	1000 mm
Material	Al
Diameter Ø	10 mm
Max. gust wind speed	224 km/h
PU	10 pc(s)

Special lengths of all air-termination rods / self-supporting air-termination rods are available upon request.

Air-Termination Rod Adapter

For vertical positioning of air-termination rods in case of roof inclinations up to 10°. For concrete bases with fixing wedge (Part No. 102 010 or 102 340).



Part No.	106 008
Material of support	St/tZn
Clamping range	16 mm
Material of bolt	StSt
PU	1 pc(s)

Air-Termination Tips

End cap for air-termination conductors.

For steel or aluminium conductors

Part No.	110 000
Material	ZDC
Conductor Rd	7-10 mm
Length	29 mm
Outside diameter Ø	15 mm
PU	50 pc(s)



For copper conductors

Part No.	110 017
Material	Brass/gal Cu
Conductor Rd	8 mm
Length	29 mm
Outside diameter Ø	14 mm
PU	10 pc(s)



Air-Termination Stud

For installing meshed air-termination systems, for accessible flat roofs, e.g. parking decks. The air-termination stud and the conductors may either be installed in concrete or in the joints between the decks.



Part No.	108 009
Material of clamp	StSt
Material of stud	StSt
Connection Rd	8-10 mm
Standard	EN 62561-1
Installation depth	min. 70 mm
Levelling range	18 mm
PU	1 pc(s)





DEHN protects.

DEHNiso Spacers

If air-termination rods are fixed by means of spacers, the calculations are based on the **installation possibilities** below. The maximum permissible gust wind speeds are specified for the relevant products and have to be considered for selection / installation. A higher mechanical strength can be achieved by means of e.g. an angled support (two spacers arranged in a triangle) (on request).

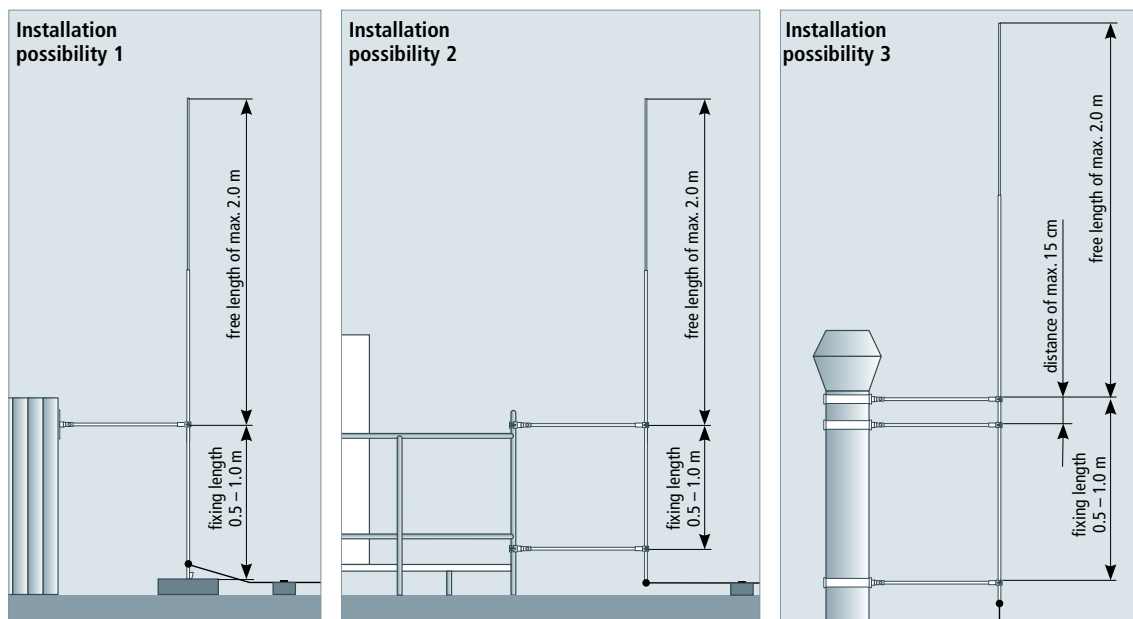

Variable holders for conductors and air-termination rods for keeping the separation distance according to IEC/EN 62305-3. Spacer bar made of glass-fibre reinforced plastic (GRP), Ø16 mm, UV-stabilised, light grey colour.

With rod holder and fixing plate

Fixed conductor routing.

Part No.	106 115	106 120	106 123
Conductor support Rd	16 mm	16 mm	16 mm
Material of conductor holder	StSt	StSt	StSt
Length	530 mm	690 mm	1030 mm
Insulating clearance	445 mm	605 mm	945 mm
Fixing	[8x] Ø5.1 / [4x] 7 x 10 / [2x] 11 x 20 mm	[8x] Ø5.1 / [4x] 7 x 10 / [2x] 11 x 20 mm	[8x] Ø5.1 / [4x] 7 x 10 / [2x] 11 x 20 mm
Permanent temperature range	-50 °C ... +100 °C	-50 °C ... +100 °C	-50 °C ... +100 °C
Max. gust wind speed installation possibility 1	130 km/h	125 km/h	120 km/h
PU	1 pc(s)	1 pc(s)	1 pc(s)



With conductor holder and fixing plate

Fixed conductor routing.

Part No.	106 090	106 100	106 105
Conductor support Rd	7-10 mm	7-10 mm	7-10 mm
Material of conductor holder	StSt	StSt	StSt
Length	530 mm	690 mm	1030 mm
Insulating clearance	445 mm	605 mm	945 mm
Fixing	[8x] Ø5.1 / [4x] 7 x 10 / [2x] 11 x 20 mm	[8x] Ø5.1 / [4x] 7 x 10 / [2x] 11 x 20 mm	[8x] Ø5.1 / [4x] 7 x 10 / [2x] 11 x 20 mm
Permanent temperature range	-50 °C ... +100 °C	-50 °C ... +100 °C	-50 °C ... +100 °C
Max. gust wind speed (holder distance 1000 mm, Al Ø8-10 mm)	224 km/h	184 km/h	137 km/h
PU	1 pc(s)	1 pc(s)	1 pc(s)



With rod holder and pipe clamp

Part No.	106 225	106 226	106 228
Conductor support Rd	16 mm	16 mm	16 mm
Material of conductor holder	StSt	StSt	StSt
Length	530 mm	690 mm	1030 mm
Insulating clearance	445 mm	605 mm	945 mm
Clamping range of pipe	40-60 mm (1 1/4-2")	40-60 mm (1 1/4-2")	40-60 mm (1 1/4-2")
Permanent temperature range	-50 °C ... +100 °C	-50 °C ... +100 °C	-50 °C ... +100 °C
Max. gust wind speed installation possibility 2	130 km/h	121 km/h	103 km/h
PU	1 pc(s)	1 pc(s)	1 pc(s)



With rod holder and pipe clamp

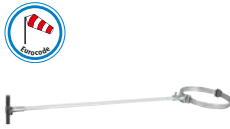

Part No.	106 245	106 246	106 248
Conductor support Rd	16 mm	16 mm	16 mm
Material of conductor holder	StSt	StSt	StSt
Length	530 mm	690 mm	1030 mm
Insulating clearance	445 mm	605 mm	945 mm
Clamping range of pipe	50-300 mm	50-300 mm	50-300 mm
Permanent temperature range	-50 °C ... +100 °C	-50 °C ... +100 °C	-50 °C ... +100 °C
Max. gust wind speed installation possibility 3	146 km/h	135 km/h	112 km/h
PU	1 pc(s)	1 pc(s)	1 pc(s)

With DEHNgrip conductor holder

For installation, e.g. in a concrete base (Part No. 102 075). Loose conductor routing.



Part No.	106 160
Conductor support Rd	8 mm
Material of conductor holder	StSt
Length	675 mm
Insulating clearance	590 mm
Permanent temperature range	-50 °C ... +100 °C
Max. gust wind speed (base 8.5 kg, holder distance 1100 mm, Al Ø8 mm)	102 km/h
Max. gust wind speed (base 17 kg, holder distance 1100 mm, Al Ø8 mm)	175 km/h
PU	1 pc(s)

With MMV clamp

For crossing points, when installed in a concrete base (Part No. 102 075), fixed conductor routing.



Part No.	106 150
Conductor support Rd	6-10 mm
Material of conductor holder	StSt
Length	675 mm
Insulating clearance	590 mm
Permanent temperature range	-50 °C ... +100 °C
Max. gust wind speed (base 8.5 kg, holder distance 1100 mm, Al Ø10 mm)	94 km/h
Max. gust wind speed (base 17 kg, holder distance 1100 mm, Al Ø10 mm)	162 km/h
PU	1 pc(s)

Versions with other spacer bar lengths are available upon request.

Accessories for DEHNiso Spacers

Spacer bar

Cut to length (variable length).



Part No.	106 125
Material	GRP
Permanent temperature range	-50 °C ... +100 °C
Colour of spacer bar	light grey (RAL 7035) ●
Diameter Ø	16 mm
Total length	3000 mm
PU	10 pc(s)

Fixing bush

Variable fixing of conductor and rod holders on a spacer bar (Ø16 mm), with M8 female thread.



Part No.	106 126
Material	ZDC
Female thread	M8
Diameter Ø	23 mm
PU	20 pc(s)

Fixing plate

Base plate for fixing the spacer or spacer bar (Ø16 mm), e.g. on structural parts.

Part No.	106 127
Material of fixing plate	StSt
Material of fixing bush	ZDC
Fixing	[8x] Ø5.1 / [4x] 7 x 10 / [2x] 11 x 20 mm
Dimensions	170 x 40 x 3 mm
PU	20 pc(s)



Conductor holder with fixing bush

For fixing conductors on the GRP bar.

Part No.	106 128
Material of conductor holder	StSt
Conductor support Rd	7-10 mm
Conductor routing	fixed
PU	20 pc(s)



Rod holder with fixing bush

For fixing air-termination rods on the GRP bar.

Part No.	106 129
Material of conductor holder	StSt
Conductor support Rd	16 mm
Conductor routing	fixed
PU	20 pc(s)



Spacers with conductor holder

For fixing conductors at different supports, fixed conductor routing.

Part No.	106 165	106 170	106 175
Conductor support Rd	7-10 mm	7-10 mm	7-10 mm
Material of conductor holder	StSt	StSt	StSt
Length	515 mm	675 mm	1015 mm
Insulating clearance	435 mm	595 mm	935 mm
Max. gust wind speed (holder spacing 1.000 mm, Al Ø10 mm)	224 km/h	184 km/h	137 km/h
PU	1 pc(s)	1 pc(s)	1 pc(s)



Spacers with rod holder

For fixing air-termination rods at different supports, fixed conductor routing.

Part No.	106 178	106 180	106 185
Conductor support Rd	16 mm	16 mm	16 mm
Material of conductor holder	StSt	StSt	StSt
Length	515 mm	675 mm	1015 mm
Insulating clearance	435 mm	595 mm	935 mm
Max. gust wind speed installation possibility 1	130 km/h	125 km/h	120 km/h
PU	1 pc(s)	1 pc(s)	1 pc(s)



Fixing bolt

With M10 thread, nut, toothed lock washer and screw for accommodating the spacer bar.

Part No.	106 301	106 309
Material of bolt	Al	StSt
Clamping range Rd	16 mm	16 mm
PU	20 pc(s)	20 pc(s)



Accessories for DEHNiso Spacers

Fixing bracket

With fixing bolt (Al) for spacer bar (Ø16 mm).



Part No.	106 311
Material	StSt
Angle	90°
Fixing	[4x] Ø5.1 / [2x] Ø6.5 / [2x] 11 x 20 mm
PU	20 pc(s)

Fixing bracket

For DEHNiso spacer, with hole Ø11 mm.



Part No.	106 310
Material	StSt
Angle	90°
Fixing	[4x] Ø5.1 / [2x] Ø6.5 / [2x] 11 x 20 mm
Dimensions	110 x 60 x 30 mm
PU	20 pc(s)

Fixing bracket

For DEHNiso spacer, with hole Ø11 mm.



Part No.	106 315
Material	StSt
Angle	45°
Fixing	[4x] Ø5.1 / [2x] Ø6.5 / [2x] 11 x 20 mm
Dimensions	104 x 54 x 30 mm
PU	20 pc(s)

Corner bracket

With fixing bolt (Al) for spacer bar (Ø16 mm).



Part No.	106 316
Material	StSt
Angle	90°
Fixing	[8x] Ø5.1 / [4x] Ø6.5 / [4x] 11x20 mm
Dimensions	132 x 155 x 30 mm
PU	1 pc(s)

Pipe clamp

With fixing bush for spacer bars (Ø16 mm) for pipes up to Ø60 mm.



Part No.	106 352
Material of clamp	StSt
Clamping range for pipe Ø	40-60 mm (1 1/4-2")
Material of bush	ZDC
PU	10 pc(s)

Pipe clamp

With fixing bush for spacer bars (Ø16 mm) for pipes up to Ø90 mm.



Part No.	106 353
Material of clamp	StSt
Clamping range for pipe Ø	70-90 mm (2 1/4-3")
Material of bush	ZDC
PU	1 pc(s)

Railing clamp

For square hollow profiles with bush for spacer bars (Ø16 mm).

Part No.	106 312
Material	ZDC / StSt
Clamping range for square profile	20 x 20 to 50 x 50 mm
PU	5 pc(s)



Clip for fixing spacers to pipes

Fixing by means of tensioning straps up to 30 mm (e.g. tensioning strap 25 x 0.3 mm with grip head Part No. 106 323), with fixing bolt for spacer bar (Ø16 mm).

Part No.	106 321
Material of clip	StSt
Material of bolt	Al
Width of slot (l x w)	32 x 6 mm
Fixing	[2x] Ø11 mm
PU	10 pc(s)



Attachment with fixing bush

For fixing spacers (Ø16 mm) to pipes, e.g. using a pipe clamp (Part No. 106 323).

Part No.	106 322
Material	StSt
Width of slot (l x w)	26 x 6 mm
Clamping range Rd	16 mm
PU	10 pc(s)



Pipe clamp

For fixing (clamping) conductor holders (e.g. Part No. 275 319).

Part No.	106 323
Material of head / strap	StSt
Clamping range Ø	50-300 mm
Dimensions of strap	1100 x 25 x 0.3 mm
Material of screw	StSt
PU	10 pc(s)



Clip

Fixed on pipes using a tensioning strap (Part No. 540 901, dimensions 25 x 0.3 mm) in combination with a with grip head (Part No. 106 324), with square hole, suitable for M8 screws.

Part No.	106 320
Material	StSt
Clamping range of tube Ø	approx. 50-300 mm
PU	20 pc(s)



Separate grip head

For combination with endless tensioning strap (Part No. 540 901) in case of larger pipe diameters.

Part No.	106 324
Material of head	StSt
For strap (w x d)	25 x 0.3 mm
Screw	M8 x 20 mm
Material of screw	StSt
PU	20 pc(s)



Tensioning strap



Part No.	540 901
Material	StSt
Strap dimensions (w x d)	25 x 0.3 mm
Length	100 m
Military Name	VG 96953 T05 BB001
PU	1 pc(s)

Adapter for angled support

For air-termination rods (Ø16 mm) with 2 fixing bolts for spacer bars (Ø16 mm).



Part No.	106 325
Material	StSt
Clamping range Rd	16 / 16 mm
PU	10 pc(s)

Adapter for angled support

For supporting tubes DEHNiso Combi (Ø50 mm) with 2 fixing bolts for spacer bars (Ø16 mm).



Part No.	106 326
Material	StSt
Clamping range Rd	50 / 16 mm
PU	1 pc(s)

Fixing adapters

For seam and connection clamps.



Part No.	106 340	106 341	106 342
Material of bar	StSt	StSt	StSt
Bar Ø	8 mm	8 mm	8 mm
Angle	0°	90°	130°
Material of bush	ZDC	ZDC	ZDC
PU	20 pc(s)	20 pc(s)	20 pc(s)

MV clamp

Especially for fixing air-termination rods to spacer bars without fixing bush.



Part No.	393 069
Material	StSt
Conductor support Rd	16 / 16 mm
Conductor routing	fixed
PU	50 pc(s)

Connection clamp with fixing bolt

For fixing spacers (Ø16 mm), e.g. to steel girders.



Part No.	106 319
Clamping range	3-18 mm
Clamping range Rd	16 mm
Material of fixing bolt	Al
Connection with	fixing bolt
PU	1 pc(s)

Air-Termination Rods GRP/Al

Air-termination rods for erecting isolated air-termination systems, e.g. on flat roofs, installed in a concrete base with fixing wedge.

Material factor $k_m = 0.7$ is used to determine the separation distance (length of the spacer bar).
Diameter 16 mm, UV-stabilised, light grey colour, permanent temperature range -50 to +100 °C.

Crimped

Part No.	106 207	106 210
Total length	1660 mm	2000 mm
Insulating clearance	635 mm	975 mm
Material of air-termination tip / bush	Al	Al
Max. gust wind speed (1x base 17 kg, holder distance 1100 mm, Al Ø10 mm)	112 km/h	—
Max. gust wind speed (2x base 17 kg, holder distance 1100 mm, Al Ø10 mm)	126 km/h	102 km/h
PU	10 pc(s)	10 pc(s)



Variable with M10 thread

e.g. for air-termination tip (Part No. 101 001), air-termination tip with MV clamp (Part No. 105 071) (for crossing points) or MV clamp for spanning cables (Part No. 105 079).

Part No.	106 217	106 220
Total length	675 mm	1015 mm
Insulating clearance	635 mm	975 mm
Material of air-termination tip / bush	Al	Al
PU	10 pc(s)	10 pc(s)



Accessories for Air-Termination Rods GRP/Al

Air-termination tip with lock nut

Screw-in design

Part No.	101 001
Material	StSt
Diameter Ø	10 mm
Length	1000 mm
Thread	M10
Standard	EN 62561-2
PU	1 pc(s)



Air-termination tip with MV clamp

Screw-in design

Part No.	105 071
Material of air-termination tip	StSt
Air-termination tip (l x Ø)	1000 x 10 mm
Clamping range Rd	8-10 mm
Standard	EN 62561-(1+2)
PU	1 pc(s)



MV clamp for spanning cables

Screw-in design

Part No.	105 079
Material	StSt
Clamping range Rd	8-10 mm
Standard	EN 62561-1
PU	1 pc(s)



DEHNiso Roof Conductor Holders



Variable range of holders for keeping the separation distance when installing conductors on flat roofs. Spacer bar made of glass-fibre reinforced plastic (GRP) Ø10 mm, UV-stabilised, light grey colour. Spacer with concrete block and base plate for conductors Rd 8 mm.

Spacer with concrete block and base plate, loose conductor routing.

Note: Please contact us to find out whether the material of the roof conductor holder or base plate is compatible with the roof elements.



Part No.	253 115	253 125
Material of roof conductor holder	plastic / GRP	plastic / GRP
Length	295 mm	435 mm
Insulating clearance	220 mm	360 mm
Total weight	approx. 4.8 kg	approx. 4.8 kg
Permanent temperature range	-30 °C ... +80 °C	-30 °C ... +80 °C
Max. gust wind speed (holder distance 1200 mm, Al Ø8 mm)	179 km/h	142 km/h
PU	24 pc(s)	24 pc(s)

Accessories for DEHNiso Roof Conductor Holders

Spacer bar with conductor holder

For insertion into the base plate (lock bush), stabilised with concrete block. For raised conductor routing, loose conductor routing.

Part No.	253 315	253 325
Material of conductor holder	plastic	plastic
Length	280 mm	420 mm
Insulating clearance	220 mm	360 mm
Permanent temperature range	-30 °C ... +80 °C	-30 °C ... +80 °C
PU	24 pc(s)	24 pc(s)



Conductor holder with lock bush

For fixing the conductor to the GRP bar.

Part No.	253 302
Material	plastic
Colour	grey ●
Conductor support Rd	8 mm
Permanent temperature range	-30 °C ... +80 °C
PU	24 pc(s)



Spacer bar for DEHNiso roof conductor holders

Cut to length (variable length).

Part No.	253 310
Material	GRP
Colour	light grey (RAL 7035) ●
Diameter Ø	10 mm
Length	3000 mm
Permanent temperature range	-30 °C ... +80 °C
PU	10 pc(s)



Concrete block

For stabilising the base plate.

Part No.	253 301
Material	concrete (C35/45)
Weight	4.6 kg
Dimensions	180 x 180 x 70 mm
PU	24 pc(s)



Base plate

Base plate to hold the spacer bar (Part No. 253 315, 253 325) and conductor holder (Part No. 253 289) and to protect the roof sheeting under the concrete block (Part No. 253 301).

Part No.	253 300
Diameter Ø	300 mm
Diameter Ø of lock bush	10 mm
Height	60 mm
Material	plastic
Colour	grey ●
PU	24 pc(s)



DEHNiso Combi Sets

Components for isolated air-termination systems.

For protecting large roof-mounted structures, e.g. air-conditioning systems, heat exchangers, etc.

For keeping the separation distance to electrically conductive parts according to IEC/EN 62305-3.

Material factor $k_m = 0.7$ is used to determine the separation distance (insulating clearance).

One-piece, total height 4200 mm

Consisting of:

1x air-termination tip StSt, L = 1000 mm (Part No. 105 071)

1x supporting tube GRP/Al, L = 3200 mm (Part No. 105 300)

2x wall fixing bracket StSt (Part No. 105 340)

1x spacer GRP/Al, L = 1030 mm (Part No. 106 331)

Part No.	105 440
Total length	4200 mm
Number of fixing brackets	2
Length of supporting tube	3200 mm
Max. free length with air-termination tip	3500 mm
Max. gust wind speed	134 km/h
Material of supporting tube	GRP / Al
PU	1 pc(s)

One-piece, total height 5700 mm

Consisting of:

1x air-termination tip StSt, L = 1000 mm (Part No. 105 071)

1x supporting tube GRP/Al, L = 4700 mm (Part No. 105 301)

3x wall fixing bracket StSt (Part No. 105 340)

2x spacer GRP/Al, L = 1030 mm (Part No. 106 331)

Part No.	105 455
Total length	5700 mm
Number of fixing brackets	3
Length of supporting tube	4700 mm
Max. free length with air-termination tip	4000 mm
Max. gust wind speed	130 km/h
Material of supporting tube	GRP / Al
PU	1 pc(s)

Two-piece, total height 7200 mm

(transport length 3200 mm)

Consisting of:

1x air-termination tip StSt, L = 1000 mm (Part No. 105 071)

1x supporting tube GRP/Al, L = 6200 mm (Part No. 105 302)

3x wall fixing bracket StSt (Part No. 105 340)

3x spacer GRP/Al, L = 1030 mm (Part No. 106 331)

Part No.	105 470
Total length	7200 mm
Number of fixing brackets	3
Length of supporting tube	6200 mm
Max. free length with air-termination tip	4000 mm
Max. gust wind speed	130 km/h
Material of supporting tube	GRP / Al
PU	1 pc(s)



Accessories for DEHNiso Combi Sets

Air-termination tip with MV clamp

For screwing into the head of the supporting tube and fixing air-termination conductors (wires or cables).

With M10 thread.

Part No.	105 071
Material of air-termination tip	StSt
Air-termination tip (l x Ø)	1000 x 10 mm
Clamping range Rd	8-10 mm
Thread	M10
Standard	EN 62561-(1+2)
PU	1 pc(s)





MV clamp for spanning cables

For screwing into the head of the supporting tube, with M10 screw, for spanning cables

Part No.	105 079
Material	StSt
Clamping range Rd	8-10 mm
Standard	EN 62561-1
PU	1 pc(s)

Supporting tubes GRP / Al

For isolated air-termination systems, with female thread, for air-termination tips or MV clamps for spanning cables. One-piece.

Part No.	105 300	105 301
Material of supporting tube	GRP / Al	GRP / Al
Length of supporting tube	3200 mm	4700 mm
Outside diameter Ø	50 mm	50 mm
Length of insulating clearance	1535 mm	1535 mm
PU	1 pc(s)	1 pc(s)

Supporting tube GRP / Al

For isolated air-termination systems, with female thread, for air-termination tips or MV clamps for spanning cables. Also suitable for fixing the HVI Conductor. Two-piece.

Part No.	105 302
Material of supporting tube	GRP / Al
Length of supporting tube	6200 mm
Outside diameter Ø	50 mm
Length of insulating clearance	1535 mm
PU	1 pc(s)

Supporting tube GRP / Al

One-piece, combined with air-termination rod Ø16 / 10 mm, length 2500 mm, Al.

Part No.	105 306
Material of supporting tube	GRP / Al
Total length	5700 mm
Length of supporting tube	3200 mm
Outside diameter Ø	50 mm
Length of insulating clearance	1535 mm
PU	1 pc(s)

Wall mounting bracket for horizontal mounting, flat

For fixing supporting tubes onto the structure to be protected or the wall.

Part No.	105 340
Material	StSt
Clamping range for supporting tube	50 mm
Distance from wall / corner	80 mm
Dimensions of fixing	320 mm
Fixing	[8x] Ø5.1 / [4x] 11 x 20 mm
PU	1 pc(s)

Wall mounting bracket for horizontal mounting, corner

For fixing supporting tubes onto the structure to be protected or the wall.

Part No.	105 341
Material	StSt
Clamping range for supporting tube	50 mm
Distance from wall / corner	80 mm
Dimensions of fixing	152 mm
Fixing	[8x] Ø5.1 / [4x] 11 x 20 mm
PU	1 pc(s)



Wall mounting bracket for vertical mounting

For fixing the supporting tubes or air-termination rods D40 / D50 to roof-mounted structures or walls.

Part No.	105 342	105 348
Material of bracket	StSt	StSt
Fixing	[8x] Ø5.1 / [4x] 7 x 10 / [2x] 11 x 20 mm	[8x] Ø5.1 / [4x] 7 x 10 / [2x] 11 x 20 mm
Clamping range for supporting tube	40-50 mm	40-50 mm
Distance from wall	46 mm	110 mm
PU	1 pc(s)	1 pc(s)



Wall mounting bracket, adjustable from 150-200 mm

For fixing supporting tubes or air-termination rods D40 / D50 with double clamp, for the connecting 2x Rd 8-10 mm.

Part No.	105 344
Material of bracket	StSt
Clamping range for supporting tube	40-50 mm
Distance from wall	150-200 mm
Dimensions of plate	120 x 120 x 4 mm
Fixing	[4x] 12 x 26 mm
Standard	EN 62561-1
PU	1 pc(s)



Wall mounting bracket, adjustable from 230-1300 mm

For fixing supporting tubes or air-termination rods D40 / D50.

Part No.	105 347	105 343	105 349
Material of bracket	St/tZn / StSt	St/tZn / StSt	St/tZn / StSt
Clamping range for supporting tube	40-50 mm	40-50 mm	40-50 mm
Distance from wall	230-400 mm	400-700 mm	700-1300 mm
Dimensions of plate	120 x 120 x 4 mm	120 x 120 x 4 mm	120 x 120 x 4 mm
Fixing	[4x] 12 x 26 mm	[4x] 12 x 26 mm	[4x] 12 x 26 mm
PU	1 pc(s)	1 pc(s)	1 pc(s)



Fixing clamp with tensioning strap

For fixing supporting tubes to structural elements, e.g. antenna masts.

Part No.	105 360
Material of clip	StSt
Clamping range for supporting tube	50 mm
Clamping range for pipe Ø	50-300 mm
Material of tensioning strap	StSt
Dimensions of strap (w x d)	25 x 0.3 mm
PU	1 pc(s)



Fixing clamp with tensioning strap

With additional spacer for adjusting the sector antenna holders to the mast.

Part No.	105 361
Material of clip	StSt
Clamping range for supporting tube	50 mm
Clamping range for pipe Ø	50-300 mm
Material of tensioning strap	StSt
Dimensions of strap (w x d)	25 x 0.3 mm
Length of spacer	30 mm
PU	1 pc(s)



Fixing clamp with tensioning strap

With additional long spacer for adjusting sector antenna holders to the mast.



Part No.	105 362
Material of clip	StSt
Clamping range for supporting tube	50 mm
Clamping range for pipe Ø	50-300 mm
Material of tensioning strap	StSt
Dimensions of strap (w x d)	25 x 0.3 mm
Length of spacer	95 mm
PU	1 pc(s)

Railing clamp

For pipes.



Part No.	105 354
Material	StSt
Clamping range for pipe Ø	48-60 mm (1 1/2-2")
Clamping range for supporting tube	40-50 mm
PU	5 pc(s)

Railing clamp

With spacer for adjusting, e.g. antenna holders.

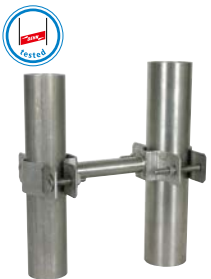

Part No.	105 162
Material	StSt
Clamping range for pipe Ø	45-65 mm (1 1/2-2")
Clamping range for supporting tube	40-50 mm
Length of spacer	95 mm
Standard	EN 62561-1
PU	1 pc(s)

Railing clamp

For pipes.



Part No.	105 355
Material	StSt
Clamping range for pipe Ø	70-90 mm (2 1/4-3")
Clamping range for supporting tube	40-50 mm
PU	1 pc(s)

Railing clamp

For square hollow profiles.



Part No.	105 356	105 376
Material	StSt	StSt
Clamping range for square profile	20 x 20 to 50 x 50 mm	60 x 120 mm
Clamping range for supporting tube	40-50 mm	40-50 mm
PU	5 pc(s)	1 pc(s)

Pipe clamp

With fixing bush for spacer bars (Ø16 mm) for pipes up to Ø60 mm.



Part No.	106 352
Material of clamp	StSt
Clamping range for pipe Ø	40-60 mm (1 1/4-2")
Material of bush	ZDC
PU	10 pc(s)

Pipe clamp

With fixing bush for spacer bars (Ø16 mm) for pipes up to Ø90 mm.



Part No.	106 353
Material of clamp	StSt
Clamping range for pipe Ø	70-90 mm (2 1/4-3")
Material of bush	ZDC
PU	1 pc(s)

Railing clamp

For square hollow profiles with bush for spacer bars (Ø16 mm).

Part No.	106 312
Material	ZDC / StSt
Clamping range for square profile	20 x 20 to 50 x 50 mm
PU	5 pc(s)



Spacers for supporting tubes

For fixing conductors to the supporting tube and keeping the separation distance according to IEC/EN 62305-3.

Part No.	106 328	106 331
Material of spacer	GRP	GRP
Material of fixing element	StSt	StSt
Total length	690 mm	1030 mm
Insulating clearance	605 mm	945 mm
Permanent temperature range	-50 °C ... +100 °C	-50 °C ... +100 °C
PU	1 pc(s)	1 pc(s)



Tripod for DEHNiso Combi

For installing self-supporting supporting tubes D50 mm or air-termination rods D40 mm with a length of 3200 mm (e.g. Part No. 105 300 or 105 440), without additional fixing to structural parts.

Adjustable to the roof inclination up to max. 10°.

Connection with double clamp for 2x Rd 8-10 mm [lightning current carrying capability 100 kA (10/350 µs)].

The stackable concrete base (Part No. 102 010) and the base plate (Part No. 102 050) have to be ordered separately.

Folding for transport.

Part No.	105 200
Material of tripod	St/tZn
Support	40 / 50 mm
Number of concrete blocks	6 / 9 blocks, 17 kg each
Radius	560 mm
Space required for tripod	1200 x 1330 mm
Standard	EN 62561-1
PU	1 pc(s)



Tripod D50

For installing self-supporting supporting tubes, D50 mm, length 4.7-6.2 m (e.g. Part No. 105 455 or 105 470), without additional fixing to structural parts.

Adjustable to a roof inclination up to max. 10°.

Connection with double clamp for 2x Rd 8-10 mm [lightning current carrying capability 100 kA (10/350 µs)].

The stackable concrete bases (Part No. 102 010) and the base plate (Part No. 102 050) have to be ordered separately.

Folding for transport.

Part No.	105 201
Material of tripod	St/tZn
Support	40 / 50 mm
Number of concrete bases	3-12 blocks, 17 kg each
Radius	1435 mm
Required space for tripod	2530 x 2850 mm
Standard	EN 62561-1
PU	1 pc(s)



Bracing

Bracing, 3-fold with clamp for tubes D 50 mm for fixing onto the tripod (Part No. 105 201). Bracing suitable for supporting tubes with a length of 4700 mm (e.g. Part Nos. 105 332, 105 316, 105 333, 105 317, 105 322, 105 323, 105 565, 105 575).

Part No.	105 601
Material	StSt
Brace length	2910 mm
Ø clamp	50 mm
PU	1 pc(s)

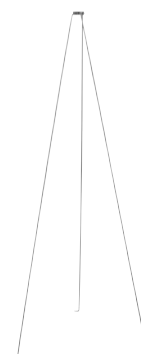



DEHN protects.

Fixed Earthing Terminals



For installation in concrete as a corrosion-free connection to the earth-termination system for protective equipotential bonding and / or functional equipotential bonding of the down conductor, e.g. to the reinforcement of buildings.
Please observe the following minimum screw lengths for the M10 and M12 double threads:
35 mm of M10 (thread length 40 mm)
15 mm of M12 (thread length 20 mm)

Type M

With connecting shaft (l = 180 mm, Ø10 mm).

Part No.	478 011	478 019
Connection thread	M10 / M12	M10 / M12
Material of plate	StSt (V4A)	StSt (V4A)
Material No.	1.4571 / 1.4404 / 1.4401	1.4571 / 1.4404 / 1.4401
ASTM / AISI:	316Ti / 316L / 316	316Ti / 316L / 316
Material of shaft	St/tZn	StSt
Connection plate Ø	80 mm	80 mm
Short-circuit current (50 Hz) (1 s; ≤ 300 °C)	6.5 kA	3.9 kA
Standard	EN 62561-1	EN 62561-1
PU	10 pc(s)	10 pc(s)



Type M without connecting shaft

Part No.	478 012
Connection thread	M10 / M12
Material of plate	StSt (V4A)
Material No.	1.4571 / 1.4404 / 1.4401
ASTM / AISI:	316Ti / 316L / 316
Connection plate Ø	80 mm
Short-circuit current (50 Hz) (1 s; ≤ 300 °C)	9.3 kA (with copper cable lug)
Standard	EN 62561-1
PU	10 pc(s)

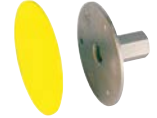

Type M, press-fitted

Connecting shaft (l = 180 mm, Ø10 mm).

Part No.	478 041	478 049
Connection thread	M10 / M12	M10 / M12
Material of plate	StSt (V4A)	StSt (V4A)
Material No.	1.4571 / 1.4404 / 1.4401	1.4571 / 1.4404 / 1.4401
ASTM / AISI:	316Ti / 316L / 316	316Ti / 316L / 316
Material of shaft	St/tZn	StSt
Connection plate Ø	80 mm	80 mm
Short-circuit current (50 Hz) (1 s; ≤ 300 °C)	3.7 kA	3.3 kA
Standard	EN 62561-1	EN 62561-1
PU	10 pc(s)	10 pc(s)



Part No. 478 049 with UL approval.

Type M, press-fitted, with additional water barrier

Protection against water ingress along the shaft into the wall (tested according to EN 62561-5 with 5 bar compressed air and 1 bar pressure water). Suitable for waterproof concrete.

Part No.	478 051
Connection thread	M10 / M12
Material of plate	StSt (V4A)
Material No.	1.4571 / 1.4404 / 1.4401
ASTM / AISI:	316Ti / 316L / 316
Material of shaft	St/tZn
Connection plate Ø	80 mm
Short-circuit current (50 Hz) (1 s; ≤ 300 °C)	3.7 kA
Material of water barrier	PVC
Standard	EN 62561-1
PU	1 pc(s)



Type M with MV clamp For round conductors 8-10 mm, space-saving installation in the formwork.



Part No.	478 112
Connection thread	M10 / M12
Material of plate	StSt (V4A)
Material No.	1.4571 / 1.4404 / 1.4401
ASTM / AISI:	316Ti / 316L / 316
Material of MV clamp	St/tZn
Connection plate Ø	80 mm
Short-circuit current (50 Hz) (1 s; ≤ 300 °C)	9.3 kA
Standard	EN 62561-1
PU	10 pc(s)

Type K With plastic ring and connecting shaft (l = 180 mm, Ø10 mm).

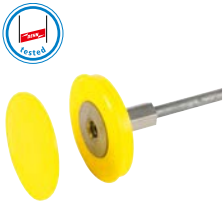

Part No.	478 200
Connection thread	M10 / M12
Material of plate	StSt (V4A)
Material No.	1.4571 / 1.4404 / 1.4401
ASTM / AISI:	316Ti / 316L / 316
Material of shaft	St/tZn
Connection plate Ø	46 mm
Short-circuit current (50 Hz) (1 s; ≤ 300 °C)	6.5 kA
Standard	EN 62561-1
PU	10 pc(s)

Accessory for Fixed Earthing Terminals

Foam pad

Foam pad is attached to the yellow protective cover of the fixed earthing terminal (see installation instructions DS1476). One side adhesive, with pull-off tab. Using the foam pad enables a position compensation of approx. 20 mm at the formwork and makes it easier to find and expose the fixed earthing terminal after concreting.



Part No.	478 098
Diameter Ø	90 mm
Height	20 mm
PU	10 pc(s)

Fixed Earthing Terminal M16



With M16 connection thread for higher current loads (50 Hz), e.g. for connecting the ring equipotential bonding system with the earth-termination systems of power installations with nominal AC voltages over 1 kV (transformer earthing).



Part No.	478 027
Connection thread	M16
Material of plate	StSt (V4A)
Material No.	1.4571 / 1.4404 / 1.4401
ASTM / AISI:	316Ti / 316L / 316
Material of cable	Cu/gal Sn
Cross-section of connecting cable	70 mm ²
Length of connecting cable	400 mm
Diameter Ø connecting cable	10.5 mm
Connection plate Ø	80 mm
Standard	EN 62561-1
Short-circuit current (50 Hz) (1 s; ≤ 300 °C)	11 kA
PU	1 pc(s)

Wall Bushings



With MV clamp made of StSt (V4A) for round conductors 8-10 mm. Water-pressure-tight wall bushing for leading earthing conductors / equipotential bonding conductors through brickwork or walls; with M10 threaded rod made of StSt. For subsequent installation through borehole (Ø14 mm) or through spacer in the formwork. Pressurised water test up to 1 bar represents an installation depth of 10 m in stagnant water.



Part No.	478 410	478 430	478 450
Length of bushing	100-300 mm	300-500 mm	500-700 mm
Length of threaded rod	308 mm	508 mm	708 mm
Sealings	Neoprene	Neoprene	Neoprene
Sealing disc Ø	80 mm	80 mm	80 mm
Material of disc	StSt (V4A)	StSt (V4A)	StSt (V4A)
Material No.	1.4571 / 1.4404 / 1.4401	1.4571 / 1.4404 / 1.4401	1.4571 / 1.4404 / 1.4401
ASTM / AISI:	316Ti / 316L / 316	316Ti / 316L / 316	316Ti / 316L / 316
Short-circuit current (50 Hz) (1 s; ≤ 300 °C)	2.7 kA	2.7 kA	2.7 kA
Standard	EN 62561-1	EN 62561-1	EN 62561-1
PU	1 pc(s)	1 pc(s)	1 pc(s)

Water-Pressure-Tight Wall Bushings for White Tank



For installation in the formwork.

Water-pressure-tight wall bushing, e.g. for connecting the ring earth electrode with the equipotential bonding bar or the equipotential bonding conductor in the foundation.

Pressurised water test up to 1 bar represents an installation depth of 10 m in stagnant water.

Tested with 5 bar compressed air in accordance with EN 62561-5.

Part No.	478 530	478 540	478 550
Material of plate	StSt (V4A)	StSt (V4A)	StSt (V4A)
Material No.	1.4571 / 1.4404 / 1.4401	1.4571 / 1.4404 / 1.4401	1.4571 / 1.4404 / 1.4401
ASTM / AISI:	316Ti / 316L / 316	316Ti / 316L / 316	316Ti / 316L / 316
Material of axis	St/tZn	St/tZn	St/tZn
Wall thickness	200-300 mm	300-400 mm	400-500 mm
Connection thread	M10 / 12	M10 / 12	M10 / 12
Connection plate Ø	80 mm	80 mm	80 mm
Short-circuit current (50 Hz) (1 s; ≤ 300 °C)	4.1 kA	4.1 kA	4.1 kA
Standard	EN 62561-(1+5)	EN 62561-(1+5)	EN 62561-(1+5)
PU	1 pc(s)	1 pc(s)	1 pc(s)



Sealing Collar for Connection Lug



Sealing collar for bushings in case of watertight foundation slabs / walls (e.g. white tank).

Water-pressure-tight for pushing on round / flat conductors with StSt tensioning straps.

Pressurised water test up to 1 bar represents an installation depth of 10 m in stagnant water, additionally tested with 5 bar compressed air according to EN 62561-5.

For round conductors

Part No.	478 598
Material	thermoplast elastomer
Diameter Ø	105 mm
Bushing Rd	10 mm
Standard	EN 62561-5
PU	10 pc(s)



For flat conductors

Part No.	478 599
Material	thermoplast elastomer
Diameter Ø	119 mm
Bushing Fl	30 x 3.5 mm
Standard	EN 62561-5
PU	10 pc(s)



Connecting Clamps for Fixed Earthing Terminals and Reinforcement

For connecting the reinforcement with clamping piece. For round conductors or fixed earthing terminals with simultaneous fixing in the formwork. Arrangement: (II) = parallel (+) = cross

For small diameters

Part No.	308 035
Material	St/bare
Clamping range Rd / Rd	(+/II) 6-22 / 6-10 mm
Clamping range Rd / Fl	(+) 6-22 / 40 mm
Screw	☛ M10 x 60 mm
Standard	EN 62561-1
Short-circuit current (50 Hz) (1 s; ≤ 300 °C)	1.0 kA
PU	25 pc(s)



U-clamp for large diameters

Part No.	308 046
Material	St/bare
Clamping range Rd / Rd	(+/II) 16-48 / 6-10 mm
Clamping range Rd / Fl	(II) 16-48 / 30-40 mm
Screw	U-bolt M10 x 48 mm
Standard	EN 62561-1
Short-circuit current (50 Hz) (1 s; ≤ 300 °C)	9.9 kA
PU	25 pc(s)

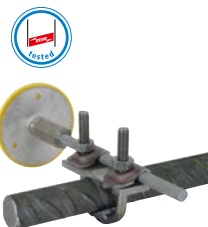

End Pieces

Screwed to the fixed earthing terminal to connect, e.g. an equipotential bonding bar or structural parts such as steel girders, etc.

Basic design

Universal use for M10 and M12 connections, e.g. at the fixed earthing terminal.
For connection of Rd, e.g. with KS connector (Part No. 301 019), or Fl with M10 or M12 screws and nuts.



Part No.	390 499
Material	StSt
Hole Ø	10.5 / 12.5 mm
PU	50 pc(s)

Design with square holes

Dimensions 11x11 mm, for connecting Rd, e.g. with KS connector (Part No. 301 019), or Fl with M10 screws and nuts.



Part No.	390 479
Material	StSt
Distance of holes	30 mm
Hole Ø	13 mm
PU	50 pc(s)

Design with holes and KS connector

With holes Ø11 mm.

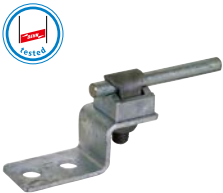

Part No.	363 010
Material	St/tZn
Distance of holes	22 mm
Hole Ø	11 mm
Clamping range Rd	7-10 mm
Standard	EN 62561-1
PU	50 pc(s)

Design with holes

With holes Ø11 mm.



Part No.	363 000
Material	St/tZn
Distance of holes	22 mm
Hole Ø	11 mm
PU	50 pc(s)

Connection Clamps with Threaded Bolt

For connecting round and flat conductors to fixed earthing terminals with M10 / M12 thread (e.g. Part Nos. 478 011, 478 200) and M16 thread (Part No. 478 027). Clamps with M10 thread are also suitable for installation on the rear side of the fixed earthing terminal (without connecting shaft), e.g. to connect a flat strip.

Heavy design M10

Part No.	478 141
Material of clamp	St/tZn
Clamping range Rd / Fl	7-10 / 30-40 mm
Dimensions	70 x 70 x 3 mm
Standard	EN 62561-1
PU	10 pc(s)



Heavy design M12

Part No.	478 149
Material of clamp	StSt (V4A)
Material No.	1.4571 / 1.4404 / 1.4401
ASTM / AISI:	316Ti / 316L / 316
Clamping range Rd / Fl	7-10 / 30-40 mm
Dimensions	70 x 70 x 3 mm
Standard	EN 62561-1
Short-circuit current (50 Hz) (1 s; ≤ 300 °C)	3.3 kA
PU	10 pc(s)

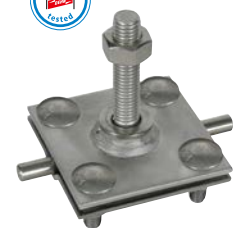

Heavy design M16

Part No.	478 150
Material of clamp	StSt (V4A)
Material No.	1.4571 / 1.4404 / 1.4401
ASTM / AISI:	316Ti / 316L / 316
Clamping range Rd / Fl	7-10 / 30-40 mm
Dimensions	70 x 70 x 3 mm
Standard	EN 62561-1
Short-circuit current (50 Hz) (1 s; ≤ 300 °C)	5.9 kA
PU	10 pc(s)

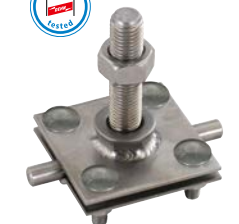

Light design M10

Part No.	478 129
Material of clamp	StSt (V4A)
Material No.	1.4571 / 1.4404 / 1.4401
ASTM / AISI:	316Ti / 316L / 316
Clamping range Rd / Fl	8-10 / 30 mm
Dimensions	58 x 30 x 2.5 mm
Standard	EN 62561-1
Short-circuit current (50 Hz) (1 s; ≤ 300 °C)	2.7 kA
PU	10 pc(s)



Threaded Adapter

For connection to fixed earthing terminals with M10 thread, lock nut and spring washer, for use in case of perimeter insulation or thermal insulation composite systems.

Part No.	478 699
Material	StSt (V4A)
Material No.	1.4571 / 1.4404 / 1.4401
ASTM / AISI:	316Ti / 316L / 316
Female thread	M10 x 25 mm
Male thread	M10 x 80 mm
Total length	130 mm
Standard	EN 62561-1
PU	10 pc(s)



Connecting Clamps for Reinforcements

In accordance with the German standard DIN 18014: 2014-03 Fundamenteerder – Planung, Ausführung und Dokumentation (Foundation earth electrode - Planning, execution and documentation), foundation earth electrodes have to be connected with the reinforcement of the foundation slab at intervals of 2 metres. Of the various connection possibilities, clamp connections have turned out to be the most economic as they can be implemented quickly and easily on site.

According to the current lightning protection standards, reinforcing steels should, among other things, be used as natural components of the down conductor system. The table below provides an overview of the nominal and outer diameters as well as cross sections of the reinforcing steels DIN EN 10080: 2005.

For connecting reinforcing steel meshes or reinforcements with round and flat conductors.
Arrangement: (||) = parallel (+) = cross



The outer diameter including corrugation is approx. $d_A = 1.15 \times d_s$.

Nominal diameter d_s (mm)	6	8	10	12	14	16	20	25	28	32	40
Average outer diameter incl. corrugation d_A (mm)	7.1	9.4	11.8	14.2	16.5	18.9	23.6	29.5	33.1	37.8	47.2
Nominal cross section (mm ²)	28.3	50.3	78.5	113.1	154	201	314	491	616	804	1257

DEHNclip Rebar Clamp



Quick and safe:

DEHNclip rebar clamp for quick connection of the earth electrode to the reinforcement without tools. DEHNclip is tested for a lightning current carrying capability of 50 kA (10/350 μ s) in accordance with EN 62561-1.

For connecting round conductors with the reinforcement

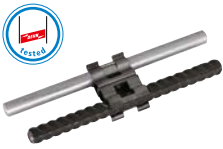

Part No.	308 130	308 131	308 132	308 133
Material	St/bare	St/bare	St/bare	St/bare
Clamping range Rd* / Rd	6-7 / 10 mm	8-9 / 10 mm	10 / 10 mm	12 / 10 mm
Short-circuit current (50 Hz) (1 s; ≤ 300 °C)	2.5 kA	2.7 kA	2.4 kA	2.7 kA
Standard	EN 62561-1	EN 62561-1	EN 62561-1	EN 62561-1
PU	50 pc(s)	50 pc(s)	50 pc(s)	50 pc(s)

* Nominal diameter d_s of the reinforcement

For connecting flat conductors with the reinforcement



Part No.	308 140	308 141	308 142	308 143
Material	St/bare	St/bare	St/bare	St/bare
Clamping range Rd* / FI	6-7 / 30 mm	8-9 / 30 mm	10 / 30 mm	12 / 30 mm
Short-circuit current (50 Hz) (1 s; ≤ 300 °C)	2.0 kA	2.3 kA	2.3 kA	2.3 kA
Standard	EN 62561-1	EN 62561-1	EN 62561-1	EN 62561-1
PU	50 pc(s)	50 pc(s)	50 pc(s)	50 pc(s)

* Nominal diameter d_s of the reinforcement

For connecting reinforcing steel



Part No.	308 134	308 135	308 137	308 136
Material	St/bare	St/bare	St/bare	St/bare
Clamping range Rd* / Rd*	6-7 / 6-7 mm	8-9 / 8-9 mm	8-9 / 12 mm	12 / 12 mm
Short-circuit current (50 Hz) (1 s; ≤ 300 °C)	2.2 kA	2.4 kA	2.4 kA	2.6 kA
Standard	EN 62561-1	EN 62561-1	EN 62561-1	EN 62561-1
PU	50 pc(s)	50 pc(s)	50 pc(s)	50 pc(s)

* Nominal diameter d_s of the reinforcement

Connecting Clamps for Reinforcements

For T, cross and parallel connections

Part No.	308 025
Material	St/tZn
Clamping range Rd / Rd	(+) 6-10 / 6-10 mm
Clamping range Rd / Fl	(+) 6-10 / 30 mm
Clamping range Fl / Fl	(II) 30 / 30 mm
Screw	☛ M10 x 25 mm
Short-circuit current (50 Hz) (1 s; ≤ 300 °C)	9 kA
Standard	EN 62561-1
PU	50 pc(s)



For T, cross and parallel connections

Part No.	308 026
Material	St/tZn
Clamping range Rd / Fl	(+) 6-10 / 30 mm
Clamping range Fl / Fl	(+ / II) 30 / 30 mm
Screw	☛ M10 x 25 mm
Short-circuit current (50 Hz) (1 s; ≤ 300 °C)	13 kA
Standard	EN 62561-1
PU	25 pc(s)



For T and cross connections

Note: recommended tightening torque ≥ 10 Nm

Part No.	308 030
Material	St/bare
Clamping range Rd / Fl	(+) 6-22 / 30-40 mm
Screw	☛ M10 x 40 mm
Short-circuit current (50 Hz) (1 s; ≤ 300 °C)	1.0 kA
Standard	EN 62561-1
PU	50 pc(s)



For T, cross and parallel connections with clamping piece

For flexible connection of round conductors or for fixed earthing terminals while fixing in the formwork.

Part No.	308 035
Material	St/bare
Clamping range Rd / Rd	(+/II) 6-22 / 6-10 mm
Clamping range Rd / Fl	(+) 6-22 / 40 mm
Screw	☛ M10 x 60 mm
Short-circuit current (50 Hz) (1 s; ≤ 300 °C)	1.0 kA
Standard	EN 62561-1
PU	25 pc(s)



U-bolt clamp for large diameters

Part No.	308 045
Material	St/bare
Clamping range Rd / Rd	(II) 16-48 / 6-10 mm
Clamping range Rd / Fl	(II) 16-48 / 30-40 mm
Screw	U-bolt M10 x 48 mm
Short-circuit current (50 Hz) (1 s; ≤ 300 °C)	16 kA
Standard	EN 62561-1
PU	25 pc(s)



U-bolt clamp for large diameters with two additional clamping pieces

For cross connections of round conductors (6-10 mm) or for fixing and simultaneous connection of fixed earthing terminals.



Part No.	308 046	
Material	St/bare	
Clamping range Rd / Rd	(+/II) 16-48 / 6-10 mm	
Clamping range Rd / Fl	(II) 16-48 / 30-40 mm	
Screw	U-bolt M10 x 48 mm	
Short-circuit current (50 Hz) (1 s; ≤ 300 °C)	9.9 kA	
Standard	EN 62561-1	
PU	25 pc(s)	

MAXI MV clamps

For T, cross and parallel connections.



Part No.	308 041	308 040
Material	St/tZn	St/bare
Clamping range Rd / Rd	(+/II) 8-16 / 15-25 mm	(+/II) 8-16 / 15-25 mm
Screw	☛ M12 x 65 mm	☛ M12 x 65 mm
Short-circuit current (50 Hz) (1 s; ≤ 300 °C)	6.2 kA	10.2 kA
Standard	EN 62561-1	EN 62561-1
UL certification	—	UL467B
Stock No.	5999-12-362-1557	—
PU	20 pc(s)	20 pc(s)

MV clamps with hexagon screw

Threaded base part.



Part No.	390 050	391 050
Material	St/tZn	St/tZn
Clamping range Rd	8-10 mm	10 mm
Screw	☛ M10 x 30 mm	☛ M10 x 35 mm
Short-circuit current (50 Hz) (1 s; ≤ 300 °C)	5.5 kA	—
Standard	EN 62561-1	EN 62561-1
PU	50 pc(s)	50 pc(s)

MV clamps with hexagon screw and spring washer

Threaded base part.



Part No.	390 550
Material	St/tZn
Clamping range Rd	8-10 mm
Screw	☛ M10 x 30 mm
Standard	EN 62561-1
PU	50 pc(s)

Parallel connectors with truss head screw



Part No.	306 121	306 122
Material	St/bare	St/tZn
Clamping range Rd / Rd	6-22 / 6-22 mm	6-22 / 6-22 mm
Screw	☛ M10 x 40 mm	☛ M10 x 40 mm
Short-circuit current (50 Hz) (1 s; ≤ 300 °C)	6.1 kA	6.1 kA
Standard	EN 62561-1	EN 62561-1
PU	50 pc(s)	50 pc(s)

Connecting Clamps for Foundation Earth Electrodes

For connecting round and flat conductors in the concrete foundation.
For T, cross and parallel connections, without having to insert the conductor.

Arrangement:

(II) = parallel
(+) = cross

Part No.	308 120	308 129
Material	St/tZn	StSt
Clamping range Rd / Fl	(+) 10 / 30 mm	(+) 10 / 30 mm
Clamping range Fl / Fl	(+//II) 30 / 30 mm	(+//II) 30 / 30 mm
Standard	EN 62561-1	EN 62561-1
PU	25 pc(s)	25 pc(s)

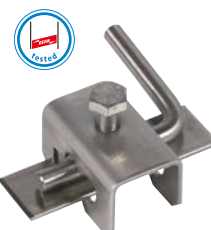

Connecting Clamps for Foundation Earth Electrodes and Reinforcements

For connecting round and flat conductors in the concrete foundation or reinforcing steel meshes and reinforcements with round and flat conductors.

Arrangement:

(II) = parallel
(+) = cross

Connecting clamp with thrust bracket

For T, cross and parallel connections.

Part No.	308 031
Material	St/bare
Clamping range Rd / Rd	(+//II) 6-20 / 8-10 mm
Clamping range Rd / Fl	(+//II) 6-20 / 30 x 3-4 mm
Clamping range Fl / Fl	(+//II) 30 x 3-4 / 30 x 3-4 mm
Short-circuit current (50 Hz) (1 s; ≤ 300 °C)	8.4 kA
Standard	EN 62561-1
PU	25 pc(s)



Connecting clamp MAXI with thrust bracket

For T, cross and parallel connections.

Part No.	308 036
Material	St/bare
Clamping range Rd / Rd	(+//II) 20-32 / 8-10 mm
Clamping range Rd / Fl	(+//II) 20-32 / 40 x 4-5 mm
Short-circuit current (50 Hz) (1 s; ≤ 300 °C)	14.0 kA
Standard	EN 62561-1
PU	25 pc(s)



Connecting clamp without thrust bracket

For cross connections.

Part No.	308 032
Material	St/bare
Clamping range Rd / Fl	(+) 6-20 / 30 x 3-4 mm
Clamping range Fl / Fl	(+) 30 x 3-4 / 30 x 3-4 mm
Standard	EN 62561-1
PU	25 pc(s)



Connecting clamp MAXI without thrust bracket

For cross connections.

Part No.	308 037
Material	St/bare
Clamping range Rd / Fl	(+) 20-32 / 30 x 3-40 x 5 mm
Standard	EN 62561-1
PU	25 pc(s)



HVI Lightning Protection: Our long-standing experience is convincing!

Flexibility and safety of the highest level –
with the high-voltage-resistant, insulated HVI Conductor.
The simple way to keep separation distances.

HVI – Your benefits:

- **One system**
solutions for all applications
- **Satisfied customers**
worldwide
- **Certified solutions**
also for EX areas
- **Mounting material**
suitable for any place of installation
- **Standard requirement**
in accordance with IEC TS 62561-8 Edition 1.0 2018-01
- **Zero lightning current in the building**
insulated structure due to semi-conductive sheath

HVI Lightning Protection
since 2003

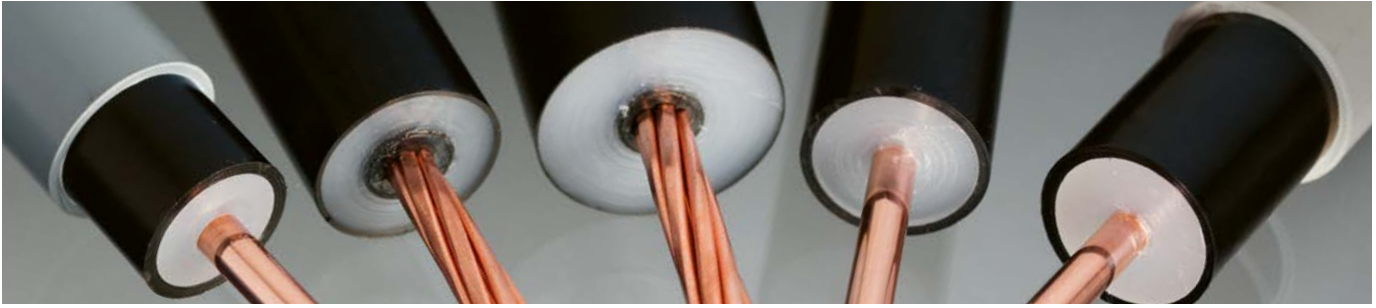

High-voltage-resistant, insulated HVI Conductor: The innovation in external lightning protection

In order to prevent dangerous flashover between components of the external lightning protection system and conductive internal system components (electric lines, pipes, etc.) keeping the **separation distance s** is a crucial factor when designing and implementing a lightning protection system.

Unique design

When using conventional lightning protection systems, it is often not possible to maintain the necessary separation distances. This is no problem with the **HVI Conductor** thanks to its unique design and special sheath. The lightning current carrying conductor of the **HVI Conductor** is wrapped with insulating material in such a way that the required separation distance from other conductive parts of the building, electric lines and pipes is maintained. The conductor consists of an inner copper conductor with a high-voltage-resistant thick-walled insulation and a weather-resistant semi-conductive special outer sheath.

Function of the HVI Conductor

High impulse voltages cause flashover on the surface of insulating material if no additional measures are taken. This effect is also referred to as creeping flashover. If the creeping discharge inception voltage is exceeded, a surface discharge is initiated which can easily flash over a distance of several meters. To prevent creeping discharges, the **HVI Conductor** features a special outer sheath which makes it possible to discharge high lightning impulse voltages to a reference potential. For functional reasons, a connection is established between the semi-conductive outer sheath and the equipotential bonding system of the building (no lightning voltage) in the sealing end range. This connection to the equipotential bonding system can be made, e.g. on earthed metal roof-mounted structures located in the protected zone of the lightning protection system, earthed parts of the building structure that do not carry lightning voltage or the protective conductor of the low-voltage system.

Types of HVI Conductor

In 2003, DEHN launched an innovation in external lightning protection, the high-voltage-resistant, insulated **HVI Conductor**. Since then, thousands of buildings and installations have been successfully equipped with **HVI Lightning Protection**. The large number of **HVI Conductors** installed and intensive development work have given us the edge in terms of experience. This is reflected in the variety of **HVI Conductors**. These meet the differing requirements on lightning protection systems.

The application range was gradually expanded to include **HVI light**, **DEHNcon-H**, **HVI long**, **HVI power** and **HVI power long**. As a result, **HVI Conductors** can be used for an extremely wide range of applications.

The separation distance is crucial

The following overview makes it easier to select the right **HVI Conductor**. The criteria for this selection are the separation distance **s** and the required **class of LPS**.

The IEC 62305-3 standard requires that a defined separation distance be kept as a minimum distance between the lightning protection system and electrically conductive materials. This prevents dangerous flashover and thus sparking, ensuring that lightning currents are reliably conducted to the earth-termination system. The high-voltage-resistant, insulated down conductors from DEHN provide an equivalent separation distance and thus meet the normative requirements.

The separation distance can be calculated automatically by means of the **DEHNsupport Toolbox software**.

Types of HVI Conductor

Three types of **HVI Conductor** are available:

- **HVI light**, **DEHNcon-H**
- **HVI Conductor**, **HVI long Conductor**
- **HVI power**, **HVI power long Conductor**

Each type of **HVI Conductor** has different strengths and characteristics and therefore also different installation requirements. There are also black and grey conductors within the **HVI Conductor** product line. The additional grey sheath allows the **HVI Conductor** to be installed unobtrusively on buildings.

HVI Conductor inside the supporting tube – dimensioned according to Eurocode

Both the material of the supporting tube and sufficient stability are crucial factors when choosing self-supporting air-termination systems with **HVI Conductors** installed inside/outside the supporting tube. The area exposed to wind is larger when **HVI Conductors** are installed outside the supporting tube. The standing surface and the necessary base weight have to be considered accordingly.

The gust wind speed is determined using the following parameters:

- **Wind zone (I-V)**
- **Terrain category**
- **Object height**
- **Height of location above sea level (standard up to 800 m above sea level)**

The table lists the respective maximum gust wind speeds for self-supporting air-termination systems with **HVI Conductors**. They have to be compared with the defined values in the gust wind speeds table. If the max. gust wind speed for an air-termination system is lower than the respective local gust wind speed, the air-termination system is suitable for this application.

If necessary, permissible roof loads must be observed and coordinated with the constructor.

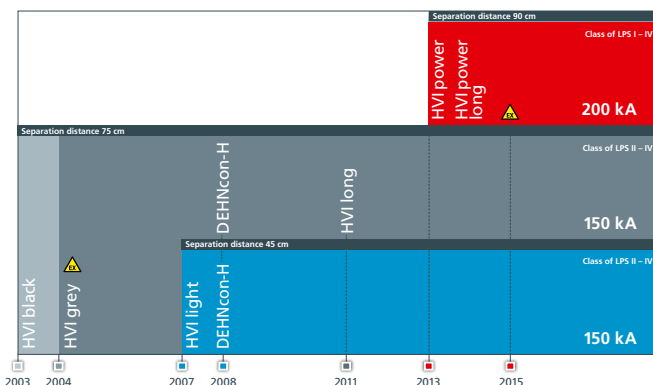

HVI /HVI power Conductor inside the supporting tube – dimensioned according to Eurocode

Max. gust wind speeds in km/h for self-supporting air-termination systems.



Combination kit														
Part No. Supporting tube / Air-termination rods		Installation of HVI / HVI power Conductor		Tripod St/tZn (radius 620 mm) Part No. 105 351			Tripod St/tZn (radius 1435 mm) Part No. 105 201 without bracing				Tripod St/tZn (radius 1435 mm) Part No. 105 201 with bracing Part No. 105 601			
Number of conductors / Number of concrete bases		max. outside	inside	6 bases	9 bases	12 bases	3 bases	6 bases	9 bases	12 bases	6 bases	9 bases	12 bases	
HVI long Conductor Inside and outside installation Non-slotted supporting tube	Part No. 105 330, Al , or Part No. 105 314, StSt L = 3.2 m / ATR = 1.0 m	0	1	134	167	202	—	—	—	—	—	—	—	
		1	0-1	115	136	160	128	172	173	173	—	—	—	—
	Part No. 105 331, Al , or Part No. 105 315, StSt L = 3.2 m / ATR = 2.5 m	2-4	0-1	104	124	139	119	149	149	149	—	—	—	—
		0	1	115	136	158	—	—	—	—	—	—	—	—
	Part No. 105 332, Al , or Part No. 105 316, StSt L = 4.7 m / ATR = 1.0 m	1	0	—	—	—	—	—	—	—	—	111	128	145
		2-4	0	—	—	—	—	—	—	—	—	102	116	131
	Part No. 105 333, Al , or Part No. 105 317, StSt L = 4.7 m / ATR = 2.5 m	1	0	—	—	—	—	—	—	—	—	104	121	134
		2-4	0	—	—	—	—	—	—	—	—	97	111	124
HVI power Conductor Inside installation Non-slotted supporting tube	Part No. 105 320, StSt L = 3.5 m / ATR = 1.0 m	0	1	—	152	179	—	—	—	—	—	—	—	
	Part No. 105 321, StSt L = 3.5 m / ATR = 2.5 m	0	1	—	128	148	—	—	—	—	—	—	—	
HVI power Conductor Inside and outside installation Non-slotted supporting tube	Part No. 105 563, Al L = 3.5 m / ATR = 1.0 m	0	1	—	154	181	—	—	—	—	—	—	—	
		1	0	106	124	142	116	149	152	152	—	—	—	—
	Part No. 105 573, Al L = 3.5 m / FS = 2.5 m	1	1	—	124	142	—	—	—	—	—	—	—	—
		0	1	—	133	150	—	—	—	—	—	—	—	—
	Part No. 105 565, Al L = 5.0 m / FS = 1.0 m	1	0	96	114	130	106	134	134	134	—	—	—	—
		1	1	—	114	130	—	—	—	—	—	—	—	—
	Part No. 105 575, Al L = 5.0 m / ATR = 2.5 m	1	0	—	—	—	—	—	—	—	—	104	122	136
		1	0	—	—	—	—	—	—	—	—	99	115	129

Part No. Supporting tube / Air-termination rods		Installation of HVI / HVI power Conductor		Tripod StSt (radius 600 mm) Part No. 105 390			Four-legged stand StSt (radius 600 mm) Part No. 105 490			Tripod StSt (radius 1450 mm) Part No. 105 391				Four-legged stand StSt (radius 1450 mm) Part No. 105 491			
Number of conductors / Number of concrete bases		max. outside	inside	6 bases	9 bases	12 bases	8 bases	12 bases	16 bases	3 bases	6 bases	9 bases	12 bases	4 bases	8 bases	12 bases	16 bases
HVI long Conductor Outside installation Non-slotted supporting tube	Part No. 105 330, Al , or Part No. 105 314, StSt L = 3.2 m / ATR = 1.0 m	1	0	110	129	149	140	176	206	—	—	—	—	—	—	—	—
		2-4	0	100	116	133	125	154	181	—	—	—	—	—	—	—	—
	Part No. 105 331, Al , or Part No. 105 315, StSt L = 3.2 m / ATR = 2.5 m	1	0	99	116	133	126	150	169	—	—	—	—	—	—	—	—
		2-4	0	93	108	122	117	138	149	—	—	—	—	—	—	—	—
Part No. 105 332, Al , or Part No. 105 316, StSt L = 4.7 m / ATR = 1.0 m	1	0	—	93	105	101	120	132	—	110	127	142	107	141	170	192	
	2-4	0	—	—	95	93	109	115	—	101	115	129	100	129	152	162	
Part No. 105 333, Al , or Part No. 105 317, StSt L = 4.7 m / ATR = 2.5 m	1	0	—	—	99	93	111	116	—	102	119	131	107	133	156	158	
	2-4	0	—	—	93	—	100	104	—	96	112	122	100	122	140	140	
HVI long Conductor Inside and outside installation Slotted supporting tube	Part No. 105 325, Al , or Part No. 105 336, StSt L = 3.2 m / ATR = 1.0 m	0	1	125	151	183	169	234	234	118	151	184	233	151	220	233	233
		1	0-1	110	129	149	140	176	206	106	131	156	183	133	177	214	229
	Part No. 105 326, Al , or Part No. 105 337, StSt L = 3.2 m / ATR = 2.5 m	2-4	0-1	100	116	133	125	154	181	100	122	142	164	125	161	193	202
		0	1	110	131	149	140	176	189	108	133	160	187	135	180	188	188
	Part No. 105 327, Al , or Part No. 105 338, StSt L = 4.7 m / ATR = 1.0 m	1	0-1	99	116	133	126	150	169	99	122	142	165	125	160	170	170
		2-4	0-1	93	108	122	119	138	149	94	116	134	151	119	149	154	154
	Part No. 105 328, Al , or Part No. 105 339, StSt L = 4.7 m / ATR = 2.5 m	0	1	93	110	124	119	140	159	100	123	145	170	118	165	217	233
		1	0-1	—	93	105	101	120	132	—	110	127	142	107	141	170	192
Part No. 105 392, StSt L = 3.5 m / ATR = 1.0 m	0	1	—	—	95	93	109	115	—	101	115	129	100	129	152	162	
	2-4	0-1	—	—	93	—	100	104	—	96	112	122	100	122	140	140	
HVI power Conductor Inside installation Slotted supporting tube	Part No. 105 393, StSt L = 3.5 m / ATR = 2.5 m	0	1	104	122	140	133	162	164	104	129	152	162	131	162	162	162
	Part No. 105 394, StSt L = 5.0 m / ATR = 1.0 m	0	1	122	104	118	114	133	146	97	120	139	158	122	154	192	234
	Part No. 105 395, StSt L = 5.0 m / ATR = 2.5 m	0	1	—	95	107	104	122	131	—	112	129	143	114	142	162	162
HVI power Conductor Outside installation Non-slotted supporting tube	Part No. 105 563, Al L = 3.5 m / ATR = 1.0 m	1	0	100	120	136	129	156	186	—	—	—	—	—	—	—	—
	Part No. 105 573, Al L = 3.5 m / ATR = 2.5 m	1	0	—	110	124	119	142	147	—	—	—	—	—	—	—	—
	Part No. 105 565, Al L = 5.0 m / ATR = 1.0 m	1	0	—	—	100	95	114	121	—	103	119	134	106	133	156	162
	Part No. 105 575, Al L = 5.0 m / ATR = 2.5 m	1	0	—	—	93	—	104	108	—	98	112	127	100	125	140	140
HVI power Conductor Inside and outside installation Slotted supporting tube	Part No. 105 513, Al L = 3.5 m / ATR = 1.0 m	0	1	120	142	168	154	199	238	113	143	173	215	143	193	237	237
		1	0-1	100	120	136	129	156	186	99	124	145	169	125	163	192	192
	Part No. 105 543, Al L = 3.5 m / ATR = 2.5 m	0	1	104	123	140	133	164	169	102	130	152	170	131	169	169	169
		1	0-1	—	110	124	119	142	147	—	115	134	146	118	148	148	148
	Part No. 105 515, Al L = 5.0 m / ATR = 1.0 m	0	1	—	104	120	114	133	145	96	121	141	160	122	156	192	235
		1	0-1	—	—	100	95	114	121	—	103	119	134	106	133	156	162
	Part No. 105 545, Al L = 5.0 m / ATR = 2.5 m	0	1	—	95	109	104	122	129	—	111	129	145	114	142	169	169
		1	0-1	—	—	93	—	104	108	—	98	112	127	100	125	140	140

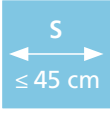
<p>HVI light Conductor DEHNcon-H</p>		<p>Separation distance $s \leq 45$ cm "air" $s \leq 90$ cm "solid material"</p>	
<p>Technical data</p>		<p>HVI light Conductor / DEHNcon-H</p>	
<p>Outer diameter / colour</p>		<p>20 mm / dark grey</p>	
<p>Equivalent separation distance (air)</p>		<p>≤ 45 cm</p>	
<p>Equivalent separation distance (solid material)</p>		<p>≤ 90 cm</p>	
<p>Operating temperature</p>		<p>-30 °C ... +70 °C</p>	
<p>Tested with I_{imp} (10/350 μs) based on EN 62561-1</p>		<p>150 kA</p>	
<p>For use in class of LPS in case of a single down conductor without current distribution ($k_c = 1$)</p>		<p>II, III, IV</p>	
<p>Installation in Ex zone 1 and 21</p>		<p>not allowed</p>	
<p>Maximum permissible conductor length LPL II (at $k_c = 1$)</p>		<p>7.5 m</p>	
<p>Maximum permissible conductor length LPL III / IV (at $k_c = 1$)</p>		<p>11.25 m</p>	

<p>HVI Conductor HVI long Conductor DEHNcon-H</p>		<p>Separation distance $s \leq 75$ cm "air" $s \leq 150$ cm "solid material"</p>	
<p>Technical data</p>		<p>HVI Conductor / HVI long Conductor / DEHNcon-H</p>	
<p>Outer diameter / colour</p>		<p>20 mm / black or 23 mm / grey</p>	
<p>Equivalent separation distance (air)</p>		<p>≤ 75 cm</p>	
<p>Equivalent separation distance (solid material)</p>		<p>≤ 150 cm</p>	
<p>Operating temperature</p>		<p>-30 °C ... +70 °C</p>	
<p>Tested with I_{imp} (10/350 μs) based on EN 62561-1</p>		<p>150 kA</p>	
<p>For use in class of LPS in case of a single down conductor without current distribution ($k_c = 1$)</p>		<p>II, III, IV</p>	
<p>Installation in Ex zone 1 and 21</p>		<p>allowed</p>	
<p>Maximum permissible conductor length LPL II (at $k_c = 1$)</p>		<p>12.5 m</p>	
<p>Maximum permissible conductor length LPL III / IV (at $k_c = 1$)</p>		<p>18.75 m</p>	

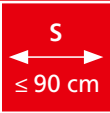
<p>HVI power Conductor HVI power long Conductor</p>		<p>Separation distance $s \leq 90$ cm "air" $s \leq 180$ cm "solid material"</p>	
<p>Technical data</p>		<p>HVI power Conductor / HVI power long Conductor</p>	
<p>Outer diameter / colour</p>		<p>27 mm / black</p>	
<p>Equivalent separation distance (air)</p>		<p>≤ 90 cm</p>	
<p>Equivalent separation distance (solid material)</p>		<p>≤ 180 cm</p>	
<p>Operating temperature</p>		<p>-50 °C ... +70 °C</p>	
<p>Tested with I_{imp} (10/350 μs) based on EN 62561-1</p>		<p>200 kA</p>	
<p>For use in class of LPS in case of a single down conductor without current distribution ($k_c = 1$)</p>		<p>I, II, III, IV</p>	
<p>Installation in Ex zone 1 and 21</p>		<p>allowed</p>	
<p>Maximum permissible conductor length LPL I (at $k_c = 1$)</p>		<p>11.25 m</p>	
<p>Maximum permissible conductor length LPL II (at $k_c = 1$)</p>		<p>15.0 m</p>	
<p>Maximum permissible conductor length LPL III / IV (at $k_c = 1$)</p>		<p>22.5 m</p>	

HVI light Conductor



The HVI light Conductor supplements the tried and tested HVI Conductor. It enriches the design possibilities in lightning protection as it has been specially designed for low, large-scale buildings where the separation distance cannot be maintained with conventional lightning protection systems.

A significant advantage of the HVI light Conductor is that it is easy and quick to install.

A sealing end which is connected to the functional equipotential bonding system of the building is not required. Instead, the conductor is connected at a defined coupling point to the supporting tube in the tripod. This does not have to be connected to the functional equipotential bonding system.

Nowadays, the roof area of buildings is often used as an installation level for pipes, electric and information technical systems or photovoltaic installations regardless of the potential risk of lightning strikes. All of these systems have conductive connections to the interior of the

building along which partial lightning currents can flow and disturb or even destroy the sensitive electric/electronic equipment. The isolated air-termination system prevents this transfer of partial lightning currents into the building. The HVI light Conductor is the right system for maintaining the separation distance on flat roofs. The high-voltage-resistant, insulated HVI light Conductor prevents uncontrolled flashover to metal or electric components underneath the roofing.

The HVI light Conductor is available on a 100 m disposable reel (diameter approx. 800 mm, width approx. 485 mm) or on a 500 m disposable reel (diameter approx. 1 m, width approx. 670 mm) for the installer to cut to length on site or is already cut to length (6 - 70 m).

- high-voltage-resistant, insulated HVI light Conductor for maintaining the separation distance to electrically conductive parts according to IEC 62305-3
- equivalent separation distance $s \leq 0.45$ m (in air) or $s \leq 0.90$ m (solid material)

Technical data	HVI light Conductor (on a reel)	HVI light Conductor (cut to length)
Structure	solid	solid
Cross section of the inner conductor (Cu)	19 mm ²	19 mm ²
Colour of conductor	dark grey	dark grey
Outer diameter	20 mm	20 mm
Equivalent separation distance (air)	≤ 45 cm	≤ 45 cm
Equivalent separation distance (solid material)	≤ 90 cm	≤ 90 cm
Minimum bending radius (OD = outer diameter)	10 x OD, min. 200 mm	10 x OD, min. 200 mm
Operating temperature	-30 °C ... +70 °C	-30 °C ... +70 °C
Installation temperature	-5 °C ... +40 °C	-5 °C ... +40 °C
Tensile strength	950 N	950 N
UV / weather-resistant	yes	yes
Tested with I_{imp} (10/350 μs) based on EN 62561-1	150 kA	150 kA
For use in class of LPS in case of a single down conductor without current distribution ($k_c = 1$)	II, III, IV	II, III, IV
Installation in Ex zone 1 and 21	not allowed	not allowed
Minimum order quantity	100 m	≥ 6 m
Max. order length	—	70 m
Cable weight / 100 m	~ 40 kg	—

Partly isolated lightning protection system for an administration building

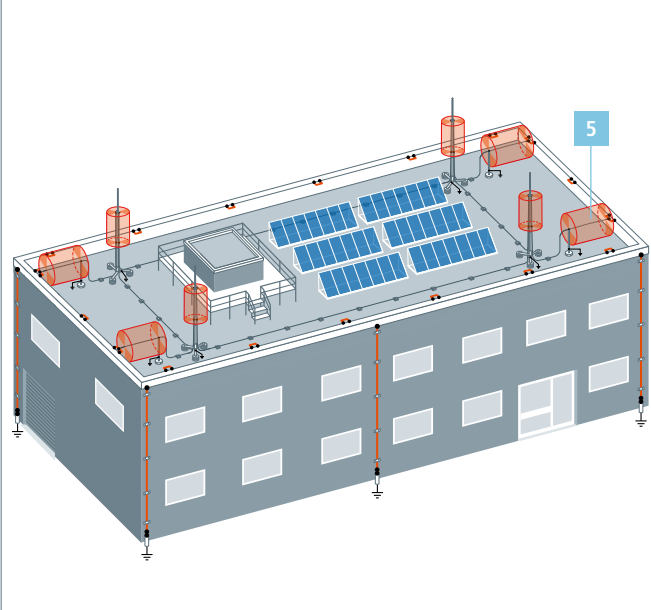

Isolated lightning protection system for an administration building

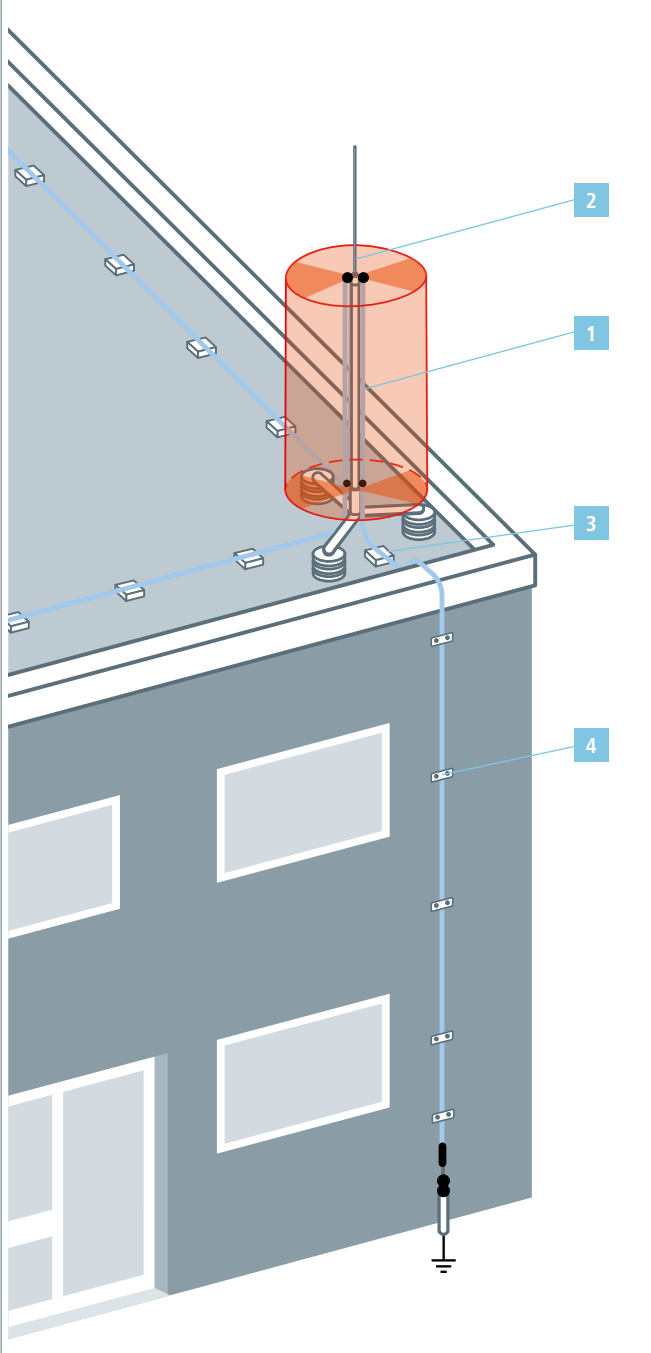

Product	Product name
<p>1</p> 	<p>HVI light Conductor Connection Elements</p> <p>see page 144</p>
<p>2</p> 	<p>Air-termination Masts for HVI light Conductor</p> <p>see page 145</p>
<p>3</p> 	<p>Conductor Holders for Installation on Flat Roofs / Metal Roofs</p> <p>see page 147</p>
<p>4</p> 	<p>Wall-Mounted Conductor Holders</p> <p>see page 150</p>
<p>5</p> 	<p>Adjustment Range</p> <p>see page 152</p>



1 HVI light Conductor

System for maintaining the separation distance, e.g. on flat roofs. The high-voltage-resistant, insulated HVI light Conductor prevents uncontrolled flashover to metal or electric components underneath the roofing. For use up to an equivalent separation distance $s \leq 45$ cm (in air) or $s \leq 90$ cm (solid material).

HVI light Conductor (on a reel)

The HVI light Conductor comes in a length of 100 m on a disposable plywood reel (diameter approx. 800 mm, width approx. 485 mm). Allen key included in delivery.



Part No.	819 125
Material of conductor	Cu
Material of insulation	PE
Material of sheath	PVC
Colour of conductor	dark grey ●
Cross section of core	19 mm ²
Diameter Ø conductor	20 mm
PU	100 m

HVI light Conductor (500 m on a reel)

HVI light Conductor comes in a length of 500 m on a disposable plywood reel (diameter approx. 1 m, width approx. 670 mm). Allen key included in delivery. Total weight approx. 290 kg.



NEW

Part No.	819 124 ^{NEW}
Material of conductor	Cu
Material of insulation	PE
Material of sheath	PVC
Colour of conductor	dark grey ●
Cross section of core	19 mm ²
Diameter Ø conductor	20 mm
PU	500 m

HVI light Conductor (cut to length)

The cut-to-length HVI light Conductor is supplied in a cardboard box (max. 70 m). Please state conductor length when ordering (0.5 m steps).



Part No.	819 129
Material of conductor	Cu
Material of insulation	PE
Material of sheath	PVC
Colour of conductor	dark grey ●
Cross section of core	19 mm ²
Diameter Ø conductor	20 mm
Minimum order length	6 m
PU	1 pc(s)



1 Connection Elements for HVI light Conductors

Connection element for HVI light Conductor

Connection element for connecting the HVI light Conductor to other parts of the external lightning protection system or earth-termination system. Heat-shrinkable sleeve included.



Part No.	819 299
Material	StSt
Connection	bolt Ø10 mm, L 50 mm
Design	with spring washer
Screw	threaded bolt M6 x 8 mm
PU	1 pc(s)

EB connection element for HVI light Conductor

For discharging the electrical field in the sealing end range of the HVI light Conductor. Specially slotted design for electrically contacting the semi-conductive sheath.



Part No.	410 219
Material	StSt
Clamping range Ø	17 mm
Connection hole Ø	11 mm
Screw	☒ M10 x 20 mm
PU	1 pc(s)

HVI light Conductor

Fixing kit for HVI light Conductor

Fixing kit for mounting the HVI light Conductor on the supporting tube $\varnothing 50$ mm (e.g. HVI long supporting tube), consisting of a connection plate (for four conductors, incl. two self-locking nuts) and a fixing ring with four slotted conductor holders ($\varnothing 17$ mm) for the adjustment range (incl. two cable ties).

Part No.	819 289
Material	StSt / Al
Connection plate support	square hole 13 mm
PU	1 pc(s)

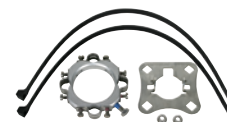

Fixing bolt

Fixing bolt for spanning cables to an air-termination rod ($\varnothing 22$ / $\varnothing 16$ mm) or to a connection plate (e.g. Part No. 819 289 or 819 288).

Part No.	105 229
Material	Al
Connection	1x W 11 mm, 1x W 23 mm
Screw	☒ M8 x 10 ☒ M12 x 20 mm
Wire end ferrule	50 mm ²
Material of wire end ferrule	Cu/Sn
PU	10 pc(s)



Accessory for Connection Elements for HVI light Conductors

Wire end ferrule

Wire end ferrule with a cross-section of 50 mm² for securely fixing the aluminium cable (Part No. 840 050).
1 set = 10 pieces

Part No.	444 050
Material	Cu/Sn
Cross section	50 mm ²
PU	1 set



2 Air-termination Masts for HVI light Conductors on Flat Roofs

Includes connection plate for four HVI light Conductors and fixing kit for mounting the conductors on the air-termination mast. Adjustable to roof inclination up to max. 10°. Concrete bases (weight 17 kg) and base plates have to be ordered separately.

Air-termination mast 30 for HVI light Conductor SET I (total height 2300 mm)

Part No.	819 282
Material of tripod	St/tZn
Radius of tripod	320 mm
Material of supporting tube	GRP / Al
Length of supporting tube	1300 mm
Insulating clearance	1095 mm
Length of air-termination tip	1000 mm
Material of air-termination tip	StSt
Max. gust wind speed (3 blocks, 17 kg each)	154 km/h
PU	1 pc(s)

Air-termination mast 30 for HVI light Conductor SET II (total height 2800 mm)

Part No.	819 287
Material of tripod	St/tZn
Radius of tripod	320 mm
Material of supporting tube	GRP / Al
Length of supporting tube	1300 mm
Insulating clearance	1095 mm
Length of air-termination tip	1500 mm
Material of air-termination tip	Al
Max. gust wind speed (3 blocks, 17 kg each)	132 km/h
PU	1 pc(s)





Air-termination mast 50 for HVI light Conductor SET I (total height 2900 mm)

Part No.	819 380
Material of tripod	St/tZn
Radius of tripod	560 mm
Material of supporting tube	GRP / Al
Length of supporting tube	1900 mm
Insulating clearance	1535 mm
Length of air-termination tip	1000 mm
Material of air-termination tip	StSt
Max. gust wind speed (3 blocks, 17 kg each)	124 km/h
Max. gust wind speed (6 blocks, 17 kg each)	168 km/h
Max. gust wind speed (9 blocks, 17 kg each)	204 km/h
PU	1 pc(s)

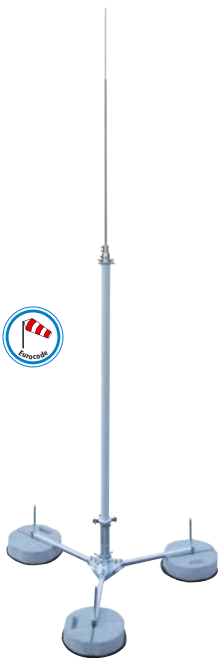

Air-termination mast 50 for HVI light Conductor SET II (total height 3900 mm)

Part No.	819 385
Material of tripod	St/tZn
Radius of tripod	560 mm
Material of supporting tube	GRP / Al
Length of supporting tube	1900 mm
Insulating clearance	1535 mm
Length of air-termination rod	2000 mm
Material of air-termination rod	Al
Max. gust wind speed (3 blocks, 17 kg each)	113 km/h
Max. gust wind speed (6 blocks, 17 kg each)	147 km/h
Max. gust wind speed (9 blocks, 17 kg each)	179 km/h
PU	1 pc(s)



Air-termination mast 50 for HVI light Conductor SET III (total height 4900 mm)

Part No.	819 390
Material of tripod	St/tZn
Radius of tripod	560 mm
Material of supporting tube	GRP / Al
Length of supporting tube	1900 mm
Insulating clearance	1535 mm
Length of air-termination rod	3000 mm
Material of air-termination rod	Al
Max. gust wind speed (3 blocks, 17 kg each)	99 km/h
Max. gust wind speed (6 blocks, 17 kg each)	129 km/h
Max. gust wind speed (9 blocks, 17 kg each)	147 km/h
PU	1 pc(s)

3 Conductor Holders and Accessories for Installation on Flat Roofs / Metal Roofs

Note: Please contact us to find out whether the material of roof conductor holder or base plate is compatible with the roof elements.

Roof conductor holder for flat roofs

For fixing round conductors and strips on flat roofs with one conductor support type FB.

Part No.	253 015
Conductor routing	loose
Material of conductor holder	plastic
Conductor support Rd	8 mm
Block	concrete (C35/45)
Weight	1 kg
PU	10 pc(s)



Adapter for installing the HVI light Conductor / HVI Conductor on flat roofs

To be snapped on roof conductor holder type FB (Part No. 253 015).

Part No.	253 026
Material	plastic
Colour	black ●
Conductor support Rd	20 mm
PU	50 pc(s)



Roof conductor holder

For flat roofs, weight approx. 4.7 kg.

Conductor holder, concrete block and base plate for installing the HVI light Conductor, HVI Conductor on flat roofs.

Part No.	253 229
Material of conductor holder	StSt
Conductor support Rd	20 / 23 mm
Total weight	approx. 4.7 kg
PU	1 pc(s)



Conductor holder

Conductor holder with slotted saddle clamp for HVI light Conductor, HVI Conductor for fixing in the base plate (Part No. 253 300) with concrete block (Part No. 253 301).

Part No.	253 289
Material	StSt
Conductor support Rd	20 / 23 mm
Height of conductor holder	87 mm
Bolt	Ø10 mm (push-fit)
PU	1 pc(s)



Concrete block

For stabilising the base plate.

Part No.	253 301
Material	concrete (C35/45)
Weight	4.6 kg
Dimensions	180 x 180 x 70 mm
PU	24 pc(s)



Base plate

Base plate to hold the spacer bar (Part No. 253 315, 253 325) and conductor holder (Part No. 253 289) and to protect the roof sheeting under the concrete block (Part No. 253 301).

Part No.	253 300
Diameter Ø	300 mm
Diameter Ø of lock bush	10 mm
Height	60 mm
Material	plastic
Colour	grey ●
PU	24 pc(s)



Roof conductor holder

For flat roofs, weight approx. 8.6 kg.

Conductor holder, concrete block and base plate, for installing the HVI light Conductor, HVI Conductor on flat roofs.

Part No.	253 239
Material of conductor holder	StSt
Conductor support Rd	20 / 23 mm
Total weight	approx. 8.6 kg
PU	1 pc(s)



Conductor holder

Conductor holder with slotted saddle clamp for HVI light Conductor, HVI Conductor for fixing in the concrete base (Part No. 102 075) with fixing wedge.

Part No.	253 279
Material	StSt
Conductor support Rd	20 / 23 mm
Height of conductor holder	125 mm
Bolt	Ø16 mm (wedge-fit)
PU	1 pc(s)

Concrete base

With fixing wedge, for air-termination tips Ø10, length 1000 mm or DEHNiso spacers Ø16 mm, length up to 675 mm (distance 0.8 m) or conductor holder (Part No. 253 279).



Part No.	102 075
Total weight	8.5 kg
Diameter Ø	240 mm
Material	concrete (C45/55)
Material of wedge / adapter	StSt
PU	120 pc(s)

Base plate

To protect the roof sheeting under the concrete base. For concrete bases (Part No. 102 075, 102 003).



Part No.	102 060
Outside diameter Ø	280 mm
Inside diameter Ø	270 mm
Material	EVA
Colour	black ●
PU	1 pc(s)

Spacers for HVI light Conductor

Spacer for implementing the adjustment range (length 1200 mm) without additional connection to the equipotential bonding. The spacer is installed, e.g. in a concrete block with fixing wedge (17 kg) (Part No. 102 340).



Part No.	106 852	106 812
Material of spacer	GRP	GRP
Material of conductor holder / adapter	PA	PA
Length	500 mm	1000 mm
Conductor support Rd	20 mm	20 mm
Thread	M8	M8
Max. gust wind speed (1x block 17 kg, holder distance 1000 mm)	154 km/h	98 km/h
PU	1 pc(s)	1 pc(s)

Spacer with EB element for HVI light Conductor (length of variable adjustment range 350-900 mm)

Spacer for implementing the variable adjustment range of the HVI light Conductor.

With MV clamp for connection to the equipotential bonding (Rd 16 mm / Rd 8-10 mm).

Concrete base (Part No. 102 010, weight 17 kg) and base plate (Part No. 102 050) must be ordered separately.



Part No.	105 460
Material of spacer	Al
Length of spacer	750 mm
Conductor support Rd	17 mm
Material of conductor holder	StSt
Clamping range Rd MV clamp	8-10 / 16 mm
Material of clamp	Al
Length of variable adjustment range	350-900 mm
Max. gust wind speed (1 base, 17 kg each; l = 900 mm)	111 km/h
Max. gust wind speed (2 bases, 17 kg each; l = 900 mm)	159 km/h
PU	1 pc(s)

Concrete base

With fixing wedge and adapted base plate, stackable.



Part No.	102 340
Total weight	17 kg
Support	with fixing wedge Ø16 mm
Diameter Ø	337 mm
Material	concrete (C45/55)
Material of wedge	StSt
PU	54 pc(s)

Concrete base

With fixing wedge, stackable, for erecting tripods and air-termination rods Ø16 mm, chamfered or tapered, DEHNiso spacer Ø16 mm or conductor holder (Part No. 253 279).

Part No.	102 010
Weight	17 kg
Support	with fixing wedge Ø16 mm
Diameter Ø	337 mm
Material	concrete (C45/55)
Material of wedge / adapter	StSt
PU	54 pc(s)



Base plate

To protect the roof sheeting under the concrete base.
For concrete bases (Part Nos. 102 010, 102 002).

Part No.	102 050
Outside diameter Ø	370 mm
Inside diameter Ø	360 mm
Material	EVA
Colour	black ●
PU	1 pc(s)



Roof conductor holders for roofs with round standing seam

Roof conductor holder with slotted saddle clamp for fixing the HVI light Conductor, HVI Conductor on metal roofs with round standing seam.

Part No.	202 850
Material of roof conductor holder	StSt
Material of conductor holder	StSt
Clamping range	Ø20-25 mm
Conductor support Rd	20 / 23 mm
Standard	EN 62561-4
PU	25 pc(s)



Roof conductor holder for roofs with clamping seam (e.g. RIB-ROOF Speed 500 from Zambelli)

Roof conductor holder with slotted saddle clamp for fixing the HVI light Conductor, HVI Conductor on metal roofs with clamping seam.

Part No.	202 851
Material of roof conductor holder	StSt
Material of conductor holder	StSt
Clamping range	approx. 18 / 22 mm
Conductor support Rd	20 / 23 mm
Standard	EN 62561-4
PU	25 pc(s)



Roof conductor holder for roofs with standing seam

Roof conductor holder with slotted saddle clamp for fixing the HVI light Conductor, HVI Conductor on metal roofs with standing seam.

Part No.	202 852
Material of roof conductor holder	StSt
Material of conductor holder	StSt
Clamping range	0.7-8 mm
Conductor support Rd	20 / 23 mm
Standard	EN 62561-4
PU	25 pc(s)



Roof conductor holder with connection lug

Roof conductor holder with slotted saddle clamp and Z-shaped connection lug (for riveting or screwing), for fixing the HVI light Conductor, HVI Conductor on metal roofs.

Part No.	202 853
Material of roof conductor holder	StSt
Material of conductor holder	StSt
Fixing	[4x] Ø5.2 / [2x] Ø6.5 mm
Conductor support Rd	20 / 23 mm
Standard	EN 62561-4
PU	25 pc(s)



4 Wall-Mounted Conductor Holders

HVI light Conductor

Conductor holder

With thread.

Wall-mounted conductor holder with two-screw clamp (not for use in the sealing end range).



Part No.	275 250	275 251
Material of conductor holder	StSt	StSt
Conductor support Rd	20 / 23 mm	20 / 23 mm
Thread	M8	M6
Standard	EN 62561-4	EN 62561-4
PU	25 pc(s)	25 pc(s)

Conductor holder

With slotted hole.

Wall-mounted conductor holder with two-screw clamp (not for use in the sealing end range).



Part No.	275 252
Material of conductor holder	StSt
Conductor support Rd	20 / 23 mm
Fixing hole	5.5 x 10 mm
Standard	EN 62561-4
PU	25 pc(s)

Conductor holder

With plastic base.

Wall-mounted conductor holder with two-screw clamp (not for use in the sealing end range).



Part No.	275 259
Material of conductor holder	StSt
Conductor support Rd	20 / 23 mm
Thread	M8
Standard	EN 62561-4
PU	25 pc(s)

Conductor holder for HVI Conductor

For mounting on walls and in the sealing end range.



Part No.	275 220
Material of conductor holder	PA
Conductor support Rd	20 mm
Female thread	M8
Fixing hole	6.5 mm
PU	25 pc(s)

Stripping tool for HVI light Conductors / HVI Conductors



Tool for stripping the semi-conductive sheath and the PE insulation of the HVI light Conductor, HVI Conductor (outer diameter 20 mm).

- Tool consists of a handle and various exchangeable cutting heads
- Stripping length of HVI light Conductor, HVI Conductor is adjustable in steps of 0.2 mm (lock points) using the knob in the handle. The dial on the handle shows the length set.

Handling

Position the cutting head at the cut-off end of the conductor and turn clockwise with light pressure to cut/strip it. The cutting head can be exchanged without tools via the bayonet coupling.

HVI strip 20

For HVI light and HVI Conductors (handle + cutting head).



Part No.	597 220
Diameter Ø conductor	20 mm
Material of moulded part	plastic
Material of blade	StSt
PU	1 pc(s)

HVI light Conductor

HVI head 20

For HVI light and HVI Conductors (cutting head).

Part No.	597 120
Diameter Ø conductor	20 mm
Material of moulded part	plastic
Material of blade	StSt
PU	1 pc(s)



Accessories for Stripping tool for HVI light Conductors / HVI Conductors

HVI head holder

Adapter with bayonet coupling for attaching the HVI head cutting head (pre-set stripping length 35 mm). Adapter can be used in a standard three-jaw chuck (Ø10 mm), e.g. with cordless screwdrivers.

Part No.	597 139
Material	plastic / brass
PU	1 pc(s)



Spare blades for HVI head 20

1 set = 4 blades

Part No.	597 101
Material	StSt
PU	1 set



Stripping Tool for HVI light Conductors / HVI Conductors

Tool for stripping the additional grey sheath of the HVI light Conductor and HVI Conductor. DEHNhelix consists of a handle and an exchangeable bracket (depending on the conductor diameter).

DEHNhelix

Part No.	597 230
Diameter Ø conductor	23 mm
Material of moulded part	plastic
Material of blade	StSt
PU	1 pc(s)



Accessory for Stripping Tool for HVI light Conductors / HVI Conductors

Spare blade for stripping tool

Part No.	597 130
Material	StSt
PU	1 pc(s)



Cable shears for HVI Conductors

Cable shears for easily cutting the HVI light Conductor, HVI Conductor (outer diameter 20 / 23 mm), HVI power Conductor (outer diameter 27 mm) and CUI Conductor to length.

The special design of the cable shears also allows precise cutting of stranded conductors, making it easier to attach connection elements.



HVI cutter

Part No.	597 032
Diameter Ø conductor	up to 32 mm
Material of blades	tool steel (CR-Moly (SCM440))
Material of handles	carbon steel (SS400)
Length	600 mm
PU	1 pc(s)



5 Adjustment Range, Separation Distance $s \leq 45$ cm

Connection of the HVI light Conductor to an existing lightning protection system. The equivalent separation distance s at the connection point of the HVI light Conductor is ≤ 45 cm (in air). In the connection area an adjustment range around the HVI light Conductor has to be provided. No electrical, conductive or earthed parts may be installed in this area. This is necessary in order to couple the lightning current safely into the conductor. An equipotential bonding connection is not necessary.

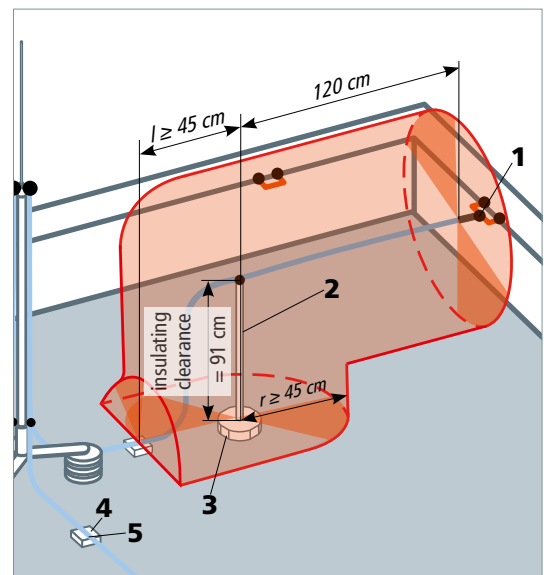
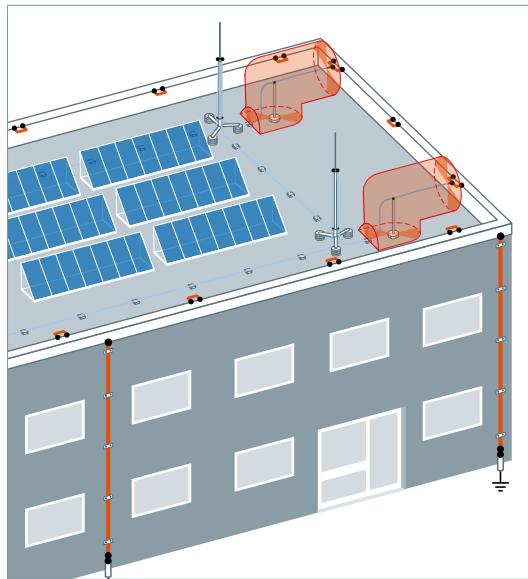

Accessories for the Adjustment Range, Separation Distance $s \leq 45$ cm

Connection element for HVI light Conductor

Connection element for sealing and connecting the HVI light Conductor to other parts of the external lightning protection system or earth-termination system. Heat-shrinkable sleeve included.



Part No.	819 299
PU	1 pc(s)

Spacers for HVI light Conductor

Spacer for implementing the adjustment range (length 1200 mm) without additional connection to the equipotential bonding. The spacer is installed, e.g. in a concrete block with fixing wedge (17 kg) (Part No. 102 340).



Part No.	106 812
PU	1 pc(s)

Concrete base

With fixing wedge and adapted base plate, stackable.



Part No.	102 340
PU	54 pc(s)

Roof conductor holder for flat roofs

For fixing round conductors and strips on flat roofs with one conductor support type FB.



Part No.	253 015
PU	10 pc(s)

Adapter for installing the HVI light Conductor / HVI Conductor on flat roofs

To be snapped on roof conductor holder type FB (Part No. 253 015).



Part No.	253 026
PU	50 pc(s)

5 Variable Adjustment Range, Connection to "Isolated Ring Conductor"

If several installation parts require protection, it is advisable not to route the HVI light Conductor of each air-termination system individually to the earth-termination system. The HVI light Conductors from the air-termination system can be connected to an "isolated ring conductor". From this "isolated ring conductor" several down conductors, HVI light Conductors, can then be led to the earth-termination system. The "isolated ring conductor" must be installed, e.g. on the roof, on spacers and concrete bases, taking the calculated separation distance "s" into account.

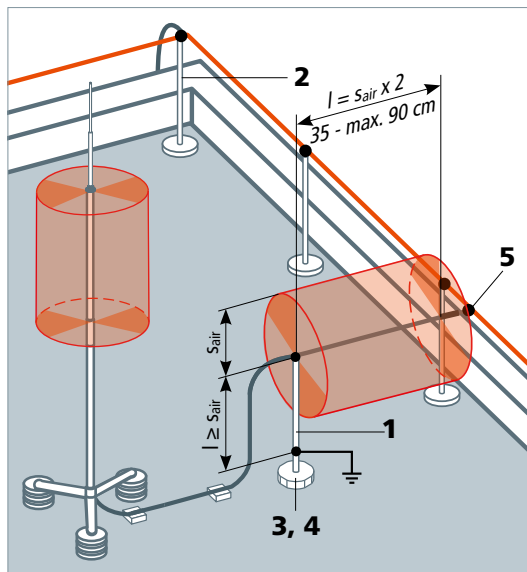
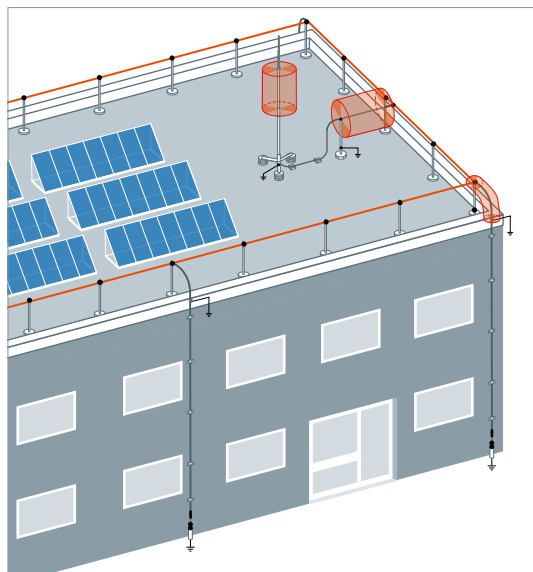

Accessories for the Variable Adjustment Range, Connection to "Isolated Ring Conductor"

Spacer with EB element for HVI light Conductor (length of variable adjustment range 350-900 mm)

Spacer for implementing the variable adjustment range of the HVI light Conductor. With MV clamp for connection to the equipotential bonding (Rd 16 mm / Rd 8-10 mm). Concrete base (Part No. 102 010, weight 17 kg) and base plate (Part No. 102 050) must be ordered separately.

Part No.	105 460
PU	1 pc(s)



DEHNiso spacers with MMV clamp

For crossing points, when installed in a concrete base (Part No. 102 075), fixed conductor routing.

Part No.	106 150
PU	1 pc(s)



Concrete base

With fixing wedge, stackable, for erecting tripods and air-termination rods Ø16 mm, chamfered or tapered, DEHNiso spacer Ø16 mm or conductor holder (Part No. 253 279).

Part No.	102 010
PU	54 pc(s)



Base plate

To protect the roof sheeting under the concrete base. For concrete bases (Part Nos. 102 010, 102 002).

Part No.	102 050
PU	1 pc(s)



MV clamp

With hexagon screw, spring washer and thread in the base part. Lightning current carrying capability 200 kA (10/350 µs).

Part No.	390 209
PU	1 pc(s)



5 Variable Adjustment Range, Connection to "Capping of Roof Parapet"

If several installation parts require protection, it is advisable not to route the HVI light Conductor of each air-termination system individually to the earth-termination system. The HVI Conductors from the air-termination system can be connected to the capping of a roof parapet which serves as "isolated ring conductor". From this capping, several down conductors can then be routed to the earth-termination system.

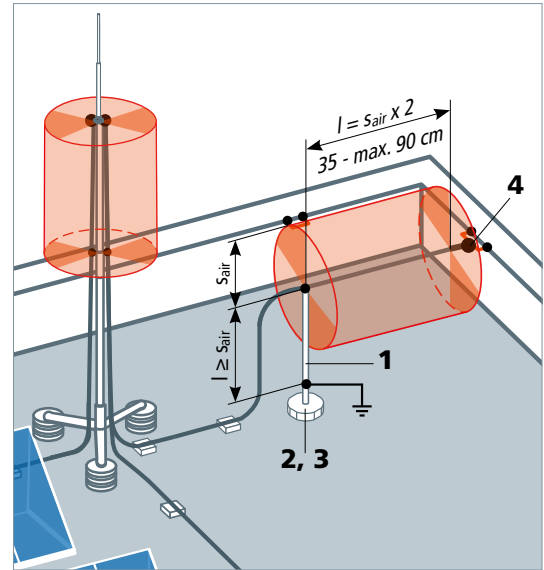
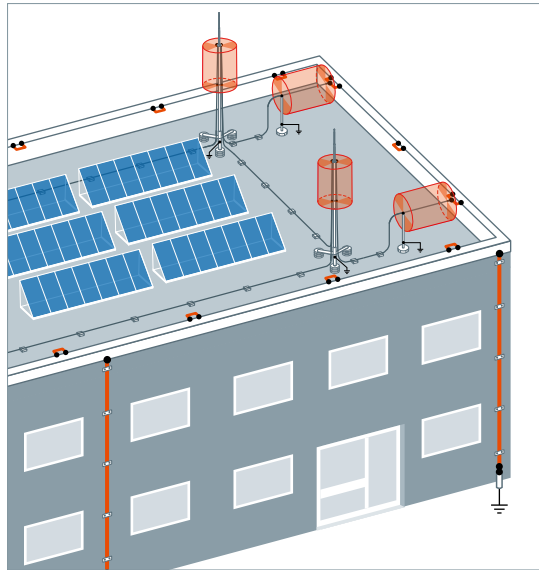

Accessories for the Variable Adjustment Range, Connection to "Capping of Roof Parapet"



1 Spacer with EB element for HVI light Conductor (length of variable adjustment range 350-900 mm)
 Spacer for implementing the variable adjustment range of the HVI light Conductor.
 With MV clamp for connection to the equipotential bonding (Rd 16 mm / Rd 8-10 mm).
 Concrete base (Part No. 102 010, weight 17 kg) and base plate (Part No. 102 050) must be ordered separately.

Part No.	105 460
PU	1 pc(s)



2 Concrete base
 With fixing wedge, stackable, for erecting tripods and air-termination rods Ø16 mm, chamfered or tapered, DEHNiso spacer Ø16 mm or conductor holder (Part No. 253 279).

Part No.	102 010
PU	54 pc(s)



3 Base plate
 To protect the roof sheeting under the concrete base. For concrete bases (Part Nos. 102 010, 102 002).

Part No.	102 050
PU	1 pc(s)



4 KS connector
 With M10 screw and nut. Lightning current carrying capability 200 kA (10/350 µs).

Part No.	301 209
PU	1 pc(s)



The installation of bare, uninsulated conductors can pose a problem with regard to proximity, particularly in residential and low buildings. Here, it is usually not possible to consistently maintain the separation distance. Requirements for maintaining of the separation distance are specified in the lightning protection standard IEC 62305 and also in communication technology standards. IEC 60728-11 points out that radio masts on buildings with a lightning protection system should be separately integrated in this system. DEHNcon-H is ideally suited for this application.

- Optically optimised design since the HVI / HVI light Conductor is installed in the supporting tube, reduced dimensions of the supporting tubes and low weight of the whole structure, also suitable for retrofitting on existing antenna poles
- High-voltage-resistant, insulated down conductor for keeping the separation distance from electrically conductive parts according to IEC 62305-3
- Supporting tube with insulating clearance made of glass-fibre reinforced plastic (GRP)
- Colour light grey, UV-stabilised

Isolated lightning protection system of a residential building

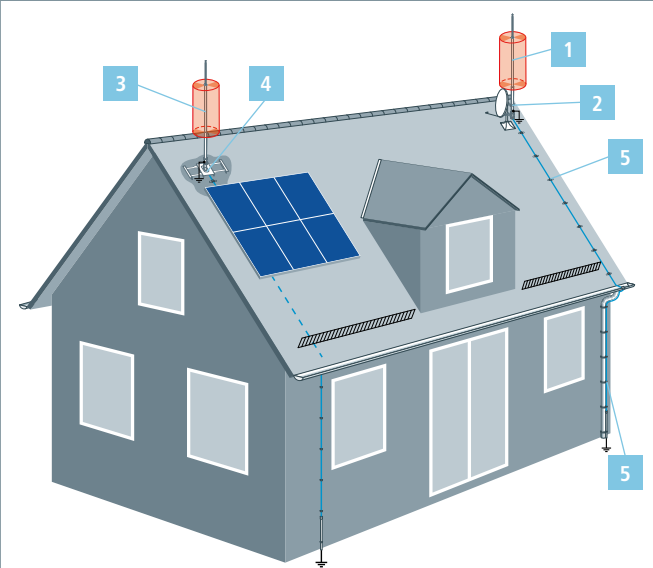

Residential building / sub-roof installation

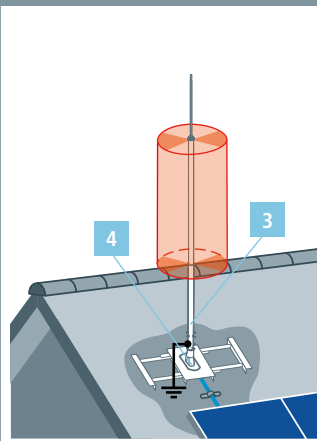

Residential building / rooftop installation

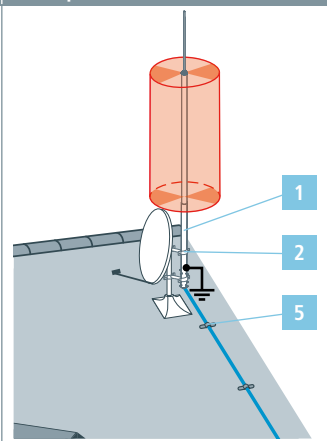

Product	Product name
	<p>Supporting Tubes with HVI light Conductor for rooftop Installation</p> <p>HVI light Conductor Connection Elements</p> <p>see page 156</p>
	<p>Fixing Elements for Supporting Tubes</p> <p>see page 157</p>
	<p>Supporting Tubes for HVI / HVI light Conductors for sub-roof Installation</p> <p>Supporting Tubes Connection Elements</p> <p>see page 159</p>
	<p>Mounting Bracket for Installation on Rafters</p> <p>Roof Bushing Kit</p> <p>see page 161</p>
	<p>Conductor Holder for HVI / HVI light Conductors</p> <p>see page 163</p>

1 2 DEHNcon-H



Isolated air-termination system for transmitters/receivers (parabolic, terrestrial antennas) or whole buildings or parts of a building. Optically optimised design since the HVI light Conductor is installed inside the supporting tube, reduced dimensions of the supporting tubes (Al tube 40 x 5 mm / GRP tube 30 x 3 mm) and low weight of the whole structure, also suitable for retrofitting on existing antenna poles. Special internal sealing end with a flexible StSt strip is led out at the bottom end of the supporting tube for connection to the equipotential bonding system.

HVI light Conductor inside the supporting tube with air-termination tip

With internal sealing end and air-termination tip StSt Ø10 mm.

General technical data:			
Material of supporting tube	GRP / Al		
Material of conductor	Cu		
Equivalent separation distance s (air)	≤ 45 cm		
Min. clamping length	600 mm		
Part No.	819 255	819 256	819 257
Length of supporting tube	1990 mm	1990 mm	2640 mm
Length of air-termination tip	500 mm	1000 mm	500 mm
Minimum order length	6 m	6 m	6 m
Max. gust wind speed	232 km/h	198 km/h	232 km/h
Max. free length	1890 mm	2390 mm	2540 mm
PU	1 pc(s)	1 pc(s)	1 pc(s)
Part No.	819 258	819 259	
Length of supporting tube	2640 mm	5040 mm	
Length of air-termination tip	1000 mm	500 mm	
Minimum order length	6 m	7.5 m	
Max. gust wind speed	198 km/h	148 km/h	
Max. free length	3040 mm	4940 mm	
PU	1 pc(s)	1 pc(s)	



1 HVI light Conductor



System for maintaining the separation distance, e.g. on flat roofs. The high-voltage-resistant, insulated HVI light Conductor prevents uncontrolled flashover to metal or electric components underneath the roofing.

For use up to an equivalent separation distance $s \leq 45$ cm (in air) or $s \leq 90$ cm (solid material).

HVI light Conductor (on a reel)

The HVI light Conductor comes in a length of 100 m on a disposable plywood reel (diameter approx. 800 mm, width approx. 485 mm). Allen key included in delivery.



Part No.	819 125
Material of conductor	Cu
Material of insulation	PE
Material of sheath	PVC
Colour of conductor	dark grey ●
Cross section of core	19 mm ²
Diameter Ø conductor	20 mm
PU	100 m

HVI light Conductor (500 m on a reel)

HVI light Conductor comes in a length of 500 m on a disposable plywood reel (diameter approx. 1 m, width approx. 670 mm). Allen key included in delivery. Total weight approx. 290 kg.



Part No.	819 124 ^{NEW}
Material of conductor	Cu
Material of insulation	PE
Material of sheath	PVC
Colour of conductor	dark grey ●
Cross section of core	19 mm ²
Diameter Ø conductor	20 mm
PU	500 m

HVI light Conductor (cut to length)

The cut-to-length HVI light Conductor is supplied in a cardboard box (max. 70 m). Please state conductor length when ordering (0.5 m steps).

Part No.	819 129
Material of conductor	Cu
Material of insulation	PE
Material of sheath	PVC
Colour of conductor	dark grey ●
Cross section of core	19 mm ²
Diameter Ø conductor	20 mm
Minimum order length	6 m
PU	1 pc(s)



DEHNcon-H Supporting Tubes for HVI light Conductor

Supporting tubes for the HVI light Conductor for on-site assembly, air-termination tip, StSt, Ø10 mm.

With air-termination tip

Part No.	105 272	105 273	105 274	105 280
Material of supporting tube	GRP / Al	GRP / Al	GRP / Al	GRP / Al
Length of supporting tube	1990 mm	1990 mm	2640 mm	2640 mm
Length of air-termination tip	500 mm	1000 mm	500 mm	1000 mm
Outside diameter Ø GRP	30 mm	30 mm	30 mm	30 mm
Outside diameter Ø Al (clamping range)	40 mm	40 mm	40 mm	40 mm
Max. gust wind speed	232 km/h	198 km/h	232 km/h	198 km/h
Max. free length	1890 mm	2390 mm	2540 mm	3040 mm
Min. clamping length	600 mm	600 mm	600 mm	600 mm
PU	1 pc(s)	1 pc(s)	1 pc(s)	1 pc(s)



Connection Elements for DEHNcon-H, HVI light Conductor

Connection kit for supporting tube (Part Nos. 105 272 and 105 273)

Connection kit for sealing the HVI light Conductor at both ends, for implementing the adjustment range of the conductor in the supporting tube (head piece) and connection element for other parts of the external lightning protection system or earth-termination system (incl. EB connection cable, constant force spring and three heat-shrinkable sleeves).

Part No.	819 271
Material of connection elements	StSt
Connection	bolt Ø10 mm, L 50 mm
Diameter Ø connection element	20 mm
EB connection cable	strip 1000 x 18 x 0.4 mm
PU	1 pc(s)



Connection kit for supporting tube (Part Nos. 105 274 and 105 280)

Connection kit for sealing the HVI light Conductor at both ends, for implementing the adjustment range of the conductor in the supporting tube (head piece) and connection element for other parts of the external lightning protection system or earth-termination system (incl. EB connection cable, constant force spring and three heat-shrinkable sleeves).

Part No.	819 272
Material of connection elements	StSt
Connection	bolt Ø10 mm, L 50 mm
Diameter Ø connection element	20 mm
EB connection cable	strip 2200 x 18 x 0.4 mm
PU	1 pc(s)



Accessories for DEHNcon-H

Fixing clamp for DEHNcon-H

Clamp for fixing the supporting tube, e.g. on the antenna pole. With spacer, length 30 mm for adjusting antenna holders.

Part No.	105 161
Material	StSt
Clamping range of pipe Ø	45-65 mm (1 1/2-2")
Clamping range of supporting tube	40-50 mm
Length of spacer	30 mm
PU	1 pc(s)



Wall mounting bracket for vertical mounting

For attaching supporting tubes or air-termination rods D40 / D50 to roof-mounted structures or walls.



Part No.	105 342	105 348
Material of bracket	StSt	StSt
Fixing	[8x] Ø5.1 / [4x] 7 x 10 / [2x] 11 x 20 mm	[8x] Ø5.1 / [4x] 7 x 10 / [2x] 11 x 20 mm
Clamping range for supporting tube	40-50 mm	40-50 mm
Distance from wall	46 mm	110 mm
PU	1 pc(s)	1 pc(s)

Wall mounting bracket for horizontal mounting, flat

For attaching DEHNcon-H supporting tubes to the structure to be protected or the wall.



Part No.	105 140
Material	StSt
Fixing	[8x] Ø5.1 / [4x] 11 x 20 mm
Distance from wall	80 mm
Clamping range of air-termination rod	40 mm
PU	1 pc(s)

Railing clamp

For pipes.



Part No.	105 354
Material	StSt
Clamping range for pipe Ø	48-60 mm (1 1/2-2")
Clamping range for supporting tube	40-50 mm
PU	5 pc(s)

Wall mounting bracket, adjustable from 150-200 mm

For attaching supporting tubes or air-termination rods D40 / D50, with double clamp for connecting 2x Rd 8-10 mm.

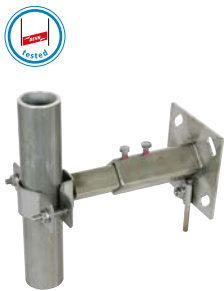

Part No.	105 344
Material of bracket	StSt
Clamping range for supporting tube	40-50 mm
Distance from wall	150-200 mm
Dimensions of plate	120 x 120 x 4 mm
Fixing	[4x] 12 x 26 mm
Standard	EN 62561-1
PU	1 pc(s)

Wall mounting bracket, adjustable from 230-1300 mm

For fixing supporting tubes or air-termination rods D40 / D50.



Part No.	105 347	105 343	105 349
Material of bracket	St/tZn / StSt	St/tZn / StSt	St/tZn / StSt
Clamping range for supporting tube	40-50 mm	40-50 mm	40-50 mm
Distance from wall	230-400 mm	400-700 mm	700-1300 mm
Dimensions of plate	120 x 120 x 4 mm	120 x 120 x 4 mm	120 x 120 x 4 mm
Fixing	[4x] 12 x 26 mm	[4x] 12 x 26 mm	[4x] 12 x 26 mm
PU	1 pc(s)	1 pc(s)	1 pc(s)

Support for air-termination rod D40 and DEHNcon-H

Fixing clamp with tensioning strap.



Part No.	105 160
Material	StSt
Clamping range Ø pipe	50-300 mm
Clamping range of air-termination rod	40-50 mm
Dimensions of strip (w x d)	25 x 0.3 mm
Standard	EN 62561-1
PU	1 pc(s)

Railing clamp

With spacer for adjusting, e.g. antenna holders.



Part No.	105 162
Material	StSt
Clamping range for pipe Ø	45-65 mm (1 1/2-2")
Clamping range for supporting tube	40-50 mm
Length of spacer	95 mm
Standard	EN 62561-1
PU	1 pc(s)

3 Air-termination Mast for Sub-roof Installation of the HVI light Conductor



For installation on the mounting bracket for installation on rafters.

Optically optimised design because the HVI light Conductor is installed inside the supporting tube. The HVI light Conductor is led through the supporting tube of the mounting bracket for installation on rafters and installed in the area of the counter-battens / roof battens.

Advantages:

- Sub-roof installation – invisible
- Only the supporting tube is visible
- No mechanical load, e.g. snow

DEHNcon-H / HVI light Conductor inside the supporting tube with air-termination tip

With internal sealing end and air-termination tip $\varnothing 10$ mm.

PU 1 is the minimum order length of 6 m.

Conductor length to be indicated when ordering (in steps of 0.5 m).

Part No.	819 243
Material of supporting tube	GRP / Al
Length of supporting tube	2875 mm
Length of air-termination tip	1000 mm
Outside diameter \varnothing GRP	30 mm
Diameter \varnothing of conductor	20 mm
Colour of conductor	grey ●
Material of conductor	Cu
Equivalent separation distance s (in air)	≤ 45 cm
Minimum order length	6 m
Max. gust wind speed	160 km/h
PU	1 pc(s)



DEHNcon-H Supporting Tube for HVI light Conductor, Sub-roof Installation

Supporting tube for HVI light Conductor for on-site assembly, air-termination tip, StSt, $\varnothing 10$ mm.

With air-termination tip

Part No.	105 288
Material of supporting tube	GRP / Al
Length of supporting tube	2875 mm
Length of air-termination tip	1000 mm
Outside diameter \varnothing GRP	30 mm
Max. gust wind speed	160 km/h
PU	1 pc(s)



HVI light Conductor



System for keeping the separation distance, e.g. on flat roofs. The high-voltage-resistant, insulated HVI light Conductor prevents uncontrolled flashover to metal or electric components underneath the roofing.

For use up to an equivalent separation distance $s \leq 45$ cm (in air) or $s \leq 90$ cm (solid material).

HVI light Conductor (cut to length)

The cut-to-length HVI light Conductor is supplied in a cardboard box (max. 70 m).

Conductor length has to be stated when ordering (in steps of 0.5 m).

Part No.	819 129
Material of conductor	Cu
Material of insulation	PE
Material of sheath	PVC
Colour of conductor	dark grey ●
Colour RAL	similar to 7000
Cross-section of core	19 mm ²
Equivalent separation distance s (in air)	≤ 45 cm
Diameter \varnothing conductor	20 mm
Characteristics of sheath	UV-stabilised and weather-resistant
Minimum order length	6 m
PU	1 pc(s)





Connection Element for DEHNcon-H, HVI light Conductor

Connection kit for sealing the HVI light Conductor at both ends for implementing the adjustment range of the conductor in the supporting tube (head piece) and connection element for connection to other parts of the external lightning protection or earth-termination system (incl. EB connection cable, constant force spring and three heat-shrinkable sleeves).

Connection kit for HVI light Conductor Ø20 mm for installation inside the supporting tube

Part No.	819 272
Material of connection elements	StSt
Connection	bolt Ø10 mm, L 50 mm
Diameter Ø connection element	20 mm
EB connection cable	strip 2200 x 18 x 0.4 mm
PU	1 pc(s)



Air-termination Mast for Sub-roof Installation of the HVI Conductor

For installation on the mounting bracket for installation on rafters. Optically optimised design because the HVI light Conductor is installed inside the supporting tube. The HVI light Conductor is led through the supporting tube of the mounting bracket for installation on rafters and installed in the area of the counter-battens / roof battens.

Advantages:

- Sub-roof installation – invisible
- Only the supporting tube is visible
- No mechanical load, e.g. snow

DEHNcon-H / HVI Conductor inside the supporting tube with air-termination rod

Part No.	819 247
Material of supporting tube	GRP / Al
Length of supporting tube	1955 mm
Length of air-termination rod	2500 mm
Outside diameter Ø GRP	50 mm
Diameter Ø conductor	20 mm
Colour of conductor	black ●
Material of conductor	Cu
Minimum order length	6 m
Max. gust wind speed	150 km/h
PU	1 pc(s)



DEHNcon-H Supporting Tube for HVI Conductor, Sub-roof Installation

Supporting tube for HVI Conductor for on-site assembly, air-termination rod, Al, Ø22 / 16 / 10 mm.

With air-termination rod

Part No.	105 281
Material of supporting tube	GRP / Al
Length of supporting tube	1955 mm
Length of air-termination rod	2500 mm
Outside diameter Ø GRP	50 mm
Max. gust wind speed	150 km/h
PU	1 pc(s)



HVI Conductor / HVI long Conductor

High-voltage-resistant, insulated down conductor for keeping the separation distance to electrically conductive parts according to IEC/EN 62305-3. Can be used up to an equivalent separation distance $s \leq 75$ cm (in air) or $s \leq 150$ cm (solid material).

HVI long Conductor (cut to length)

The cut-to-length HVI Conductor is delivered in a cardboard box (max. 70 m). Conductor length has to be stated when ordering (0.5 m steps).

Part No.	819 131
Material of conductor	Cu
Material of insulation	PE
Material of sheath	PVC
Colour of conductor	black ●
Diameter Ø conductor	20 mm
Minimum order length	6 m
PU	1 pc(s)



Connection Element for DEHNcon-H, HVI Conductor

Connection elements for sealing the HVI long Conductor on both ends, for implementing the sealing end of the conductor inside of the supporting tube (head piece) and connection element for connection to other parts of the external lightning protection system or earth-termination system (incl. two heat-shrinkable sleeves).

Connection kit for HVI Conductor Ø20 mm for installation inside the supporting tube

Part No.	819 145
Material	StSt
Connection	bolt Ø10 mm, L 50 mm
Diameter Ø connection element	23 mm
Screw	threaded bolt M6 x 8 mm
PU	1 pc(s)



4 Mounting Bracket for Installation on Rafters

For side fixing of the

- DEHNcon-H supporting tube (Ø40 mm)
- HVI Conductor inside the supporting tube (Ø50 mm)
- as well as to attach and fix the supporting tubes and for the sub-roof installation of the HVI Conductor or HVI light Conductor.

Note: Mounting conditions on site must be clarified with the building constructor. More information on max. gust wind speeds can be found at www.dehn-international.com

Part No.	105 240
Material	St/tZn
Adjustment range	600-750 mm
Roof inclination	20-50°
Diameter Ø of supporting tube	48 mm
Fixing screw	8 x 120 mm
PU	1 pc(s)

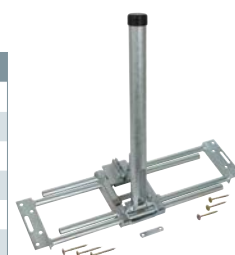

Accessory for Mounting Bracket for Installation on Rafters

Roof bushing kit

- For bushing and sealing of poles and pipes on steep roofs
- Universal use on different roof tiles due to malleable aluminium roof tile

Roof bushing kit comprises aluminium roof tile, rubber grommet and sealing tape.

Part No.	105 245	105 246
Material of roof tile	aluminium, with UV-stabilised plastic coating	aluminium, with UV-stabilised plastic coating
Dimensions of roof tile	450 x 500 mm	450 x 500 mm
Diameter Ø of mast hole	10 / 16 / 48 mm	10 / 16 / 48 mm
Roof inclination	24-53°	24-53°
Material of rubber grommet	UV-stabilised rubber mixture	UV-stabilised rubber mixture
Material of sealing tape	rubber-based plastic sealant	rubber-based plastic sealant
Type of sealing tape	strongly adhesive, self-welding	strongly adhesive, self-welding
Dimensions of sealing tape	600 x 80 mm	600 x 80 mm
Processing temperature	+5 °C ... +40 °C	+5 °C ... +40 °C
Permanent temperature range of sealing tape	-40 °C ... +80 °C	-40 °C ... +80 °C
Colour	black ●	red ●
PU	1 pc(s)	1 pc(s)



4 Mounting Bracket for Air-Termination Systems on Metal Roofs

Mounting bracket (StSt) for installing HVI air-termination systems or air-termination rods on metal roofs: Mounting bracket for vertical mounting of air-termination systems on metal roofs with an inclination of max. 53°. For fixing air-termination rods D40 in place and mounting DEHNcon-H systems, e.g. Part No. 819 243 or 819 247, with the conductor in the supporting tube.

Note: Mounting conditions on site must be clarified with the building constructor. More information on max. gust wind speeds at www.dehn-international.com

Part No.	105 241
Material	StSt
Adjustment range	550-900 mm
Roof inclination	5-53°
Standard	EN 62561-1
PU	1 pc(s)





Holder for metal roofs with round standing seam Screw with self-locking nut.

Part No.	123 040
Material of holder	StSt
Clamping range	Ø20-25 mm
Screw	⬆ M8 x 25 mm
Material of screw / nut	StSt
Standard	EN 62561-1
PU	12 pc(s)



Holder for metal roofs with clamping seam (e.g. RIB-ROOF Speed 500 from Zambelli) Screw with self-locking nut.

Part No.	123 041
Material of the holder	StSt
Clamping range	approx. 18 / 22 mm
Screw	⬆ M8 x 25 mm
Material of the screw / nut	StSt
Standard	EN 62561-1
PU	12 pc(s)



Holder for metal roofs with standing seam Screw with self-locking nut.

Part No.	123 042
Material of the holder	StSt
Clamping range	0.7-8 mm
Screw	⬆ M8 x 25 mm
Material of the screw / nut	StSt
Standard	EN 62561-1
PU	12 pc(s)



Holder for metal roofs for riveting or screwing Screw with self-locking nut.

Part No.	123 043
Material of the holder	StSt
Fixing	[4x] Ø5.2 / [2x] Ø6.5 mm
Screw	⬆ M8 x 25 mm
Material of the screw / nut	StSt
Standard	EN 62561-1
PU	12 pc(s)



C-mounting rail for mounting bracket for installation on metal roofs

C-mounting rails with holes for fixing the mounting bracket on roofs with large batten distances (> 600 mm).

Part No.	123 050 ^{NEW}	123 051 ^{NEW}	123 052 ^{NEW}
Material of the rail	StSt (V4A)	StSt (V4A)	StSt (V4A)
Dimensions of the rail (l x w x h)	[2x]1000 x 41 x 41 mm	[2x]1500 x 41 x 41 mm	[2x] 2000 x 41 x 41 mm
PU	1 pc(s)	1 pc(s)	1 pc(s)



Hanger bolt for wooden substructures

Hanger bolt for fixing the mounting bracket for installation on metal roofs on roofs with wooden substructures. To prevent the ingress of moisture, the hanger bolts feature a hexagon socket 5 mm and an EPDM seal membrane.

Part No.	528 820 ^{NEW}
Material	StSt
Thread length wood	70 mm
Metric thread length	M10 x 50 mm
Total length	185 mm
PU	1 pc(s)



Hanger bolt for metal substructures

Hanger bolt for fixing the mounting bracket for installation on metal roofs on roofs with metal substructures. To prevent the ingress of moisture, the hanger bolts feature a hexagon socket 5 mm and an EPDM seal membrane.

Part No.	528 821 ^{NEW}
Material	StSt
Thread length steel	65 mm
Metric thread length	M10 x 50 mm
Total length	180 mm
PU	1 pc(s)

5 Conductor Holder for Installation on Gable Roofs and Metal Roofs

Roof conductor holder

With pre-punched points for bending and hooking into the roof tile and screwing onto the battens, for installing the HVI light Conductor on gable roofs.

Part No.	202 829
Material of roof conductor holder	StSt
Material of conductor holder	StSt
Conductor support Rd	20 / 23 mm
Length of brace	205 mm
PU	1 pc(s)



Roof conductor holders for roofs with round standing seam

Roof conductor holder with slotted saddle clamp for fixing the HVI light Conductor, HVI Conductor onto metal roofs with round standing seam.

Part No.	202 850
Material of roof conductor holder	StSt
Material of conductor holder	StSt
Clamping range	Ø20-25 mm
Conductor support Rd	20 / 23 mm
Standard	EN 62561-4
PU	25 pc(s)



Roof conductor holder for roofs with clamping seam (e.g. RIB-ROOF Speed 500 from Zambelli)

Roof conductor holder with slotted saddle clamp for fixing the HVI light Conductor, HVI Conductor onto metal roofs with clamping seam.

Part No.	202 851
Material of roof conductor holder	StSt
Material of conductor holder	StSt
Clamping range	approx. 18 / 22 mm
Conductor support Rd	20 / 23 mm
Standard	EN 62561-4
PU	25 pc(s)



Roof conductor holder for roofs with standing seam

Roof conductor holder with slotted saddle clamp for fixing the HVI light Conductor, HVI Conductor onto metal roofs with standing seam.

Part No.	202 852
Material of roof conductor holder	StSt
Material of conductor holder	StSt
Clamping range	0.7-8 mm
Conductor support Rd	20 / 23 mm
Standard	EN 62561-4
PU	25 pc(s)



Roof conductor holder with connection lug

Roof conductor holder with slotted saddle clamp for HVI light Conductor, HVI Conductor and Z-shaped connection lug for riveting or screwing to metal roofs.

Part No.	202 853
Material of roof conductor holder	StSt
Material of conductor holder	StSt
Fixing	[4x] Ø5.2 / [2x] Ø6.5 mm
Conductor support Rd	20 / 23 mm
Standard	EN 62561-4
PU	25 pc(s)



5 Wall-Mounted Conductor Holders

Conductor holder

With thread.

Wall-mounted conductor holder with two-screw clamp (not for use in the sealing end range).



Part No.	275 250	275 251
Material of conductor holder	StSt	StSt
Conductor support Rd	20 / 23 mm	20 / 23 mm
Thread	M8	M6
Standard	EN 62561-4	EN 62561-4
PU	25 pc(s)	25 pc(s)

Conductor holder

With slotted hole.

Wall-mounted conductor holder with two-screw clamp (not for use in the sealing end range).



Part No.	275 252
Material of conductor holder	StSt
Conductor support Rd	20 / 23 mm
Fixing hole	5.5 x 10 mm
Standard	EN 62561-4
PU	25 pc(s)

Conductor holder

With plastic base.

Wall-mounted conductor holder with two-screw clamp (not for use in the sealing end range).



Part No.	275 259
Material of conductor holder	StSt
Conductor support Rd	20 / 23 mm
Thread	M8
Standard	EN 62561-4
PU	25 pc(s)

Conductor holder for HVI Conductor

For mounting on walls and in the sealing end range.



Part No.	275 220
Material of conductor holder	PA
Conductor support Rd	20 mm
Female thread	M8
Fixing hole	6.5 mm
PU	25 pc(s)

Stripping tool for HVI light Conductors / HVI Conductors

Tool for stripping the semi-conductive sheath and the PE insulation of the HVI light Conductor, HVI Conductor (outer diameter 20 mm).

- Tool consists of a handle and various exchangeable cutting heads
- Stripping length of HVI light Conductor, HVI Conductor is adjustable in steps of 0.2 mm (lock points) using the knob in the handle. The dial on the handle shows the length set.

Handling

Position the cutting head at the cut off end of the conductor and turn clockwise with light pressure to cut/strip it. The cutting head can be exchanged without tools via the bayonet coupling.

HVI strip 20

For HVI light and HVI Conductors (handle + cutting head).



Part No.	597 220
Diameter Ø conductor	20 mm
Material of moulded part	plastic
Material of blade	StSt
PU	1 pc(s)

HVI head 20

For HVI light and HVI Conductors (cutting head).

Part No.	597 120
Diameter Ø conductor	20 mm
Material of moulded part	plastic
Material of blade	StSt
PU	1 pc(s)

**Accessories for Stripping tool for HVI light Conductors / HVI Conductors****HVI head holder**

Adapter with bayonet coupling for attaching the HVI head cutting head (pre-set stripping length 35 mm). Adapter can be used in a standard three-jaw chuck (Ø10 mm), e.g. with cordless screwdrivers.

Part No.	597 139
Material	plastic / brass
PU	1 pc(s)

**Spare blades for HVI head 20**

1 set = 4 blades

Part No.	597 101
Material	StSt
PU	1 set

**Stripping Tool for HVI light Conductors / HVI Conductors**

Tool for stripping the additional grey sheath of the HVI light Conductor and HVI Conductor. DEHNhelix consists of a handle and an exchangeable bracket (depending on the conductor diameter).

DEHNhelix

Part No.	597 230
Diameter Ø conductor	23 mm
Material of moulded part	plastic
Material of blade	StSt
PU	1 pc(s)

**Accessory for Stripping Tool for HVI light Conductors / HVI Conductors****Spare blade for stripping tool**

Part No.	597 130
Material	StSt
PU	1 pc(s)

**Cable shears for HVI Conductors**

Cable shears for easily cutting the HVI light Conductor, HVI Conductor (outer diameter 20 / 23 mm), HVI power Conductor (outer diameter 27 mm) and CUI Conductor to length. The special design of the cable shears also allows precise cutting of stranded conductors, making it easier to attach connection elements.

**HVI cutter**

Part No.	597 032
Diameter Ø conductor	up to 32 mm
Material of blades	tool steel (CR-Moly (SCM440))
Material of handles	carbon steel (SS400)
Length	600 mm
PU	1 pc(s)



HVI Conductor

The HVI / HVI long Conductor can be used for a wide range of installations for example, to protect larger roof-mounted structures, antennas as well as masts with information technology systems against direct lightning strikes. Due to its special characteristics, this conductor can also be directly routed to the earth-termination system. If this is not required, connection to already existing conventional lightning protection systems (elevated / isolated ring conductor) is also possible.

If power needs to be distributed to several conductors to reduce the separation distance or if longer conductors are needed up to four additional conductors can be installed on the outside of the supporting tube using a special fixing kit.

With the high-voltage-resistant, insulated conductor a separation distance to electrically conductive parts according to IEC 62305-3 is maintained. Equivalent separation distance $s \leq 0.75$ m (air) or $s \leq 1.5$ m (solid material).

Two versions are available depending on the application:

- HVI Conductor (pre-assembled)
- HVI long Conductor (on a reel / cut to length)

HVI Conductor (pre-assembled)

The pre-assembled HVI Conductors, both for installation inside and outside the tube, have a tightly mounted head piece with a heat-shrinkable sleeve. The second conductor end can be precisely positioned with the connection element included as a loose part to suit the structure of the system.

HVI long Conductor (on a plywood reel / cut to length)

The HVI long Conductor can be assembled on site and thus allows for great flexibility when it comes to unknown or changing building situations and structures (new buildings, restoration) where the exact HVI Conductor lengths of the lightning protection system cannot be determined at the planning stage.

The HVI long Conductor is available with a length of 100 m on a disposable plywood reel (diameter approx. 900 mm, width approx. 485 mm) or as cut to length version (6 - 70 m).

The installer determines the exact length on site, cuts the conductor to length, strips it and attaches the sealing ends.



Technical data	HVI Conductor (pre-assembled)	HVI long Conductor (on a plywood reel)	HVI long Conductor (cut to length)
Structure	solid / stranded	solid / stranded	solid / stranded
Cross-section of inner conductor (Cu)	19 mm ²	19 mm ²	19 mm ²
Conductor colour	black / grey	black / grey	black / grey
Outer diameter	20 / 23 mm	20 / 23 mm	20 / 23 mm
Equivalent separation distance (air)	≤ 75 cm	≤ 75 cm	≤ 75 cm
Equivalent separation distance (solid material)	≤ 150 cm	≤ 150 cm	≤ 150 cm
Minimum bending radius (OD = outer diameter)	10 x OD, 200 / 230 mm	10 x OD, 200 / 230 mm	10 x OD, 200 / 230 mm
Operating temperature	-30 °C ... +70 °C	-30 °C ... +70 °C	-30 °C ... +70 °C
Temperature for installation	-5 °C ... +40 °C	-5 °C ... +40 °C	-5 °C ... +40 °C
Tensile strength	950 N	950 N	950 N
UV stability / weather resistance	yes	yes	yes
Tested with I _{imp} (10/350 μs) based on EN 62561-1	150 kA	150 kA	150 kA
For use in class of LPS in case of a single down conductor without current distribution (k _c = 1)	II, III, IV	II, III, IV	II, III, IV
Installation in Ex zone 1 and 21	allowed	allowed	allowed
Minimum order quantity	≥ 6 m	100 m	≥ 6 m
Max. order length	70 / 60 m	—	70 / 60 m
Cable weight / 100 m	—	48 / ~ 63 kg	—

Isolated protection of roof-mounted structures with HVI Conductor

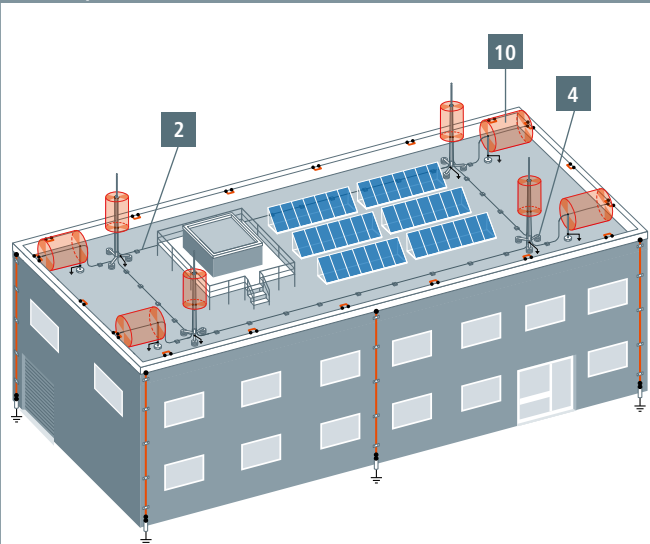

Installation of HVI Conductor

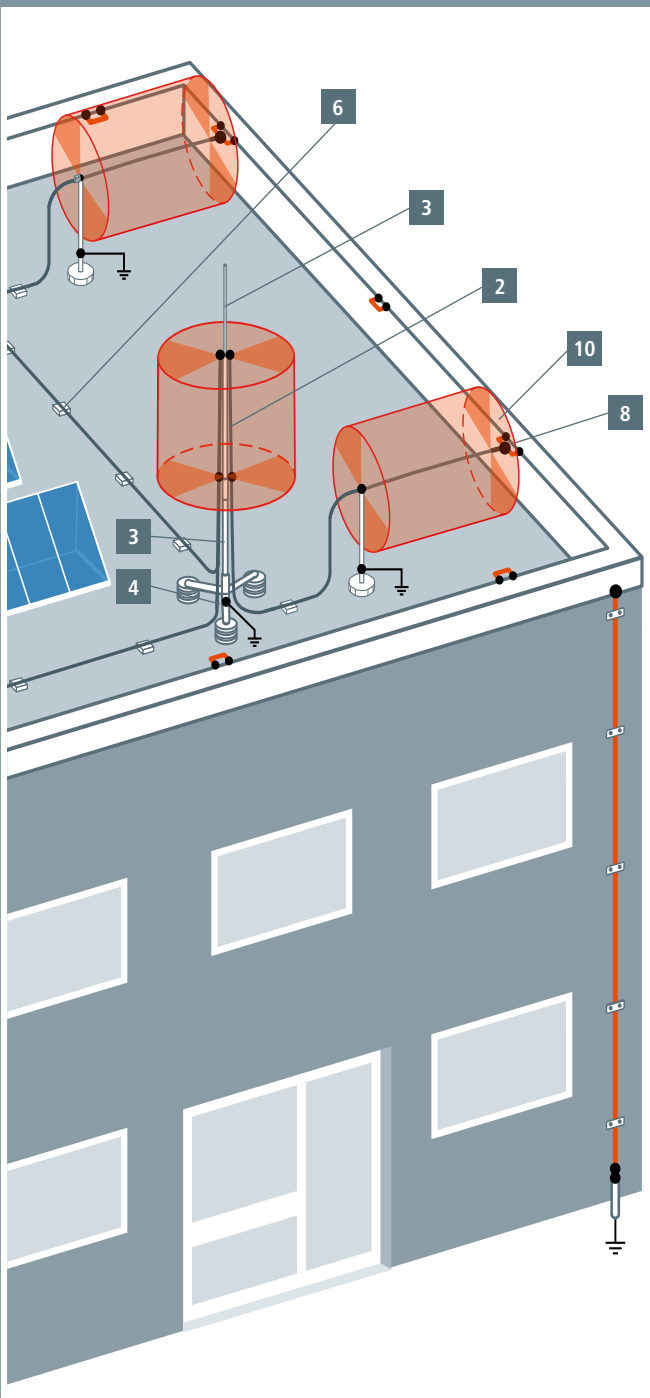

Product	Product name
	Supporting Tubes with HVI Conductor see page 170
	HVI Conductor HVI long Conductor Connection Elements see page 172
	Supporting Tubes for HVI long Conductors see page 175
	Tripods Accessories for Tripods see page 177
	Fixing Elements for Supporting Tubes see page 179
	Accessories for HVI Conductors / HVI long Conductors see page 181
	Conductor Holders for HVI Conductors / HVI long Conductors in Ex Areas see page 186
	Connecting Components 200 kA (10/350 μs) see page 188
	Stripping Tools Accessories see page 189
	Sealing End Ranges see page 191

Installation of the HVI Conductor on an antenna pole

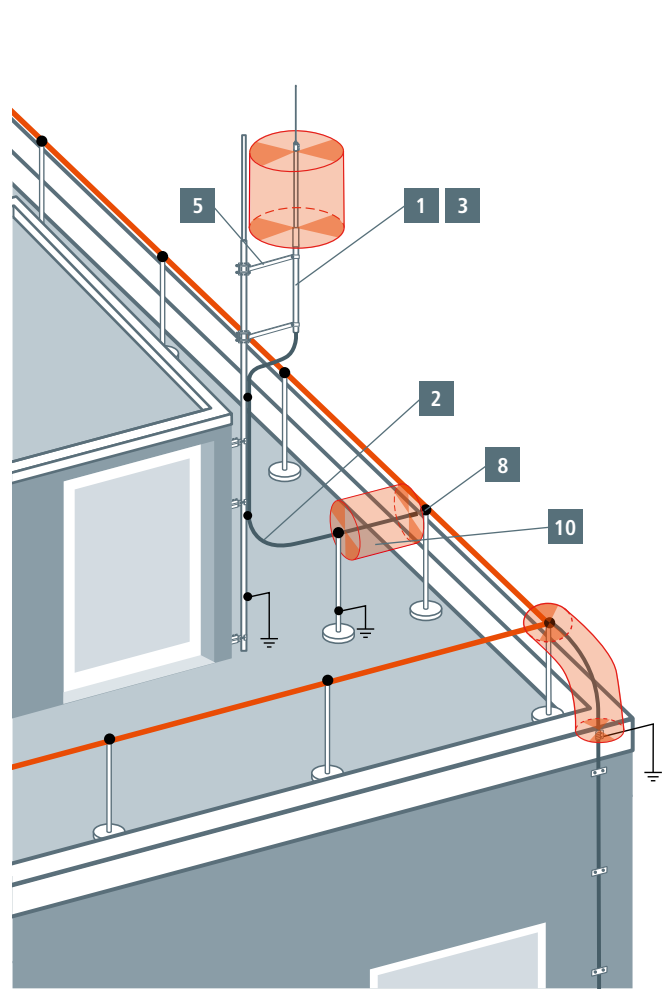
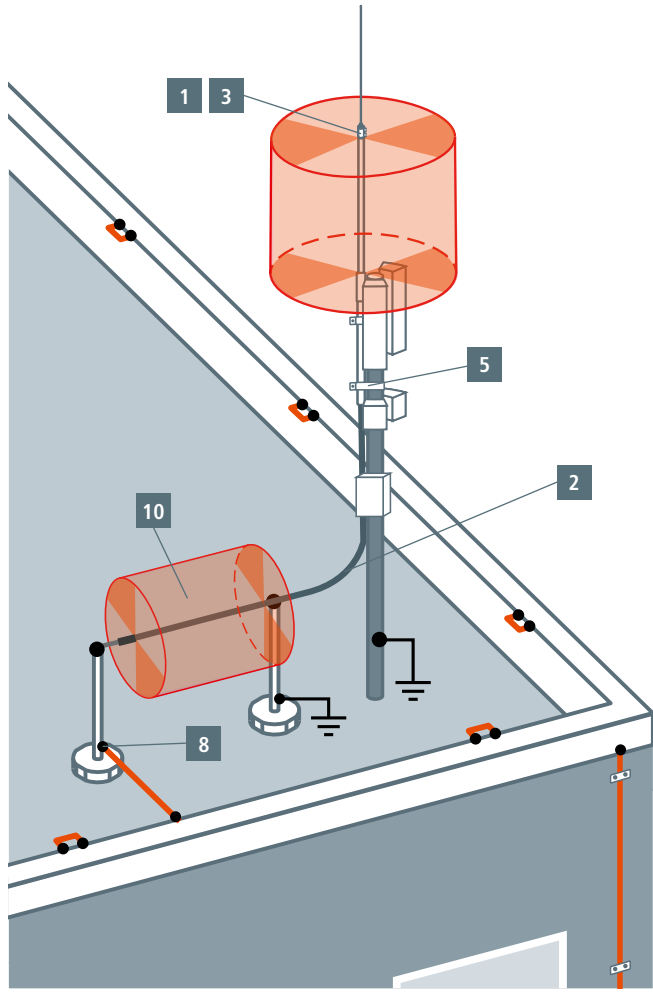

Installation of the HVI Conductor on a potentially explosive structure

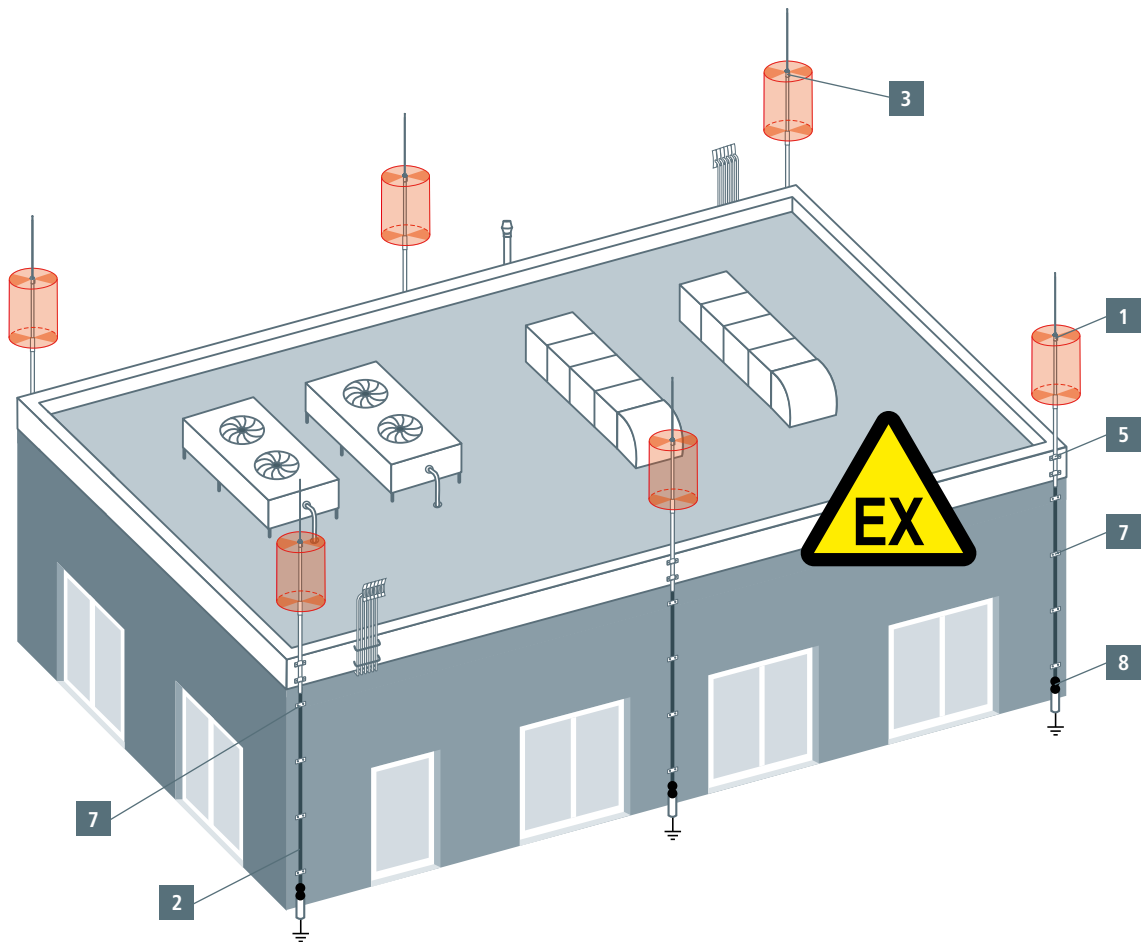

Installation of the HVI Conductor to protect a gas container

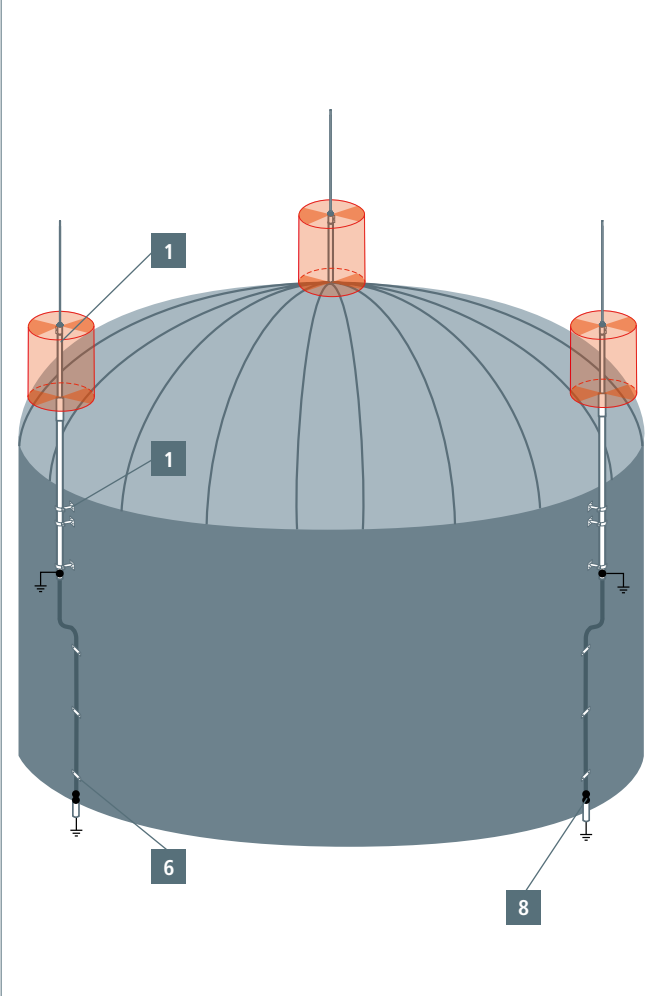

Installation of the HVI Conductor to protect a building with a thatched roof



Product	Product name
<p>1</p> 	<p>Supporting Tubes with HVI Conductor</p> <p>see page 170</p>
<p>2</p> 	<p>HVI Conductor HVI long Conductor Connection Elements</p> <p>see page 172</p>
<p>3</p> 	<p>Supporting Tubes for HVI long Conductors</p> <p>see page 175</p>
<p>4</p> 	<p>Tripods Accessories for Tripods</p> <p>see page 177</p>
<p>5</p> 	<p>Fixing Elements for Supporting Tubes</p> <p>see page 179</p>
<p>6</p> 	<p>Accessories for HVI Conductors / HVI long Conductors</p> <p>see page 181</p>
<p>7</p> 	<p>Conductor Holders for HVI Conductors / HVI long Conductors in Ex Areas</p> <p>see page 186</p>
<p>8</p> 	<p>Connecting Components 200 kA (10/350 μs)</p> <p>see page 188</p>
<p>9</p> 	<p>Stripping Tools Accessories</p> <p>see page 189</p>
<p>10</p> 	<p>Sealing End Ranges</p> <p>see page 191</p>

1 Supporting Tube with HVI Conductor



Optically optimised installation of the HVI Conductor inside the supporting tube creates less wind exposed area. For use up to an equivalent separation distance $s \leq 75$ cm (in air) or $s \leq 150$ cm (solid material). Conductor length to be indicated when ordering (steps of 0.5 m).

HVI Conductor in supporting tube with air-termination tip

With internal sealing end and air-termination tip, StSt, Ø10 mm, length 1000 mm.



Part No.	819 326	819 336
Material of supporting tube	GRP / Al	GRP / Al
Length of supporting tube	3200 mm	3200 mm
Transport length	3200 mm	3200 mm
Outside diameter Ø	50 mm	50 mm
Diameter Ø conductor	20 mm	23 mm
Colour of conductor	black ●	grey ●
Material of conductor	Cu	Cu
Minimum order length	6 m	6 m
Max. free length with air-termination tip (wall mounting)	3500 mm	3500 mm
Max. gust wind speed (wall mounting, 1x HVI inside)	237 km/h	237 km/h
Max. gust wind speed (wall mounting, 1x HVI outside)	227 km/h	225 km/h
Max. gust wind speed (wall mounting, 4x HVI outside)	197 km/h	197 km/h
PU	1 pc(s)	1 pc(s)

Max. gust wind speed (tripod with supporting tube) see table on page 140.

HVI Conductor in supporting tube with air-termination rod

With internal sealing end and air-termination rod, Al, Ø22 / 16 / 10 mm, length 2500 mm.



Part No.	819 328	819 338	819 426	819 438
Material of supporting tube	GRP / Al	GRP / Al	GRP / Al	GRP / Al
Length of supporting tube	3200 mm	3200 mm	4700 mm	4700 mm
Transport length	3200 mm	3200 mm	4700 mm	4700 mm
Outside diameter Ø	50 mm	50 mm	50 mm	50 mm
Diameter Ø conductor	20 mm	23 mm	20 mm	23 mm
Colour of conductor	black ●	grey ●	black ●	grey ●
Material of conductor	Cu	Cu	Cu	Cu
Minimum order length	6 m	6 m	6 m	6 m
Max. free length with air-termination rod (wall mounting)	5000 mm	5000 mm	5000 mm	5000 mm
Max. gust wind speed (wall mounting, 1x HVI inside)	190 km/h	190 km/h	190 km/h	190 km/h
Max. gust wind speed (wall mounting, 1x HVI outside)	175 km/h	175 km/h	175 km/h	175 km/h
Max. gust wind speed (wall mounting, 4x HVI outside)	163 km/h	163 km/h	163 km/h	163 km/h
PU	1 pc(s)	1 pc(s)	1 pc(s)	1 pc(s)

Max. gust wind speed (tripod with supporting tube) see table on page 140.

HVI Conductor in supporting tube (side outlet) with air-termination tip and small tripod

With internal sealing end and air-termination tip, StSt, Ø10 mm, length 1000 mm.

With tripod (Part No. 105 390) and set of threaded rods (Part No. 105 397).



Part No.	819 371	819 381
Material of supporting tube	GRP / Al	GRP / Al
Length of supporting tube	3200 mm	3200 mm
Transport length	3200 mm	3200 mm
Outside diameter Ø	50 mm	50 mm
Diameter Ø conductor	20 mm	23 mm
Colour of conductor	black ●	grey ●
Material of conductor	Cu	Cu
Radius of tripod	600 mm	600 mm
Space required for tripod	1400 x 1200 mm	1400 x 1200 mm
Length of threaded rods	M16 x 520 mm	M16 x 520 mm
Minimum order length	6 m	6 m
PU	1 pc(s)	1 pc(s)

Max. gust wind speed (tripod with supporting tube) see table on page 140.

HVI Conductor

HVI Conductor in supporting tube (side outlet) with air-termination rod and small tripod

With internal sealing end and air-termination rod, Al, Ø22 /16 / 10 mm, length 2500 mm.
With tripod (Part No. 105 390) and set of threaded rods (Part No. 105 397).

Part No.	819 373	819 383
Material of supporting tube	GRP / Al	GRP / Al
Length of supporting tube	3200 mm	3200 mm
Transport length	3200 mm	3200 mm
Outside diameter Ø	50 mm	50 mm
Diameter Ø conductor	20 mm	23 mm
Colour of conductor	black ●	grey ●
Material of conductor	Cu	Cu
Radius of tripod	600 mm	600 mm
Space required for tripod	1400 x 1200 mm	1400 x 1200 mm
Length of threaded rods	M16 x 520 mm	M16 x 520 mm
Minimum order length	6 m	6 m
PU	1 pc(s)	1 pc(s)



HVI Conductor in supporting tube (side outlet) with air-termination rod and large tripod

With internal sealing end and air-termination rod, Al, Ø22 /16 / 10 mm, length 2500 mm.
With tripod (Part No. 105 391) and set of threaded rods (Part No. 105 398).

Part No.	819 473	819 483
Material of supporting tube	GRP / Al	GRP / Al
Length of supporting tube	4700 mm	4700 mm
Transport length	4700 mm	4700 mm
Outside diameter Ø	50 mm	50 mm
Diameter Ø conductor	20 mm	23 mm
Colour of conductor	black ●	grey ●
Material of conductor	Cu	Cu
Radius of tripod	1450 mm	1450 mm
Space required for tripod	2900 x 2600 mm	2900 x 2600 mm
Length of threaded rods	M16 x 650 mm	M16 x 650 mm
Minimum order length	6 m	6 m
PU	1 pc(s)	1 pc(s)



Max. gust wind speed (tripod with supporting tube) see table on page 140.

The conductor cannot be returned as it is made to order.

1 Air-Termination Mast with HVI Conductor

For a maximum free length of the whole air-termination system of 8.5 m.
To be fixed with three variable supports (Part No. 105 345). Transport length 6000 mm.

With 1x HVI Conductor installed inside the supporting tube. Conductor length has to be stated when ordering (0.5 m steps).
Maximum total length of the HVI Conductor of 12.5 m in case of class of LPS II.
Maximum total length of the HVI Conductor of 18.5 m in case of class of LPS III.

Part No.	819 730
Total length of air-termination mast	10800 mm
Length of air-termination rod	3000 mm
Length of supporting tube	2100 mm
Length of mast pipe	6000 mm
Colour of conductor	black ●
Minimum order length	10.0 m
Max. gust wind speed	166 km/h
PU	1 pc(s)



Accessory for Air-Termination Mast with HVI Conductor

Variable support for air-termination masts

Three supports should be mounted for each air-termination mast.
Clamping range of air-termination mast Ø60 mm.

Part No.	105 345
Material of support	St/tZn
Adjustment range	250-350 mm
Fixing holes Ø	[4x] 12 x 25 mm
PU	1 pc(s)



2 HVI Conductor / HVI long Conductor



High-voltage-resistant, insulated down conductor for keeping the separation distance to electrically conductive parts according to IEC/EN 62305-3.
For use up to an equivalent separation distance $s \leq 75$ cm (in air) or $s \leq 150$ cm (solid material).



HVI Conductor (pre-assembled, installation inside the supporting tube)

With one head piece and one connection element (enclosed loose).
Minimum order length 6 m, conductor length has to be stated when ordering (in steps of 0.5 m).

Part No.	819 220	819 223
Material of conductor	Cu	Cu
Material of insulation	PE	PE
Material of sheath	PVC / PE	PVC
Colour of conductor	black ●	grey ●
Diameter Ø conductor	20 mm	23 mm
Minimum order length	6 m	6 m
PU	1 pc(s)	1 pc(s)



HVI Conductor (pre-assembled, installation outside the supporting tube)

With one head piece and one connection element (enclosed loose).
Minimum order length 6 m, conductor length has to be stated when ordering (in steps of 0.5 m).

Part No.	819 226	819 227
Material of conductor	Cu	Cu
Material of insulation	PE	PE
Material of sheath	PVC / PE	PVC
Colour of conductor	black ●	grey ●
Diameter Ø conductor	20 mm	23 mm
Minimum order length	6 m	6 m
PU	1 pc(s)	1 pc(s)

HVI long Conductor (on a cable reel)

The HVI long Conductor comes in a length of 100 m on a disposable plywood reel (diameter approx. 800 mm, width approx. 485 mm). Allen key included in delivery.



Part No.	819 135	819 136
Material of conductor	Cu	Cu
Material of insulation	PE	PE
Material of sheath	PVC / PE	PVC
Colour of conductor	black ●	grey ●
Diameter Ø conductor	20 mm	23 mm
PU	100 m	100 m

HVI long Conductor (cut to length)

Cut-to-length HVI long Conductor for on-site assembly. Conductor is delivered as a coil.
Conductor length has to be stated when ordering (0.5 m steps).



Part No.	819 131	819 132
Material of conductor	Cu	Cu
Material of insulation	PE	PE
Material of sheath	PVC	PVC
Colour of conductor	black ●	grey ●
Diameter Ø conductor	20 mm	23 mm
Minimum order length	6 m	6 m
Max. order length	70 m	60 m
PU	1 pc(s)	1 pc(s)

2 Connection Elements for HVI long Conductor



Connection kit for HVI long Conductor Ø20 mm, installation inside the supporting tube

Connection elements for sealing the HVI long Conductor at both ends, for implementing the sealing end of the conductor in the supporting tube (head piece) and connection element for connection to other parts of the external lightning protection system or earth-termination system (incl. two heat-shrinkable sleeves).

These connection elements may be used with HVI long supporting tubes.

Part No.	819 145
Material	StSt
Connection	bolt Ø10 mm, L 50 mm
Diameter Ø connection element	23 mm
PU	1 pc(s)



Connection kit for HVI long Conductor Ø20, mm installation outside the supporting tube

Connection elements for sealing the HVI long Conductor at both ends, for implementing the sealing end of the conductor outside the supporting tube (head piece for connection plate) and connection element for connection to other parts of the external lightning protection system or earth-termination system (incl. two heat-shrinkable sleeves and four cable ties).

These connection elements may only be used for HVI long supporting tubes in combination with the fixing kit (Part No. 819 294).

Part No.	819 146
Material	StSt
Connection	bolt Ø10 mm, L 50 mm
Diameter Ø connection element	23 mm
PU	1 pc(s)

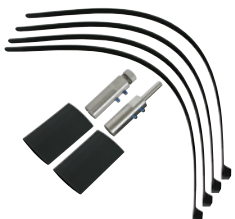

Connection element (head piece) for HVI long Conductor Ø20, mm installation outside the supporting tube

Connection element for sealing the HVI long Conductor, for implementing the sealing end of the conductor on the outside of the supporting tube (head piece for connection plate). Incl. one heat-shrinkable sleeve and two cable ties.

Part No.	819 197
Material	StSt
Connection	M12 thread
Diameter Ø connection element	23 mm
PU	1 pc(s)



Connection element for HVI long Conductor Ø20 mm

Connection element for sealing the HVI long Conductor, for implementing the sealing end of the conductor for other parts of the external lightning protection or earth-termination system. Incl. one heat-shrinkable sleeve and two cable ties.

Part No.	819 199
Material	StSt
Connection	bolt Ø10 mm, L 50 mm
Diameter Ø connection element	23 mm
PU	1 pc(s)



Connection kit for HVI long Conductor Ø23, mm installation inside the supporting tube

Connection elements for sealing the HVI long Conductor at both ends, for implementing the sealing end of the conductor inside the supporting tube (head piece) and connection element for connection to other parts of the external lightning protection or earth-termination system (incl. four heat-shrinkable sleeves).

These connection elements may be used with HVI long supporting tubes.

Part No.	819 147
Material	StSt
Connection	bolt Ø10 mm, L 50 mm
Diameter Ø connection element	23 mm
PU	1 pc(s)



Connection kit for HVI long Conductor Ø23, mm installation outside the supporting tube

Connection elements for sealing the HVI long Conductor at both ends, for implementing the sealing end of the conductor outside the supporting tube (head piece for connection plate) and connection element for connection to other parts of the external lightning protection or earth-termination system (incl. four heat-shrinkable sleeves and four cable ties).

These connection elements may only be used with the fixing kit (Part No. 819 294) and with HVI supporting tubes.

Part No.	819 148
Material	StSt
Connection	bolt Ø10 mm, L 50 mm
Diameter Ø connection element	23 mm
PU	1 pc(s)

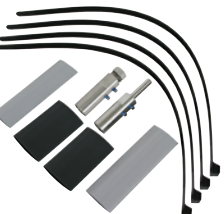

HVI Conductor

Connection element (head piece) for HVI long Conductor Ø23, mm installation outside the supporting tube

Connection element for sealing the HVI long Conductor, for establishing the sealing end of the conductor outside the supporting tube (head piece for connection plate). Incl. two heat-shrinkable sleeves and two cable ties.



Part No.	819 196
Material	StSt
Connection	M12 thread
Diameter Ø connection element	23 mm
PU	1 pc(s)

Connection element for HVI long Conductor Ø23 mm

Connection element for sealing the HVI long Conductor, for establishing the sealing end of the conductor for other parts of the external lightning protection or earth-termination system. Incl. two heat-shrinkable sleeves and two cable ties.

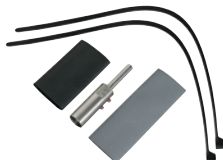

Part No.	819 198
Material	StSt
Connection	bolt Ø10 mm, L 50 mm
Diameter Ø connection element	23 mm
PU	1 pc(s)

Fixing kit for HVI long Conductor black / grey

Fixing kit for installation of the HVI long Conductor on HVI long supporting tubes, consisting of connection plate (for four conductors, incl. two serrated lock nuts) and fixing ring with four slotted conductor holders (D 20 mm) for the sealing end (incl. two cable ties).



Part No.	819 294
Material	StSt / Al
Connection plate support	square hole 13 mm
Conductor holder	4 x 20 mm
PU	1 pc(s)

EB connection element for HVI long Conductor

For discharging the electric field of the HVI long Conductor in the sealing end range. Special slotted design to electrically contact the semi-conductive sheath.



Part No.	410 229
Material	StSt
Clamping range Ø	20 mm
Connection hole Ø	11 mm
PU	1 pc(s)

Connection plate

Connection plate (for four conductors, incl. two serrated lock nuts) for installing the HVI long Conductor on the supporting tube D 50 mm (e.g. Part No. 105 330, 105 331, 105 332, 105 333).



Part No.	819 288
Material	StSt
Connection plate support	square hole 13
PU	1 pc(s)

Accessories for Connection Elements for HVI long Conductor
Fixing bolt

Fixing bolt for spanning a 50 mm² aluminium cable Part No. 840 050 to an air-termination rod (Ø22 / Ø16 mm) or a connection plate (e.g. Part No. 819 289 or 819 288).



Part No.	105 229
Hole	1x B 11 mm, 1x B 23 mm
Material of bolt	Al
Wire end ferrule	50 mm ²
Material of wire end ferrule	Cu/Sn
Standard	EN 62561-1
PU	10 pc(s)

Wire end ferrule

Wire end ferrule for securely fixing the aluminium cable with a cross-section of 50 mm² (Part No. 840 050). 1 set = 10 pieces



Part No.	444 050
Material	Cu/Sn
Cross section	50 mm ²
PU	1 set

3 Supporting Tubes for HVI long Conductor



With air-termination tip

Supporting tube with internal sealing end and EB spring element.
Air-termination tip, StSt, Ø10 mm, length 1000 mm.

Part No.	105 330	105 332	105 314	105 316
Material of supporting tube	GRP / Al	GRP / Al	GRP / StSt	GRP / StSt
Length of supporting tube	3200 mm	4700 mm	3200 mm	4700 mm
Transport length	3200 mm	4700 mm	3200 mm	4700 mm
Outside diameter Ø	50 mm	50 mm	50 mm	50 mm
Length of insulating clearance	1535 mm	1535 mm	1535 mm	1535 mm
Max. free length with air-termination tip (wall mounting)	3500 mm	3500 mm	3500 mm	3500 mm
Max. gust wind speed (wall mounting, 1x HVI inside)	237 km/h	237 km/h	234 km/h	234 km/h
Max. gust wind speed (wall mounting, 1x HVI outside)	225 km/h	225 km/h	229 km/h	229 km/h
Max. gust wind speed (wall mounting, 4x HVI outside)	197 km/h	197 km/h	200 km/h	200 km/h
PU	1 pc(s)	1 pc(s)	1 pc(s)	1 pc(s)



With air-termination rod

Supporting tube with internal sealing end and EB spring element.
Air-termination rod, Ø22/16/10 mm, length 2500 mm.

Part No.	105 331	105 333	105 315	105 317
Material of air-termination rod	Al	Al	StSt	StSt
Material of supporting tube	GRP / Al	GRP / Al	GRP / StSt	GRP / StSt
Length of supporting tube	3200 mm	4700 mm	3200 mm	4700 mm
Transport length	3200 mm	4700 mm	3200 mm	4700 mm
Outside diameter Ø	50 mm	50 mm	50 mm	50 mm
Length of insulating clearance	1535 mm	1535 mm	1535 mm	1535 mm
Max. free length with air-termination rod (wall mounting)	5000 mm	5000 mm	5000 mm	5000 mm
Max. gust wind speed (wall mounting, 1x HVI inside)	190 km/h	190 km/h	188 km/h	188 km/h
Max. gust wind speed (wall mounting, 1x HVI outside)	175 km/h	175 km/h	173 km/h	173 km/h
Max. gust wind speed (wall mounting, 4x HVI outside)	163 km/h	163 km/h	159 km/h	159 km/h
PU	1 pc(s)	1 pc(s)	1 pc(s)	1 pc(s)



With air-termination tip and side outlet

Supporting tube with internal sealing end and EB spring element.
Air-termination tip, StSt, Ø10 mm, length 1000 mm.

Part No.	105 325	105 327	105 336	105 338
Material of supporting tube	GRP / Al	GRP / Al	GRP / StSt	GRP / StSt
Length of supporting tube	3200 mm	4700 mm	3200 mm	4700 mm
Transport length	3200 mm	4700 mm	3200 mm	4700 mm
Outside diameter Ø	50 mm	50 mm	50 mm	50 mm
Length of insulating clearance	1535 mm	1535 mm	1535 mm	1535 mm
PU	1 pc(s)	1 pc(s)	1 pc(s)	1 pc(s)





With air-termination rod and side outlet

Supporting tube with internal sealing end and EB spring element.
Air-termination rod Ø22/16/10 mm, length 2500 mm.

Part No.	105 326	105 328	105 337	105 339
Material of air-termination rod	Al	Al	StSt	StSt
Material of supporting tube	GRP / Al	GRP / Al	GRP / StSt	GRP / StSt
Length of supporting tube	3200 mm	4700 mm	3200 mm	4700 mm
Transport length	3200 mm	4700 mm	3200 mm	4700 mm
Outside diameter Ø	50 mm	50 mm	50 mm	50 mm
Length of insulating clearance	1535 mm	1535 mm	1535 mm	1535 mm
PU	1 pc(s)	1 pc(s)	1 pc(s)	1 pc(s)

Max. gust wind speed (tripod with supporting tube) see table on page 140.

Accessories for Supporting Tubes for HVI long Conductor

Sideways air-termination tips Al for supporting tubes

Fixing kit for mounting sideways/horizontal air-termination tips on HVI long supporting tubes and HVI power supporting tubes. Consisting of four air-termination tips and one fixing ring.

Note: The additional wind load on the air-termination system with the horizontally mounted air-termination tips must be observed!

Part No.	819 183	819 185
Length of air-termination tip	530 mm	1030 mm
Material of air-termination tip	Al	Al
Material of fixing ring	Al	Al
PU	1 pc(s)	1 pc(s)

Sideways air-termination tips StSt for supporting tubes

Fixing kit for mounting sideways/horizontal air-termination tips on HVI long supporting tubes and HVI power supporting tubes. Consisting of four air-termination tips and one fixing ring.

Note: The additional wind load on the air-termination system with the horizontally mounted air-termination tips must be observed!

Part No.	819 184	819 186
Length of air-termination tip	530 mm	1030 mm
Material of air-termination tip	StSt	StSt
Material of fixing ring	StSt	StSt
PU	1 pc(s)	1 pc(s)



4 Tripod for Supporting Tubes without Side Outlet



Special design for HVI Conductor installed inside / outside the supporting tube, with double clamp for connection of 2x Rd 8-10 mm. To keep within the bending radius of the HVI Conductor (installed inside the supporting tube) at the bottom of the tripod, two concrete bases must be positioned under and one on top of the brace. Adjustable to the roof inclination up to max. 10°.

The stackable concrete base (Part No. 102 010) and the base plate (Part No. 102 050) have to be ordered separately.

Tripod small

Suitable for HVI Conductors installed inside the supporting tube.

Part No.	105 351
Material of tripod	St/tZn
Support	50 mm
Radius	620 mm
Number of concrete bases	3-12 blocks, 17 kg each
Space required for tripod	1300 x 1450 mm
PU	1 pc(s)



Tripod large

Suitable for HVI Conductors installed outside the supporting tube.

Part No.	105 201
Material of tripod	St/tZn
Support	40 / 50 mm
Radius	1435 mm
Number of concrete bases	3-12 blocks 17 kg each
Space required for tripod	2520 x 2860 mm
PU	1 pc(s)



Accessories for Tripod for Supporting Tubes without Side Outlet

Bracing

Bracing, 3-fold with clamp for tubes D 50 mm for fixing to the tripod (Part No. 105 201). Bracing suitable for supporting tubes with a length of 4700 mm (e.g. Part Nos. 105 332, 105 316, 105 333, 105 317, 105 322, 105 323, 105 565, 105 575).

Part No.	105 601
Material	StSt
Brace length	2910 mm
Ø clamp	50 mm
PU	1 pc(s)

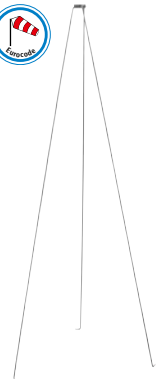

Concrete base

With fixing wedge, stackable, for erecting tripods and air-termination rods Ø16 mm, chamfered or tapered, DEHNiso spacer Ø16 mm or conductor holder (Part No. 253 279).

Part No.	102 010
Weight	17 kg
Support	with fixing wedge Ø16 mm
Diameter Ø	337 mm
Material	concrete (C45/55)
Material of wedge / adapter	StSt
PU	54 pc(s)



Base plate

To protect the roof sheeting under the concrete base. For concrete bases (Part Nos. 102 010, 102 002).

Part No.	102 050
Outside diameter Ø	370 mm
Inside diameter Ø	360 mm
Material	EVA
Colour	black ●
PU	1 pc(s)



4 Tripods for Supporting Tubes with Side Outlet



Special design for supporting tube with HVI Conductor installed inside the supporting tube, with side outlet and double clamp for connection of 2x Rd 8-10 mm. Adjustable to the roof inclination up to max. 5°

The stackable concrete base (Part No. 102 012) and the base plate (Part No. 102 050) as well as the threaded rod sets (Part Nos. 105 396-105 398 or Part Nos. 105 496-105 498) must to be ordered separately.

Tripod, small



Part No.	105 390
Material	StSt
Support	50 mm
Radius	600 mm
Space required for stand	1400 x 1200 mm
PU	1 pc(s)

Tripod, large

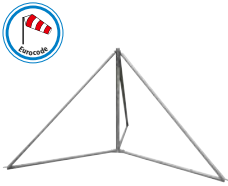

Part No.	105 391
Material	StSt
Support	50 mm
Radius	1450 mm
Space required for stand	2900 x 2500 mm
PU	1 pc(s)

Four-legged stand, small



Part No.	105 490
Material	StSt
Support	50 mm
Radius	600 mm
Space required for stand	1200 x 1200 mm
PU	1 pc(s)

Four-legged stand, large

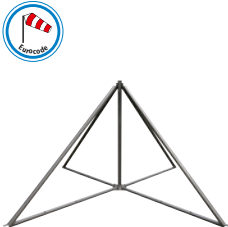

Part No.	105 491
Material	StSt
Support	50 mm
Radius	1450 mm
Space required for stand	2400 x 2400 mm
PU	1 pc(s)

Accessories for Tripods for Supporting Tubes with Side Outlet

Set of threaded rods for tripod

Consisting of three threaded rods, each with 2 nuts and a spring washer.



Part No.	105 396	105 397	105 398
For tripod	Part No. 105 390 / 105 391	Part No. 105 390 / 105 391	Part No. 105 390 / 105 391
Number of concrete blocks	1 to 2	1 to 3	3 to 4
Material	StSt	StSt	StSt
Length	M16 x 340 mm	M16 x 520 mm	M16 x 650 mm
PU	1 pc(s)	1 pc(s)	1 pc(s)

Set of threaded rods for four-legged stand

Consisting of four threaded rods, each with a base plate, each with 2 nuts and a spring washer.



Part No.	105 496	105 497	105 498
For four-legged stand	Part No. 105 490 / 105 491	Part No. 105 490 / 105 491	Part No. 105 490 / 105 491
Quantity of concrete blocks	1 to 2	1 to 3	3 to 4
Material	StSt	StSt	StSt
Length	M16 x 340 mm	M16 x 520 mm	M16 x 650 mm
PU	1 pc(s)	1 pc(s)	1 pc(s)

Concrete base

Concrete base without wedge, for erecting tripods.

Part No.	102 012
Weight	17 kg
Support	Ø16 mm
Diameter Ø	337 mm
Material	concrete (C45/55)
PU	54 pc(s)



Base plate

To protect the roof sheeting under the concrete base.
For concrete bases (Part Nos. 102 010, 102 002).

Part No.	102 050
Outside diameter Ø	370 mm
Inside diameter Ø	360 mm
Material	EVA
Colour	black ●
PU	1 pc(s)



5 Fixing Elements for Supporting Tubes

Fixing clamp with tensioning strap

For fixing supporting tubes to structural elements, e.g. antenna masts.

Part No.	105 360
Material of clip	StSt
Clamping range for supporting tube	50 mm
Clamping range for pipe Ø	50-300 mm
Material of tensioning strap	StSt
Dimensions of strap (w x d)	25 x 0.3 mm
PU	1 pc(s)



Fixing clamp with tensioning strap

With additional spacer for adjusting the sector antenna holders to the mast.

Part No.	105 361
Material of clip	StSt
Clamping range for supporting tube	50 mm
Clamping range for pipe Ø	50-300 mm
Material of tensioning strap	StSt
Dimensions of strap (w x d)	25 x 0.3 mm
Length of spacer	30 mm
PU	1 pc(s)



Fixing clamp with tensioning strap

With additional long spacer for adjusting sector antenna holders to the mast.

Part No.	105 362
Material of clip	StSt
Clamping range for supporting tube	50 mm
Clamping range for pipe Ø	50-300 mm
Material of tensioning strap	StSt
Dimensions of strap (w x d)	25 x 0.3 mm
Length of spacer	95 mm
PU	1 pc(s)



Wall mounting bracket for horizontal mounting, flat

For fixing supporting tubes onto the structure to be protected or the wall.



Part No.	105 340
Material	StSt
Clamping range for supporting tube	50 mm
Distance from wall / corner	80 mm
Dimensions of fixing	320 mm
Fixing	[8x] Ø5.1 / [4x] 11 x 20 mm
PU	1 pc(s)

Wall mounting bracket for horizontal mounting, corner

For fixing supporting tubes onto the structure to be protected or the wall.



Part No.	105 341
Material	StSt
Clamping range for supporting tube	50 mm
Distance from wall / corner	80 mm
Dimensions of fixing	152 mm
Fixing	[8x] Ø5.1 / [4x] 11 x 20 mm
PU	1 pc(s)

Wall mounting bracket for vertical mounting

For fixing supporting tubes or air-termination rods D40 / D50 to roof-mounted structures or walls.



Part No.	105 342	105 348
Material of bracket	StSt	StSt
Fixing	[8x] Ø5.1 / [4x] 7 x 10 / [2x] 11 x 20 mm	[8x] Ø5.1 / [4x] 7 x 10 / [2x] 11 x 20 mm
Clamping range for supporting tube	40-50 mm	40-50 mm
Distance from wall	46 mm	110 mm
PU	1 pc(s)	1 pc(s)

Wall mounting bracket, adjustable from 150-200 mm

For fixing supporting tubes or air-termination rods D40 / D50 with double clamp, for the connecting 2x Rd 8-10 mm.



Part No.	105 344
Material of bracket	StSt
Clamping range for supporting tube	40-50 mm
Distance from wall	150-200 mm
Dimensions of plate	120 x 120 x 4 mm
Fixing	[4x] 12 x 26 mm
Standard	EN 62561-1
PU	1 pc(s)

Wall mounting bracket, adjustable from 230-1300 mm

For fixing supporting tubes or air-termination rods D40 / D50.



Part No.	105 347	105 343	105 349
Material of bracket	St/tZn / StSt	St/tZn / StSt	St/tZn / StSt
Clamping range for supporting tube	40-50 mm	40-50 mm	40-50 mm
Distance from wall	230-400 mm	400-700 mm	700-1300 mm
Dimensions of plate	120 x 120 x 4 mm	120 x 120 x 4 mm	120 x 120 x 4 mm
Fixing	[4x] 12 x 26 mm	[4x] 12 x 26 mm	[4x] 12 x 26 mm
PU	1 pc(s)	1 pc(s)	1 pc(s)

Railing clamp

For pipes.



Part No.	105 354
Material	StSt
Clamping range for pipe Ø	48-60 mm (1½-2")
Clamping range for supporting tube	40-50 mm
PU	5 pc(s)

HVI Conductor

Railing clamp

For pipes.

Part No.	105 355
Material	StSt
Clamping range for pipe Ø	70-90 mm (2 1/4-3")
Clamping range for supporting tube	40-50 mm
PU	1 pc(s)



Railing clamp

For square hollow profiles.

Part No.	105 356	105 376
Material	StSt	StSt
Clamping range for square profile	20 x 20 to 50 x 50 mm	60 x 120 mm
Clamping range for supporting tube	40-50 mm	40-50 mm
PU	5 pc(s)	1 pc(s)



5 Spacers for Omnidirectional Antennas

Spacer for DEHNiso Combi supporting tubes with HVI Conductor installed inside and/or outside the supporting tube, mounted on the antenna mast.

Part No.	105 363	105 364	105 365
Material of support / square profile	St/tZn	St/tZn	St/tZn
Clamping range (Ø mast)	55-100 mm	100-150 mm	150-190 mm
Clamping range of supporting tube	50 mm	50 mm	50 mm
Length of spacer	1000 mm	1000 mm	1000 mm
Dimensions (w x h x d)	140 x 120 x 55 mm	190 x 140 x 60 mm	230 x 180 x 70 mm
PU	1 pc(s)	1 pc(s)	1 pc(s)



Spacers for omnidirectional antennas with special lengths or any other diameters are available upon request!

6 Accessories for HVI Conductor and HVI long Conductor

Note: Contact us to find out whether the material of the roof conductor holders or base plates are compatible with the roof elements.

Roof conductor holder for flat roofs

For fixing round conductors and strips on flat roofs with one conductor support type FB.

Part No.	253 015
Conductor routing	loose
Material of conductor holder	plastic
Conductor support Rd	8 mm
Block	concrete (C35/45)
Weight	1 kg
PU	10 pc(s)



Adapter for installing the HVI light Conductor / HVI Conductor on flat roofs

To be snapped on roof conductor holder type FB (Part No. 253 015).

Part No.	253 026
Material	plastic
Colour	black ●
Conductor support Rd	20 mm
PU	50 pc(s)



Adapter for installing the HVI Conductor on flat roofs

To be snapped onto roof conductor holder type FB (Part No. 253 015).

Part No.	253 027
Material	plastic
Colour	black ●
Conductor support Rd	23 mm
PU	50 pc(s)



Roof conductor holder

For flat roofs, weight approx. 4.7 kg. Conductor holder, concrete block and base plate, for installing the HVI light Conductor, HVI Conductor on flat roofs.

Part No.	253 229
Material of conductor holder	StSt
Conductor support Rd	20 / 23 mm
Total weight	approx. 4.7 kg
PU	1 pc(s)



Roof conductor holder

For flat roofs, weight approx. 8.6 kg.
Conductor holder, concrete block and base plate, for installing the HVI light Conductor, HVI Conductor on flat roofs.

Part No.	253 239
Material of conductor holder	StSt
Conductor support Rd	20 / 23 mm
Total weight	approx. 8.6 kg
PU	1 pc(s)

Conductor holder

Conductor holder with slotted clamp for HVI light Conductor, HVI Conductor for fixing in the base plate (Part No. 253 300) with concrete block (Part No. 253 301).



Part No.	253 289
Material	StSt
Conductor support Rd	20 / 23 mm
Height of conductor holder	87 mm
Bolt	Ø10 mm (push-fit)
PU	1 pc(s)

Concrete block

For stabilising the base plate.



Part No.	253 301
Material	concrete (C35/45)
Weight	4.6 kg
Dimensions	180 x 180 x 70 mm
PU	24 pc(s)

Base plate

Base plate to hold the spacer bar (Part Nos. 253 315, 253 325) and conductor holder (Part No. 253 289) and to protect the roof sheeting under the concrete block (Part No. 253 301).



Part No.	253 300
Diameter Ø	300 mm
Diameter Ø of lock bush	10 mm
Height	60 mm
Material	plastic
Colour	grey ●
PU	24 pc(s)

Conductor holder

Conductor holder with slotted saddle clamp for HVI light Conductor, HVI Conductor for mounting in concrete base (Part No. 102 075) with a wedge.



Part No.	253 279
Material	StSt
Conductor support Rd	20 / 23 mm
Height of conductor holder	125 mm
Bolt	Ø16 mm (wedge-fit)
PU	1 pc(s)

Concrete base

With fixing wedge, for air-termination tips Ø10, length 1000 mm or DEHNiso spacers Ø16 mm, length up to 675 mm (distance 0.8 m) or conductor holder (Part No. 253 279).



Part No.	102 075
Total weight	8.5 kg
Diameter Ø	240 mm
Material	concrete (C45/55)
Material of wedge / adapter	StSt
PU	120 pc(s)

Base plate

To protect the roof sheeting under the concrete base. For concrete bases (Part Nos. 102 075, 102 003).



Part No.	102 060
Outside diameter Ø	280 mm
Inside diameter Ø	270 mm
Material	EVA
Colour	black ●
PU	1 pc(s)

EB clamp

For connecting the special sheath of the HVI Conductor to the equipotential bonding.

Part No.	405 020
Material of cage clamp	St/tZn
Clamping range Ø	20 mm
Terminal cross-section	4-95 mm ²
PU	1 pc(s)



Spacer with EB element for HVI Conductor (length of variable sealing end 350-900 mm)

Spacer for establishing the variable sealing end of the HVI Conductor. With MV clamp for connection to the equipotential bonding (Rd 16 mm / Rd 8-10 mm). Concrete base (Part No. 102 010, weight 17 kg) and base plate (Part No. 102 050) must be ordered separately.

Part No.	105 461
Material of spacer	Al
Length of spacer	1270 mm
Conductor support Rd	20 mm
Material of conductor holder	StSt
Length of variable sealing end	350-900 mm
Max. gust wind speed (1 base 17 kg each; l = 900 mm)	105 km/h
Max. gust wind speed (2 bases 17 kg each; l = 900 mm)	150 km/h
PU	1 pc(s)



Variable tripod with EB element for HVI Conductor (length of variable sealing end 900-1500 mm)

Tripod (hinged) with variable spacer for establishing the sealing end of the HVI Conductor. With UNI earthing clamp for connecting 1x Rd 8-10 mm and 1x conductor 4-50 mm². Adjustable to the roof inclination up to max. 10°.

The **three concrete bases** (Part No. 102 075, weight 8.5 kg) and the **base plate** (Part No. 102 060) must be ordered separately.

Part No.	105 469
Material of tripod	StSt
Radius	320 mm
Number of concrete bases	3 (8.5 kg each)
Conductor support Rd	20 mm
Adjustment range of spacer	600-1180 mm
Length of variable sealing end	900-1500 mm
Max. gust wind speed (3 bases 8.5 kg each; l = 900 mm)	180 km/h
Max. gust wind speed (3 bases 8.5 kg each; l = 1500 mm)	110 km/h
PU	1 pc(s)



Spacer for HVI Conductor

Spacer for additional mechanical fixing in the variable sealing end range. The spacer is erected with **two concrete bases** (Part No. 102 010, weight 17kg). The concrete bases and the **base plate** (Part No. 102 050) must be ordered separately.

Part No.	106 815
Material of spacer	GRP
Material of conductor holder / adapter	PA
Number of concrete bases	2 (17 kg each)
Length	1270 mm
Insulating clearance	1245 mm
Conductor support Rd	20 mm
Thread	M8
PU	1 pc(s)



Concrete base

With fixing wedge, stackable, for erecting tripods and air-termination rods Ø16 mm, chamfered or tapered, DEHNiso spacer Ø16 mm or conductor holder (Part No. 253 279).

Part No.	102 010
Weight	17 kg
Support	with fixing wedge Ø16 mm
Diameter Ø	337 mm
Material	concrete (C45/55)
Material of wedge / adapter	StSt
PU	54 pc(s)



Base plate

To protect the roof sheeting under the concrete base. For concrete bases (Part Nos. 102 010, 102 002).

Part No.	102 050
Outside diameter Ø	370 mm
Inside diameter Ø	360 mm
Material	EVA
Colour	black ●
PU	1 pc(s)



Roof conductor holder

With pre-punched points for bending and hooking into the roof tile and screwing onto the battens, for installing the HVI Conductor on gable roofs.



Part No.	202 829
Material of roof conductor holder	StSt
Material of conductor holder	StSt
Conductor support Rd	20 / 23 mm
Length of brace	205 mm
PU	1 pc(s)

Roof conductor holders for roofs with round standing seam

Roof conductor holder with slotted saddle clamp for fixing the HVI light Conductor, HVI Conductor onto metal roofs with round standing seam.



Part No.	202 850
Material (roof conductor holder)	StSt
Material (conductor holder)	StSt
Clamping range	Ø20-25 mm
Conductor support Rd	20 / 23 mm
Standard	EN 62561-4
PU	25 pc(s)

Roof conductor holder for roofs with clamping seam (e.g. RIB-ROOF Speed 500 from Zambelli)

Roof conductor holder with slotted saddle clamp for fixing the HVI light Conductor, HVI Conductor onto metal roofs with clamping seam.



Part No.	202 851
Material of roof conductor holder	StSt
Material of conductor holder	StSt
Clamping range	approx. 18 / 22 mm
Conductor support Rd	20 / 23 mm
Standard	EN 62561-4
PU	25 pc(s)

Roof conductor holder for roofs with standing seam

Roof conductor holder with slotted saddle clamp for fixing the HVI light Conductor, HVI Conductor onto metal roofs with standing seam.



Part No.	202 852
Material of roof conductor holder	StSt
Material of conductor holder	StSt
Clamping range	0.7-8 mm
Conductor support Rd	20 / 23 mm
Standard	EN 62561-4
PU	25 pc(s)

Roof conductor holder with connection lug

Roof conductor holder with slotted saddle clamp for HVI light Conductors, HVI Conductors and Z-shaped connection lug for riveting or screwing to metal roofs.



Part No.	202 853
Material of roof conductor holder	StSt
Material of conductor holder	StSt
Fixing	[4x] Ø5.2 / [2x] Ø6.5 mm
Conductor support Rd	20 / 23 mm
Standard	EN 62561-4
PU	25 pc(s)

Conductor holder with tensioning strap

With conductor holder made of PA.



Part No.	275 330	275 333
Material of conductor holder	PA	PA
Conductor support Rd	20 mm	23 mm
Tensioning range Ø pipe	50-300 mm	50-300 mm
PU	1 pc(s)	1 pc(s)

Conductor holder with tensioning strap

With metal conductor holder.



Part No.	275 320
Material of conductor holder	StSt
Conductor support Rd	20-23 mm
Tensioning range Ø pipe	50-300 mm
PU	1 pc(s)

Conductor holder for fixing with a tensioning strap

For fixing the HVI Conductor to pipes, e.g. with pipe clamp (Part No. 106 323).

Part No.	275 319
Material of conductor holder	StSt
Conductor support Rd	20-23 mm
PU	10 pc(s)



Pipe clamp

For fixing (clamping) conductor holders (e.g. Part No. 275 319).

Part No.	106 323
Material of head / strap	StSt
Clamping range Ø	50-300 mm
Dimensions of strap	1100 x 25 x 0.3 mm
Material of screw	StSt
PU	10 pc(s)



Separate grip head

For combination with endless tensioning strap (Part No. 540 901) in case of larger pipe diameters.

Part No.	106 324
Material of head	StSt
For strap (w x d)	25 x 0.3 mm
Screw	M8 x 20 mm
Material of screw	StSt
PU	20 pc(s)



Tensioning strap

Part No.	540 901
Material	StSt
Strap dimensions (w x d)	25 x 0.3 mm
Length	100 m
Military Name	VG 96953 T05 BB001
PU	1 pc(s)



Conductor holder

With thread. For wall mounting with two-screw clamp (not for use in the sealing end range).

Part No.	275 250	275 251
Material of conductor holder	StSt	StSt
Conductor support Rd	20 / 23 mm	20 / 23 mm
Thread	M8	M6
Standard	EN 62561-4	EN 62561-4
PU	25 pc(s)	25 pc(s)



Conductor holder

With plastic base. For wall mounting with two-screw clamp (not for use in the sealing end range).

Part No.	275 259
Material of conductor holder	StSt
Conductor support Rd	20 / 23 mm
Thread	M8
Standard	EN 62561-4
PU	25 pc(s)



Conductor holder

With slotted hole. For wall mounting with two-screw clamp (not for use in the sealing end range).

Part No.	275 252
Material of conductor holder	StSt
Conductor support Rd	20 / 23 mm
Fixing hole	5.5 x 10 mm
Standard	EN 62561-4
PU	25 pc(s)



Conductor holder for HVI Conductor

For wall mounting and for mounting in the sealing end range.



Part No.	275 220	275 225
Material of conductor holder	PA	PA
Conductor support Rd	20 mm	23 mm
Female thread	M8	M8
Fixing hole	6.5 mm	6.5 mm
Screw	🔩 M6 x 16 mm	🔩 M6 x 16 mm
PU	25 pc(s)	25 pc(s)

Conductor holder for HVI Conductor

For wall mounting with two-screw clamp (not for use in the sealing end range).



Part No.	275 229
Material of conductor holder	StSt
Conductor support Rd	20 mm
Fixing hole	6.5 x 16 mm
Screw	🔩 M6 x 14 mm
PU	50 pc(s)

Conductor holder for HVI Conductor

For wall mounting with two-screw clamp (not for use in the sealing end range).



Part No.	275 239
Material of conductor holder	StSt
Conductor support Rd	23 mm
Fixing hole	6.5 x 16 mm
Screw	🔩 M6 x 14 mm
Standard	EN 62561-4
PU	1 pc(s)

Sign

Front in German ACHTUNG! Getrennter Blitzschutz mit HVI Leitung
Back in English ATTENTION! Separated Lightning Protection with HVI conductor system



Part No.	480 598
Material	plastic
Dimensions (l x w x d)	300 x 210 x 1 mm
Fixing	[4x] Ø6.5 mm
Hole distance	270 / 180 mm
PU	1 pc(s)

Sign

Front in German ACHTUNG! Potentialausgleich
Back in English ATTENTION! Equipotential Bonding
 Hole distance suitable for two-screw clamp (Part No. 480 291).



Part No.	480 599
Material	plastic
Dimensions (l x w x d)	70 x 30 x 1 mm
Fixing	[2x] Ø6.5 mm
Hole distance	38 mm
PU	1 pc(s)

7 Conductor Holders for HVI Conductor in Ex Areas



The HVI Conductor is suitable for use in explosion hazardous areas of Ex zone 1 (gases, vapours, mists) as well as Ex zone 21 (dusts). The special installation conditions safely prevent electric sparks to neighbouring metal parts when lightning current flows through the HVI Conductor.

The HVI Conductor has to be installed in explosion hazardous areas in accordance with the installation instructions.

HVI Ex W70 holder

For fixing to metal structural parts (façades) in Ex zones 1 and 21.



Part No.	275 440
Material	StSt
Conductor support Rd	20 mm
Distance from wall	70 mm
Fixing	[4x] Ø5.1 / [2x] 7 x 10 mm
PU	10 pc(s)

HVI Conductor

HVI Ex W200 holder

For fixing to metal structural parts (façades) in Ex zones 1 and 21.

Part No.	275 441
Material	StSt
Conductor support Rd	20 mm
Distance from wall	200 mm
Fixing	[4x] Ø5.1 / [2x] 7 x 10 mm
PU	10 pc(s)



HVI Ex busbar 500

For installing the HVI Conductor with conductor holders HVI Ex W70 holder (Part No. 275 440) on a non-conductive structure, e.g. stone, wood.

Part No.	275 498
Material of brace	StSt
Fixing	[4x] Ø5.5 / [2x] 7 x 10 mm
Dimension (l x w x d)	450 x 30 x 3 mm
PU	10 pc(s)



HVI Ex P70 holder

For fixing to pipes, e.g. with pipe clamp (Part No. 106 323) in Ex zones 1 and 21.

Part No.	275 444
Material	StSt
Conductor support Rd	20 mm
Distance from wall	70 mm
Clamping range of tube	50-300 mm
PU	10 pc(s)



HVI Ex P200 holder

For fixing to pipes, e.g. with pipe clamp (Part No. 106 323) in Ex zones 1 and 21.

Part No.	275 442
Material	StSt
Conductor support Rd	20 mm
Distance from wall	200 mm
Clamping range of tube	50-300 mm
PU	10 pc(s)



Accessories for Conductor Holders for HVI Conductor in Ex Areas

Pipe clamp

For fixing (clamping) the HVI Ex P200 holder (Part No. 275 442) to pipes.

Part No.	106 323
Material of head / strap	StSt
Clamping range Ø	50-300 mm
Dimensions of strap	1100 x 25 x 0.3 mm
Screw	☒ M8 x 20 mm
Material of screw	StSt
PU	10 pc(s)



Separate grip head

For combination with endless tensioning strap (Part No. 540 901) in case of larger pipe diameters.

Part No.	106 324
Material of head	StSt
For strap (w x d)	25 x 0.3 mm
Screw	☒ M8 x 20 mm
Material of screw	StSt
PU	20 pc(s)



Tensioning strap

Part No.	540 901
Material	StSt
Strap dimensions (w x d)	25 x 0.3 mm
Length	100 m
Military Name	VG 96953 T05 BB001
PU	1 pc(s)



8 Connecting Components 200 kA (10/350 µs)



For use in class of LPS I and II (LPL I, II).
Clamps are tested with a 200 kA (10/350 µs) lightning impulse current, based on EN 62561-1.

UNI disconnecting clamp for two round conductors

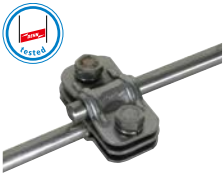

Part No.	459 200
Material	StSt
Clamping range Rd / Rd	10 / 10 mm
Clamping range Rd / FI	10 / 30 mm
Lightning current carrying capability (10/350 µs)	200 kA
Standard	based on EN 62561-1
PU	1 pc(s)

UNI disconnecting clamp for earth entry rods

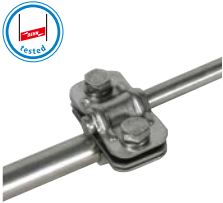

Part No.	459 219
Material	StSt
Clamping range Rd / Rd	8-10 / 16 mm
Lightning current carrying capability (10/350 µs)	200 kA
Standard	based on EN 62561-1
PU	1 pc(s)

Clamping piece

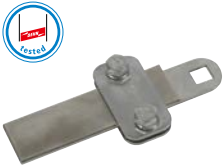

Part No.	380 209
Material	StSt
Clamping range FI	30 x 4 mm
Lightning current carrying capability (10/350 µs)	200 kA
Standard	based on EN 62561-1
PU	1 pc(s)

KS connector



Part No.	301 209
Material	StSt
Clamping range Rd	10 mm
Lightning current carrying capability (10/350 µs)	200 kA
Standard	based on EN 62561-1
PU	1 pc(s)

MV clamp for round conductors



Part No.	390 209
Material	StSt
Clamping range Rd / Rd	8-10 mm
Lightning current carrying capability (10/350 µs)	200 kA
Standard	based on EN 62561-1
PU	1 pc(s)

MV clamp for air-termination rods



Part No.	392 209
Material	StSt
Clamping range Rd / Rd	8-10 / 16 mm
Lightning current carrying capability (10/350 µs)	200 kA
Standard	based on EN 62561-1
PU	1 pc(s)

DECLARATION OF MANUFACTURER

Product: UNI Disconnecting Clamp 200 kA
 Part No. 459 200
 Part No. 459 219

Type: UNI 200 10/350 µs 2P kA
 UNI 200 8/16 2P kA

Manufacturer: Olex 10 - GmbH
 Hans-Otto-Str. 1
 62233 Wiesbaden, Germany

Application

The UNI disconnecting clamps are used as lightning current carrying capable connections from air-termination for or rods to conductors independent from other conductors for the earth system, as per IEC 62561-1:2015 (EN 62561-1:2015) and IEC 62561-2:2015 (EN 62561-2:2015).

We herewith confirm that the UNI disconnecting clamps are suitable for use in Ex zone 2 (ign. hazard) and Ex zone 22 (ign. hazard).

The UNI disconnecting clamps have no potential source of ignition (component of their own) and are thus not subject to the European directive ATEX 2014/54/EU.

Structure, approved according to the European directive ATEX 2014/54/EU is legally impossible and not required from an explosion protection point of view.

Newmarket, September 24th, 2020
 Dr. Ingo Kopp-Reuter
 Director ATEX

9 Stripping tool for HVI light Conductors / HVI Conductors



Tool for stripping the semi-conductive sheath and the PE insulation of the HVI light Conductor, HVI Conductor (outer diameter 20 mm).

- Tool consists of a handle and various exchangeable cutting heads
- Stripping length of HVI light Conductor, HVI Conductor is adjustable in steps of 0.2 mm (lock points) using the knob in the handle. The dial on the handle shows the length set.

Handling

Position the cutting head at the cut off end of the conductor and turn clockwise with light pressure to cut/strip it. The cutting head can be exchanged without tools via the bayonet coupling.

HVI strip 20

For HVI light and HVI Conductors (handle + cutting head).

Part No.	597 220
Diameter Ø conductor	20 mm
Material of moulded part	plastic
Material of blade	StSt
PU	1 pc(s)



HVI head 20

For HVI light and HVI Conductors (cutting head).

Part No.	597 120
Diameter Ø conductor	20 mm
Material of moulded part	plastic
Material of blade	StSt
PU	1 pc(s)



Accessories for Stripping tool for HVI light Conductors / HVI Conductors

HVI head holder

Adapter with bayonet coupling for attaching the HVI head cutting head (pre-set stripping length 35 mm). Adapter can be used in a standard three-jaw chuck (Ø10 mm), e.g. with cordless screwdrivers.

Part No.	597 139
Material	plastic / brass
PU	1 pc(s)



Spare blades for HVI head 20

1 set = 4 blades

Part No.	597 101
Material	StSt
PU	1 set



9 Stripping Tool for HVI light Conductors / HVI Conductors

Tool for stripping the additional grey sheath of the HVI light Conductor and HVI Conductor. DEHNhelix consists of a handle and an exchangeable bracket (depending on the conductor diameter).



DEHNhelix

Part No.	597 230
Diameter Ø conductor	23 mm
Material of moulded part	plastic
Material of blade	StSt
PU	1 pc(s)

Accessory for Stripping Tool for HVI light Conductors / HVI Conductors

Spare blade for stripping tool



Part No.	597 130
Material	StSt
PU	1 pc(s)

9 Cable shears for HVI Conductors



Cable shears for easily cutting the HVI light Conductor, HVI Conductor (outer diameter 20 / 23 mm), HVI power Conductor (outer diameter 27 mm) and CUI Conductor to length.

The special design of the cable shears also allows precise cutting of stranded conductors, making it easier to attach connection elements.

HVI cutter

Part No.	597 032
Diameter Ø conductor	up to 32 mm
Material of blades	tool steel (CR-Moly (SCM440))
Material of handles	carbon steel (SS400)
Length	600 mm
PU	1 pc(s)

10 Sealing End Range, Connection to "Isolated Ring Conductor"



If several installation parts require protection, it is advisable not to route the HVI Conductor of each air-termination system individually to the earth-termination system. The HVI Conductors from the air-termination system can be connected to an "isolated ring conductor". From this "isolated ring conductor" several down conductors, HVI Conductors, can then be led to the earth-termination system. The "isolated ring conductor" must be installed, e.g. on the roof, on spacers and concrete bases, taking the calculated separation distance "s" into account.

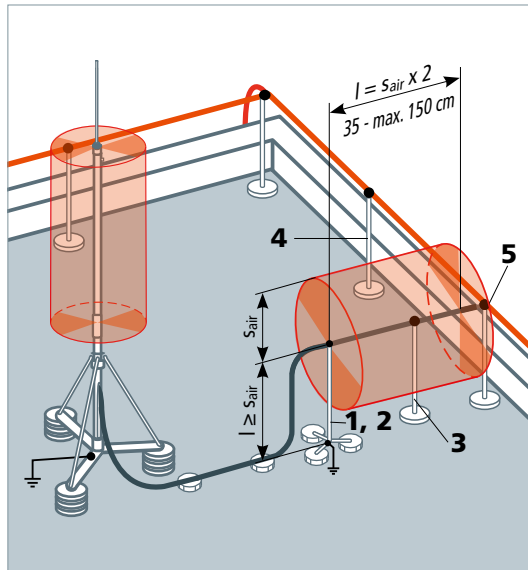
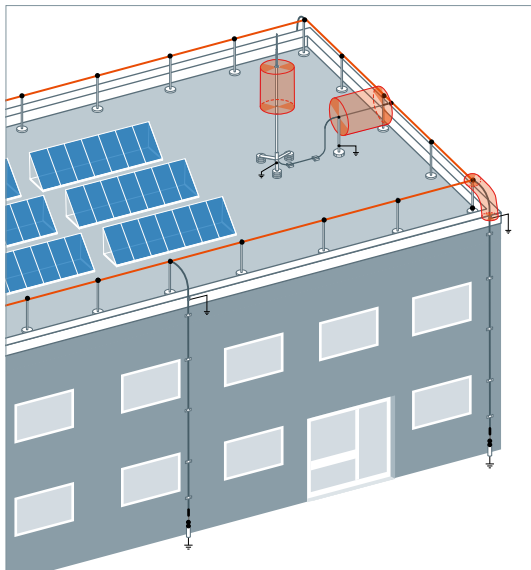

HVI Conductor

Accessories for the Sealing End Range, Connection to "Isolated Ring Conductor"

Spacer with EB element for HVI Conductor (length of variable sealing end 350-900 mm)

Spacer for establishing the variable sealing end of the HVI Conductor.
 With MV clamp for connection to the equipotential bonding (Rd 16 mm / Rd 8-10 mm).
 Concrete base (Part No. 102 010, weight 17 kg) and base plate (Part No. 102 050) must be ordered separately.

Part No.	105 461
PU	1 pc(s)

Variable tripod with EB element for HVI Conductor (length of variable sealing end 900-1500 mm)

Tripod (hinged) with variable spacer for establishing the sealing end of the HVI Conductor.
 With UNI earthing clamp for connecting 1x Rd 8-10 mm and 1x conductor 4-50 mm²
 Adjustable to the roof inclination of max. 10°.
 The **three concrete bases** (Part No. 102 075, weight 8.5 kg) and the **base plate** (Part No. 102 060) must be ordered separately.

Part No.	105 469
PU	1 pc(s)

Spacer for HVI Conductor

Spacer for additional mechanical fixing in the variable sealing end range. The spacer is erected with **two concrete bases** (Part No. 102 010, weight 17 kg). The concrete bases and the **base plate** (Part No. 102 050) must be ordered separately.

Part No.	106 815
PU	1 pc(s)

DEHNiso spacers with MMV clamp

For crossing points, when installed in a concrete base (Part No. 102 075), fixed conductor routing.

Part No.	106 150
PU	1 pc(s)

MV clamp

With hexagon screw, spring washer and thread in the base part. Lightning current carrying capability 200 kA (10/350 µs).

Part No.	390 209
PU	1 pc(s)





10 Sealing End Range, Connection to "Capping of Roof Parapet"

If several installation parts require protection, it is advisable not to route the HVI Conductor of each air-termination system individually to the earth-termination system. The HVI Conductors from the air-termination system can be connected to the capping of the roof parapet which serves as a ring conductor. From the capping of the roof parapet several down conductors can then be routed to the earth-termination system.

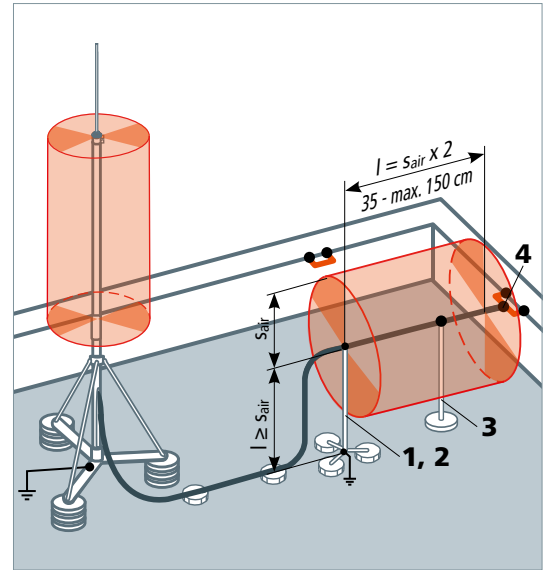
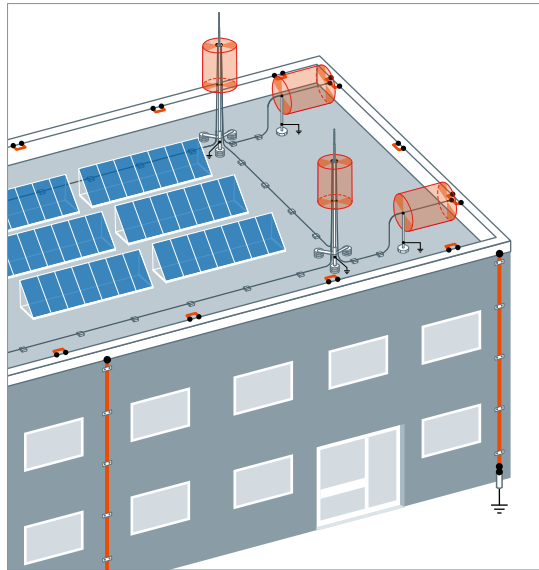

Accessories for the Sealing End Range, Connection to "Capping of Roof Parapet"

1



Spacer with EB element for HVI Conductor (length of variable sealing end 350-900 mm)

Spacer for establishing the variable sealing end of the HVI Conductor.
With MV clamp for connection to the equipotential bonding (Rd 16 mm / Rd 8-10 mm).
Concrete base (Part No. 102 010, weight 17 kg) and base plate (Part No. 102 050) must be ordered separately.

Part No.	105 461
PU	1 pc(s)

2



Variable tripod with EB element for HVI Conductor (length of variable sealing end 900-1500 mm)

Tripod (hinged) with variable spacer for establishing the sealing end of the HVI Conductor.
With UNI earthing clamp for connecting 1x Rd 8-10 mm and 1x conductor 4-50 mm²
Adjustable to the roof inclination of max. 10°.
The **three concrete bases** (Part No. 102 075, weight 8.5 kg) and the **base plate** (Part No. 102 060) must be ordered separately.

Part No.	105 469
PU	1 pc(s)

3



Spacer for HVI Conductor

Spacer for additional mechanical fixing in the variable sealing end range.
The spacer is erected with **two concrete bases** (Part No. 102 010, weight 17 kg). The concrete bases and the **base plate** (Part No. 102 050) must be ordered separately.

Part No.	106 815
PU	1 pc(s)

4



KS connector

With M10 screw and nut.
Lightning current carrying capability 200 kA (10/350 μs).

Part No.	301 209
PU	1 pc(s)

10 Sealing End Range on a Building Structure

If the HVI Conductor is installed on a building structure, the calculated separation distance "s" in the sealing end range from the metal parts in the building structure must be maintained. The sealing end range reaches from the EB connection element to the earth connection element. If the HVI Conductor is directly connected with an earth entry rod / earth-termination system, an EB element is not necessary. The sealing end range thus also remains unconsidered.

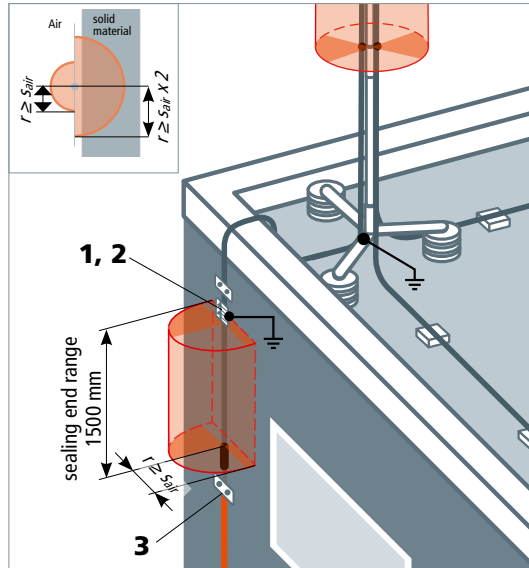
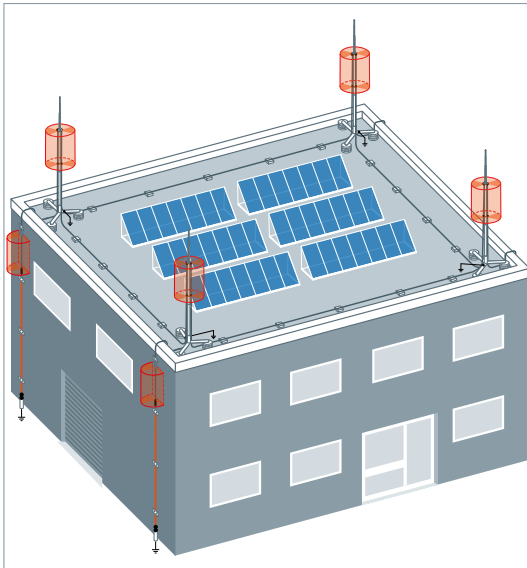

HVI Conductor

Accessories for the Sealing End Range on a Building Structure

EB connection element for HVI long Conductor

For discharging the electric field of the HVI long Conductor in the sealing end range. Special slotted design to electrically contact the semi-conductive sheath.

Part No.	410 229
PU	1 pc(s)



KS connector

With screw and nut M10.

Part No.	301 019
PU	100 pc(s)



Disconnecting clamp

Disconnecting clamp with spring washer for connecting the HVI power Conductor with the earth entry rod. Lightning current carrying capability 200 kA (10/350 μs).

Part No.	459 200
PU	1 pc(s)

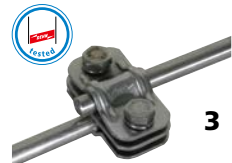

HVI power Conductor

The HVI power Conductor is the most powerful variant of the high-voltage-resistant, insulated down conductors (HVI Conductors). Unlike the standard HVI Conductor, it allows one to maintain an equivalent separation distance of 0.9 m in air and 1.8 m in solid material. It is particularly important to point out that the HVI power Conductor and the corresponding components are tested for a lightning current carrying capability of up to 200 kA (10/350 μ s) based on EN 62561-1. Therefore, this type of conductor may be used for all classes of LPS (I-V).

This conductor is installed, above all, on buildings such as hospitals, computing centres or silos where large separation distances need to be maintained due to the building dimensions (height). Moreover, the conductor routing to the earth-termination system can be longer.

The conductor can be installed inside a stainless steel or aluminium supporting tube. The internal sealing end spring element automatically contacts the semi-conductive sheath and thus provides the sealing end. The functional equipotential bonding is directly connected to the metal supporting tube and the structure. When using GRP/Al supporting tubes, another HVI power Conductor can be installed outside using a connection kit.

HVI power Conductor (pre-assembled)

In case of the pre-assembled HVI power Conductors, inside as well as outside installation, the head piece is already assembled and shrink wrapped. The other conductor end can be exactly positioned to suit the structure of system using the loosely delivered connection element. Minimum order length is 6 m, additional conductor lengths in steps of 0.5 m (max. 35 m). Conductor length to be indicated when ordering.

HVI power long Conductor (on plywood reel / cut to length)

The HVI power long Conductor for on-site assembly is available in a length of 100 m on a disposable plywood reel (diameter approx. 900 mm, width approx. 485 mm) or cut to length (6-35 m or 36-80 m). The installer determines the required lengths, cuts to length and assembles the sealing ends on site.

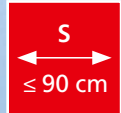

Technical data	HVI power Conductor (pre-assembled)	HVI power long Conductor (on plywood reel)	HVI power long Conductor (cut to length)
Structure	stranded	stranded	stranded
Cross-section of inner conductor (Cu)	25 mm ²	25 mm ²	25 mm ²
Colour	black	black	black
Outer diameter	27 mm	27 mm	27 mm
Equivalent separation distance (air)	≤ 90 cm	≤ 90 cm	≤ 90 cm
Equivalent separation distance (solid material)	≤ 180 cm	≤ 180 cm	≤ 180 cm
Minimum bending radius (OD = outer diameter)	10 x OD, 270 mm black	10 x OD, 270 mm black	10 x OD, 270 mm black
Operating temperature	-50 °C ... +70 °C	-50 °C ... +70 °C	-50 °C ... +70 °C
Temperature for installation	-5 °C ... +40 °C	-5 °C ... +40 °C	-5 °C ... +40 °C
Tensile strength	1200 N	1200 N	1200 N
UV stability / weather resistance	yes	yes	yes
Tested with I _{imp} (10/350 μ s) based on EN 62561-1	200 kA	200 kA	200 kA
For use in class of LPS in case of a single down conductor without current distribution (k _c = 1)	I, II, III, IV	I, II, III, IV	I, II, III, IV
Installation in Ex zone 1 and 21	allowed	allowed	allowed
Minimum order quantity	≥ 6 m	100 m	≥ 6 / ≥ 36 m
Max. order length	35 m	—	35 / 80 m
Cable weight / 100 m	—	~ 73 kg	—

Partly isolated lightning protection system for an industrial building

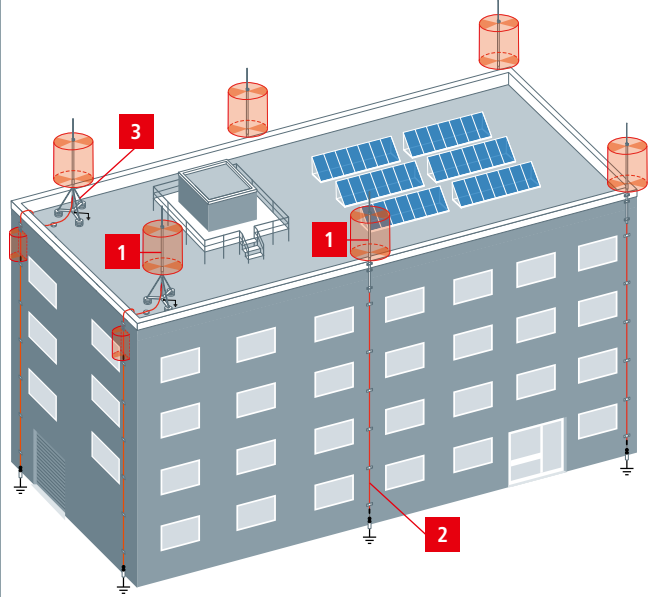

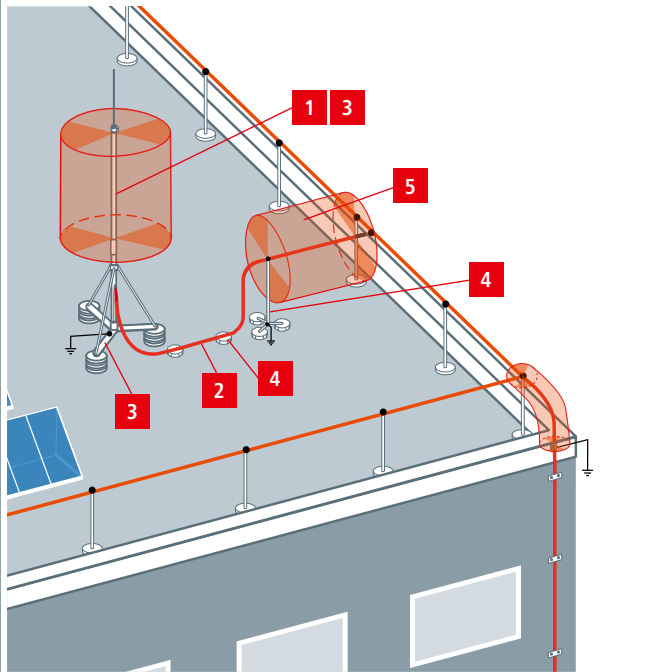

Self-supporting HVI power system

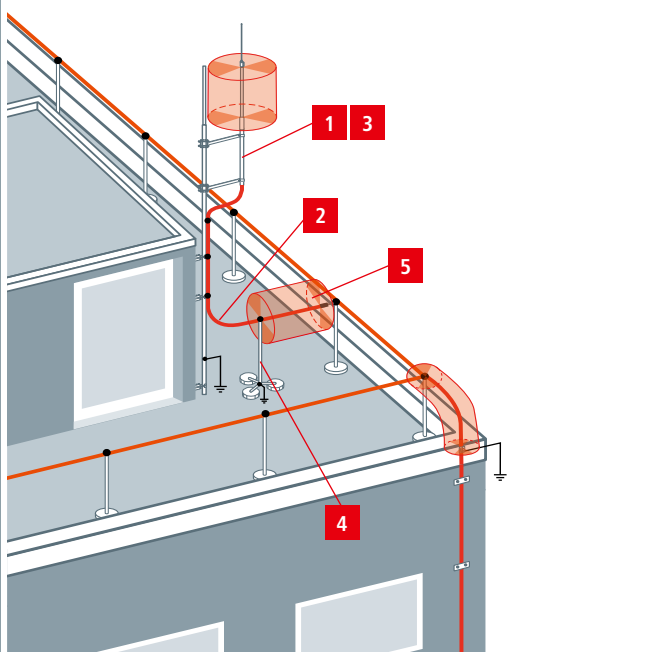

HVI power Conductor mounted on an antenna pole



Product	Product name
<p>1</p> 	<p>Supporting Tubes with HVI power Conductor</p> <p>see Page 196</p>
<p>2</p> 	<p>HVI power Conductor Connection Elements</p> <p>see Page 197</p>
<p>3</p> 	<p>Supporting Tubes for HVI power Conductors Tripods Accessories for Tripods</p> <p>see Page 198</p>
<p>4</p> 	<p>Fixing Elements for Tripods</p> <p>see Page 202</p>
<p>5</p> 	<p>Sealing End Ranges</p> <p>see Page 213</p>

HVI power Conductor

1 Supporting Tube with HVI power Conductor



Optically optimised installation of the HVI power Conductor inside the supporting tube creates less wind exposed area. Can be used up to an equivalent separation distance $s \leq 90$ cm (in air) or $s \leq 180$ cm (solid material). The conductor length has to be stated when ordering (in steps of 0.5 m).



HVI power Conductor inside the supporting tube with air-termination tip

Supporting tube with internal sealing end and EB spring element. Air-termination tip, StSt, $\varnothing 10$ mm, length 1000 mm.



Part No.	819 430
Material of supporting tube	GRP / StSt
Length of supporting tube	3500 mm
Transport length	3500 mm
Diameter \varnothing conductor	27 mm
Colour of conductor	black ●
Material of conductor	Cu
Minimum order length	6 m
Maximum order length	35 m
Suitable for installation outside the supporting tube	no
Max. free length with air-termination tip (wall mounting)	3500 mm
Max. gust wind speed (wall mounting, 1x HVI power inside)	235 km/h
PU	1 pc(s)



HVI power Conductor inside the supporting tube with air-termination rod

Supporting tube with internal sealing end and EB spring element. Air-termination rod, StSt, $\varnothing 22 / 16 / 10$ mm, length 2500 mm.



Part No.	819 431	819 433
Material of supporting tube	GRP / StSt	GRP / StSt
Length of supporting tube	3500 mm	5000 mm
Transport length	3500 mm	5000 mm
Diameter \varnothing conductor	27 mm	27 mm
Colour of conductor	black ●	black ●
Material of conductor	Cu	Cu
Minimum order length	6 m	6 m
Maximum order length	35 m	35 m
Suitable for installation outside the supporting tube	no	no
Max. free length with air-termination rod (wall mounting)	5000 mm	5000 mm
Max. gust wind speed (wall mounting, 1x HVI power inside)	169 km/h	169 km/h
PU	1 pc(s)	1 pc(s)

The conductor cannot be returned as it is made to order.
Max. gust wind speed (tripod with supporting tube) see table on page 140.

Air-termination Mast with HVI power Conductor



For a maximum free length of the whole air-termination system of 8.5 m.
To be fixed with three variable supports (Part No. 105 345). Transport length 6000 mm.

With 1x HVI power Conductor inside the supporting tube. Conductor length has to be stated when ordering (steps of 0.5 m). Maximum total length of the HVI power Conductor 11.0 m in case of class of LPS I. Maximum total length of the HVI power Conductor 15.0 m in case of class of LPS II. Maximum total length of the HVI power Conductor 22.5 m in case of class of LPS III.



Part No.	819 760
Total length of air-termination mast	11000 mm
Length of air-termination rod	3000 mm
Length of supporting tube	2300 mm
Length of mast pipe	6000 mm
Diameter \varnothing conductor	27 mm
Colour of conductor	black ●
Material of conductor	Cu
Minimum order length	10 m
Maximum order length	35 m
Suitable for installation outside tube	no
Max. gust wind speed	147 km/h
PU	1 pc(s)

Accessory for Air-termination Mast with HVI power Conductor

Variable support for air-termination masts

Three supports should be mounted for each air-termination mast. Clamping range of air-termination mast $\varnothing 60$ mm.



Part No.	105 345
Material of support	St/tZn
Adjustment range	250-350 mm
Fixing holes \varnothing	[4x] 12 x 25 mm
PU	1 pc(s)

2 HVI power Conductor



High-voltage-resistant, insulated down conductor for maintaining the separation distance from conductive parts according to IEC/EN 62305-3. For use up to an equivalent separation distance $s \leq 90$ cm (in air) or $s \leq 180$ cm (solid material).

HVI power Conductor (pre-assembled, installation inside the tube)

With one head piece and one connection element (enclosed loose). Minimum order length 6 m, conductor length has to be stated when ordering (in steps of 0.5 m).

Part No.	819 160
Material of conductor	Cu
Material of insulation	PE
Material of sheath	PE
Colour of conductor	black ●
Diameter Ø conductor	27 mm
Minimum order length	6 m
Maximum order length	35 m
PU	1 pc(s)



HVI power Conductor (pre-assembled, installation outside the tube) for HVI power supporting tube GRP / Al

HVI power Conductor pre-assembled for installation outside the tube with one head piece and one connection element (enclosed loose). Connection kit for installing the HVI power Conductor on HVI power supporting tubes GRP / Al consists of threaded pins, a connection part, heat-shrinkable sleeve and fixing ring with slotted conductor holder (Ø27 mm) for the sealing end (including cable ties). Minimum order length 6 m, conductor length has to be stated when ordering (in steps of 0.5 m).

Part No.	819 165
Material of conductor	Cu
Material of insulation	PE
Material of sheath	PE
Colour of conductor	black ●
Diameter Ø conductor	27 mm
Minimum order length	6 m
Maximum order length	35 m
PU	1 pc(s)



HVI power Conductor

HVI power long Conductor (on a reel)

The HVI power long Conductor for on-site assembly comes in a length of 100 m on a disposable plywood reel (diameter approx. 900 mm, width approx. 485 mm). Allen key included in delivery.

Part No.	819 137
Material of conductor	Cu
Material of insulation	PE
Material of sheath	PE
Colour of conductor	black ●
Diameter Ø conductor	27 mm
PU	100 m



HVI power long Conductor (cut to length)

Cut-to-length HVI power long Conductor cut for on-site assembly. The conductor is delivered as a coil (Part No. 819 163) or on a reel (Part No. 819 161). Conductor length to be indicated when ordering (in steps of 0.5 m).

Part No.	819 163	819 161
Material of conductor	Cu	Cu
Material of insulation	PE	PE
Material of sheath	PE	PE
Colour of conductor	black ●	black ●
Diameter Ø conductor	27 mm	27 mm
Minimum order length	6 m	36 m
Maximum order length	35 m	80 m
PU	1 pc(s)	1 pc(s)



2 Connection Elements for HVI power Conductor / HVI power long Conductors



Connection kit for HVI power long Conductor Ø27 mm for installation inside the tube

Connection elements for sealing the HVI power long Conductor at both ends, for implementing the sealing end of the conductor in the supporting tube (head piece) and connection element for connection with other parts of the external lightning protection system or earth-termination system (including two heat-shrinkable sleeves).

Part No.	819 142
Material	StSt
Connection	bolt Ø10 mm, L 50 mm
Outside diameter Ø	30 mm
Screw	threaded bolt M6 x 8 mm
PU	1 pc(s)

Connection kit for HVI power long Conductor Ø27 mm for installation outside the tube

Connection kit for HVI power Conductor for installation on HVI power supporting tubes GRP / Al consisting of connection elements, threaded pins, connection part, heat-shrinkable sleeves, cable ties and fixing ring with a slotted conductor holder (Ø27 mm).



Part No.	819 149
Material	StSt
Connection	bolt Ø10 mm, L 50 mm
Outside diameter Ø	30 mm
Screw	threaded bolt M6 x 8 mm
PU	1 pc(s)

EB connection element for HVI power Conductor / HVI power long Conductor

For discharging the electric field of the HVI power Conductor (pre-assembled / on a reel) in the sealing end range. Special slotted design to electrically contact the semi-conductive sheath.



Part No.	410 239
Material	StSt
Clamping range Ø	27 mm
Connection hole Ø	11 mm
Screw	M10 x 20 mm
PU	1 pc(s)

3 Supporting Tubes for HVI power Conductor / HVI power long Conductors



With air-termination tip

Supporting tube with internal sealing end and EB spring element. Air-termination tip, StSt, Ø10 mm, length 1000 mm.



Part No.	105 563	105 565	105 320	105 322
Material of supporting tube	GRP / Al	GRP / Al	GRP / StSt	GRP / StSt
Length of supporting tube	3500 mm	5000 mm	3500 mm	5000 mm
Outside diameter Ø	50 mm	50 mm	50 mm	50 mm
Transport length	3500 mm	5000 mm	3500 mm	5000 mm
Length of insulating clearance	1800 mm	1800 mm	1800 mm	1800 mm
Suitable for installation outside the tube	yes	yes	no	no
Max. free length with air-termination tip (wall mounting)	4000 mm	4000 mm	4000 mm	4000 mm
Max. gust wind speed (wall mounting, 1x HVI power inside)	203 km/h	203 km/h	235 km/h	235 km/h
Max. gust wind speed (wall mounting, 1x HVI power inside + 1x HVI power outside)	181 km/h	181 km/h	—	—
PU	1 pc(s)	1 pc(s)	1 pc(s)	1 pc(s)

With air-termination rod

Supporting tube with internal sealing end and EB spring element. Air-termination rod, StSt, Ø22 / 16 / 10 mm, length 2500 mm.



Part No.	105 573	105 575	105 321	105 323
Material of supporting tube	GRP / Al	GRP / Al	GRP / StSt	GRP / StSt
Length of supporting tube	3500 mm	5000 mm	3500 mm	5000 mm
Outside diameter Ø	50 mm	50 mm	50 mm	50 mm
Transport length	3500 mm	5000 mm	3500 mm	5000 mm
Length of insulating clearance	1800 mm	1800 mm	1800 mm	1800 mm
Suitable for installation outside the tube	yes	yes	no	no
Max. free length with air-termination rod (wall mounting)	5500 mm	5500 mm	5500 mm	5500 mm
Max. gust wind speed (wall mounting, 1x HVI power inside)	173 km/h	173 km/h	169 km/h	169 km/h
Max. gust wind speed (wall mounting, 1x HVI power inside + 1x HVI power outside)	155 km/h	155 km/h	—	—
PU	1 pc(s)	1 pc(s)	1 pc(s)	1 pc(s)

With air-termination tip and side outlet

Supporting tube with internal sealing end and EB spring element. Air-termination tip, StSt, Ø10 mm, length 1000 mm.

Part No.	105 513	105 515	105 392	105 394
Material of supporting tube	GRP / Al	GRP / Al	GRP / StSt	GRP / StSt
Length of supporting tube	3500 mm	5000 mm	3500 mm	5000 mm
Outside diameter Ø	50 mm	50 mm	50 mm	50 mm
Transport length	3500 mm	5000 mm	3500 mm	5000 mm
Length of insulating clearance	1800 mm	1800 mm	1800 mm	1800 mm
Suitable for installation outside the tube	yes	yes	no	no
PU	1 pc(s)	1 pc(s)	1 pc(s)	1 pc(s)

Max. gust wind speed (tripod with supporting tube) see table on page 140.



With air-termination rod and side outlet

Supporting tube with internal sealing end and EB spring element. Air-termination rod, StSt, Ø22 / 16 / 10 mm, length 2500 mm.

Part No.	105 543	105 545	105 393	105 395
Material of supporting tube	GRP / Al	GRP / Al	GRP / StSt	GRP / StSt
Length of supporting tube	3500 mm	5000 mm	3500 mm	5000 mm
Outside diameter Ø	50 mm	50 mm	50 mm	50 mm
Transport length	3500 mm	5000 mm	3500 mm	5000 mm
Length of insulating clearance	1800 mm	1800 mm	1800 mm	1800 mm
Suitable for installation outside the tube	yes	yes	no	no
PU	1 pc(s)	1 pc(s)	1 pc(s)	1 pc(s)

Max. gust wind speed (tripod with supporting tube) see table on page 140.



Accessories for Supporting Tubes for HVI power Conductors / HVI power long Conductors

Sideways air-termination tips Al for supporting tubes

Fixing kit for mounting sideways/horizontal air-termination tips on HVI long supporting tubes and HVI power supporting tubes. Consisting of four air-termination tips and one fixing ring.

Note: The additional wind load on the air-termination system with the horizontally mounted air-termination tips must be observed!

Part No.	819 183	819 185
Length of air-termination tip	530 mm	1030 mm
Material of air-termination tip	Al	Al
Material of fixing ring	Al	Al
PU	1 pc(s)	1 pc(s)



Sideways air-termination tips StSt for supporting tubes

Fixing kit for mounting sideways/horizontal air-termination tips on HVI long supporting tubes and HVI power supporting tubes. Consisting of four air-termination tips and one fixing ring.

Note: The additional wind load on the air-termination system with the horizontally mounted air-termination tips must be observed!

Part No.	819 184	819 186
Length of air-termination tip	530 mm	1030 mm
Material of air-termination tip	StSt	StSt
Material of fixing ring	StSt	StSt
PU	1 pc(s)	1 pc(s)



3 Tripods for Supporting Tubes without Side Outlet

Special design for HVI Conductors installed inside / outside the supporting tube, with double clamp for connecting 2x Rd 8-10 mm. For keeping the bending radius of the HVI Conductor (installed inside the supporting tube) at the bottom of the tripod, two concrete bases are positioned below and one above the brace. Adjustable to a roof inclination up to max. 10°. The stackable concrete base (Part No. 102 010) and the support plate (Part No. 102 050) must be ordered separately.

Note: Contact us to find out whether the material of the roof conductor holders or base plates are compatible with the roof elements.

Tripod small

Suitable for supporting tube with HVI power Conductor inside the supporting tube.

Part No.	105 351
Material of tripod	St/tZn
Support	50 mm
Radius	620 mm
Number of concrete bases	3-12 blocks 17 kg each
Space required for tripod	1300 x 1450 mm
PU	1 pc(s)



Tripod large

Suitable for supporting tube with HVI power Conductor outside the supporting tube.



Part No.	105 201
Material of tripod	St/tZn
Support	40 / 50 mm
Radius	1435 mm
Quantity of concrete bases	3-12 blocks 17 kg each
Space required for tripod	2520 x 2860 mm
PU	1 pc(s)

Accessories for Tripods for Supporting Tubes without Side Outlet

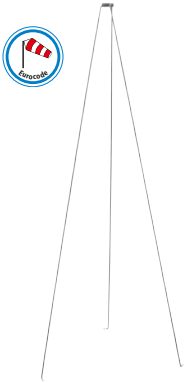

Bracing

Bracing, 3-fold with clamp for tubes D 50 mm for fixing onto the tripod (Part No. 105 201). Bracing suitable for supporting tubes with a length of 4700 mm (e.g. Part Nos. 105 332, 105 316, 105 333, 105 317, 105 322, 105 323, 105 565, 105 575).

Part No.	105 601
Material	StSt
Brace length	2910 mm
Ø clamp	50 mm
PU	1 pc(s)

Concrete base

With fixing wedge, stackable, for erecting tripods and air-termination rods Ø16 mm, chamfered or tapered, DEHNiso spacer Ø16 mm or conductor holder (Part No. 253 279).



Part No.	102 010
Weight	17 kg
Support	with fixing wedge Ø16 mm
Diameter Ø	337 mm
Material	concrete (C45/55)
Material of wedge / adapter	StSt
PU	54 pc(s)

Concrete base

Concrete base without wedge, for erecting tripods.



Part No.	102 012
Weight	17 kg
Support	Ø16 mm
Diameter Ø	337 mm
Material	concrete (C45/55)
PU	54 pc(s)

Base plate

To protect the roof sheeting under the concrete base.
For concrete bases (Part Nos. 102 010, 102 002).



Part No.	102 050
Outside diameter Ø	370 mm
Inside diameter Ø	360 mm
Material	EVA
Colour	black ●
PU	1 pc(s)

HVI power Conductor

3 Tripods for Supporting Tubes with Side Outlet

Special design for supporting tube with HVI Conductor installed inside, with side outlet and double clamp for connection of 2x Rd 8-10 mm. Adjustable to the roof inclination up to max. 5°



The stackable concrete base (Part No. 102 012) and the base plate (Part No. 102 050) as well as the threaded rod sets (Part Nos. 105 396-105 398 or Part Nos. 105 496-105 498) must be ordered separately.

Tripod small

Part No.	105 390
Material	StSt
Support	50 mm
Radius	600 mm
Space required for stand	1400 x 1200 mm
PU	1 pc(s)



Tripod large

Part No.	105 391
Material	StSt
Support	50 mm
Radius	1450 mm
Space required for stand	2900 x 2500 mm
PU	1 pc(s)



Four-legged stand, small

Part No.	105 490
Material	StSt
Support	50 mm
Radius	600 mm
Space required for stand	1200 x 1200 mm
PU	1 pc(s)



Four-legged stand, large

Part No.	105 491
Material	StSt
Support	50 mm
Radius	1450 mm
Space required for stand	2400 x 2400 mm
PU	1 pc(s)



HVI power Conductor

Accessories for Tripods for Supporting Tubes with Side Outlet

Set of threaded rods for tripod

Consisting of three threaded rods, each with 2 nuts and a spring washer.

Part No.	105 396	105 397	105 398
For tripod	Part No. 105 390 / 105 391	Part No. 105 390 / 105 391	Part No. 105 390 / 105 391
Number of concrete blocks	1 to 2	1 to 3	3 to 4
Material	StSt	StSt	StSt
Length	M16 x 340 mm	M16 x 520 mm	M16 x 650 mm
PU	1 pc(s)	1 pc(s)	1 pc(s)



Set of threaded rods for four-legged stand

Consisting of four threaded rods, each with 2 nuts and a spring washer.

Part No.	105 496	105 497	105 498
For four-legged stand	Part No. 105 490 / 105 491	Part No. 105 490 / 105 491	Part No. 105 490 / 105 491
Number of concrete blocks	1 to 2	1 to 3	3 to 4
Material	StSt	StSt	StSt
Length	M16 x 340 mm	M16 x 520 mm	M16 x 650 mm
PU	1 pc(s)	1 pc(s)	1 pc(s)



Concrete base

Concrete base without wedge, for erecting tripods.



Part No.	102 012
Weight	17 kg
Support	Ø16 mm
Diameter Ø	337 mm
Material	concrete (C45/55)
PU	54 pc(s)

Base plate

To protect the roof sheeting under the concrete base. For concrete bases (Part Nos. 102 010, 102 002).



Part No.	102 050
Outside diameter Ø	370 mm
Inside diameter Ø	360 mm
Material	EVA
Colour	black ●
PU	1 pc(s)

4 Fixing Elements for Supporting Tubes

Fixing clamp with tensioning strap

For fixing supporting tubes to structural elements, e.g. antenna masts.



Part No.	105 360
Material of clip	StSt
Clamping range for supporting tube	50 mm
Clamping range for pipe Ø	50-300 mm
Material of tensioning strap	StSt
Dimensions of strap (w x d)	25 x 0.3 mm
PU	1 pc(s)

Fixing clamp with tensioning strap

With additional spacer for adjusting the sector antenna holders to the mast.



Part No.	105 361
Material of clip	StSt
Clamping range for supporting tube	50 mm
Clamping range for pipe Ø	50-300 mm
Material of tensioning strap	StSt
Dimensions of strap (w x d)	25 x 0.3 mm
Length of spacer	30 mm
PU	1 pc(s)

Fixing clamp with tensioning strap

With additional long spacer for adjusting sector antenna holders to the mast.



Part No.	105 362
Material of clip	StSt
Clamping range for supporting tube	50 mm
Clamping range for pipe Ø	50-300 mm
Material of tensioning strap	StSt
Dimensions of strap (w x d)	25 x 0.3 mm
Length of spacer	95 mm
PU	1 pc(s)

Wall mounting bracket for horizontal mounting, flat

For fixing supporting tubes onto the structure to be protected or the wall.



Part No.	105 340
Material	StSt
Clamping range for supporting tube	50 mm
Distance from wall / corner	80 mm
Dimensions of fixing	320 mm
Fixing	[8x] Ø5.1 / [4x] 11 x 20 mm
PU	1 pc(s)

Wall mounting bracket for horizontal mounting, corner

For fixing supporting tubes onto the structure to be protected or the wall.

Part No.	105 341
Material	StSt
Clamping range for supporting tube	50 mm
Distance from wall / corner	80 mm
Dimensions of fixing	152 mm
Fixing	[8x] Ø5.1 / [4x] 11 x 20 mm
PU	1 pc(s)



Wall mounting bracket for vertical mounting

For fixing supporting tubes or air-termination rods D40 / D50 to roof-mounted structures or walls.

Part No.	105 342	105 348
Material of bracket	StSt	StSt
Fixing	[8x] Ø5.1 / [4x] 7 x 10 / [2x] 11 x 20 mm	[8x] Ø5.1 / [4x] 7 x 10 / [2x] 11 x 20 mm
Clamping range for supporting tube	40-50 mm	40-50 mm
Distance from wall	46 mm	110 mm
PU	1 pc(s)	1 pc(s)



Wall mounting bracket, adjustable from 150-200 mm

For fixing supporting tubes or air-termination rods D40 / D50 with double clamp, for the connecting 2x Rd 8-10 mm.

Part No.	105 344
Material of bracket	StSt
Clamping range for supporting tube	40-50 mm
Distance from wall	150-200 mm
Dimensions of plate	120 x 120 x 4 mm
Fixing	[4x] 12 x 26 mm
Standard	EN 62561-1
PU	1 pc(s)



Wall mounting bracket, adjustable from 230-1300 mm

For fixing supporting tubes or air-termination rods D40 / D50.

Part No.	105 347	105 343	105 349
Material of bracket	St/tZn / StSt	St/tZn / StSt	St/tZn / StSt
Clamping range for supporting tube	40-50 mm	40-50 mm	40-50 mm
Distance from wall	230-400 mm	400-700 mm	700-1300 mm
Dimensions of plate	120 x 120 x 4 mm	120 x 120 x 4 mm	120 x 120 x 4 mm
Fixing	[4x] 12 x 26 mm	[4x] 12 x 26 mm	[4x] 12 x 26 mm
PU	1 pc(s)	1 pc(s)	1 pc(s)



Railing clamp

For pipes.

Part No.	105 354	105 355
Material	StSt	StSt
Clamping range for pipe Ø	48-60 mm (1½-2")	70-90 mm (2¼-3")
Clamping range for supporting tube	40-50 mm	40-50 mm
PU	5 pc(s)	1 pc(s)



Railing clamp

For square hollow profiles.

Part No.	105 356	105 376
Material	StSt	StSt
Clamping range for square profile	20 x 20 to 50 x 50 mm	60 x 120 mm
Clamping range for supporting tube	40-50 mm	40-50 mm
PU	5 pc(s)	1 pc(s)



Spacers for Omnidirectional Antennas



Spacer for DEHNiso Combi supporting tubes with HVI Conductor installed inside and/or outside the supporting tube, mounted on the antenna mast.



Part No.	105 363	105 364	105 365
Material of support / square profile	St/tZn	St/tZn	St/tZn
Clamping range (Ø mast)	55-100 mm	100-150 mm	150-190 mm
Clamping range of supporting tube	50 mm	50 mm	50 mm
Length of spacer	1000 mm	1000 mm	1000 mm
Dimensions (w x h x d)	140 x 120 x 55 mm	190 x 140 x 60 mm	230 x 180 x 70 mm
PU	1 pc(s)	1 pc(s)	1 pc(s)

Spacers for omnidirectional antennas with special lengths or any other diameters are available upon request!

4 Accessories for HVI power Conductors / HVI power long Conductors

Note: Please contact us to find out whether the material of the roof conductor holder or base plate is compatible with the roof elements.

Fixing bolt

Fixing bolt for spanning a 50 mm² aluminium cable (Part No. 840 050) to an air-termination rod (Ø22 / Ø16 mm) or a connection plate (e.g. Part No. 819 289 or 819 288).



Part No.	105 229
Hole	1x B 11 mm, 1x B 23 mm
Material of bolt	Al
Wire end ferrule	50 mm ²
Material of wire end ferrule	Cu/Sn
Standard	EN 62561-1
PU	10 pc(s)

Wire end ferrule

Wire end ferrule for securely fixing the aluminium cable with a cross-section of 50 mm² (Part No. 840 050).
1 set = 10 pieces



Part No.	444 050
Material	Cu/Sn
Cross section	50 mm ²
PU	1 set

Roof conductor holder

For flat roofs, weight approx. 4.7 kg.
Conductor holder, concrete block and base plate for installing the HVI power Conductor on flat roofs.



Part No.	253 333
Material of conductor holder	StSt
Conductor support Rd	27 mm
Total weight	approx. 4.7 kg
PU	24 pc(s)

Roof conductor holder

For flat roofs, weight approx. 8.6 kg.
Conductor holder, concrete block and base plate for installing the HVI power Conductor on flat roofs.



Part No.	253 334
Material of conductor holder	StSt
Conductor support Rd	27 mm
Total weight	approx. 8.6 kg
PU	1 pc(s)

Conductor holder

With slotted saddle clamp for HVI power Conductor to be fixed in the concrete block (Part No. 253 301) and base plate (Part No. 253 300).

Part No.	253 330
Material	StSt
Conductor support Rd	27 mm
Height of conductor holder	approx. 87 mm
PU	1 pc(s)



Concrete block

For stabilising the base plate.

Part No.	253 301
Material	concrete (C35/45)
Weight	4.6 kg
Dimensions	180 x 180 x 70 mm
PU	24 pc(s)



Base plate

Base plate to hold the spacer bar (Part Nos. 253 315, 253 325) and conductor holder (Part No. 253 289) and to protect the roof sheeting under the concrete block (Part No. 253 301).

Part No.	253 300
Diameter Ø	300 mm
Diameter Ø of lock bush	10 mm
Height	60 mm
Material	plastic
Colour	grey ●
PU	24 pc(s)



Conductor holder

With slotted saddle clamp for HVI power Conductor for mounting in the concrete block with wedge (Part No. 102 075).

Part No.	253 331
Material	StSt
Conductor support Rd	27 mm
Height of conductor holder	approx. 125 mm
PU	25 pc(s)



Concrete base

With fixing wedge, for air-termination tips Ø10, length 1000 mm or DEHNiso spacers Ø16 mm, length up to 675 mm (distance 0.8 m) or conductor holder (Part No. 253 279).

Part No.	102 075
Total weight	8.5 kg
Diameter Ø	240 mm
Material	concrete (C45/55)
Material of wedge / adapter	StSt
PU	120 pc(s)



Base plate

To protect the roof sheeting under the concrete base. For concrete bases (Part Nos. 102 075, 102 003).

Part No.	102 060
Outside diameter Ø	280 mm
Inside diameter Ø	270 mm
Material	EVA
Colour	black ●
PU	1 pc(s)





Spacer with EB element for HVI power Conductor (length of variable sealing end 350-900 mm)

Spacer for establishing the variable sealing end of the HVI power Conductor.
 With MV clamp for connection to the equipotential bonding (Rd 16 mm / Rd 8-10 mm).
 Concrete base (Part No. 102 010, weight 17 kg) and base plate (Part No. 102 050) must be ordered separately.

Part No.	105 462
Material of spacer	Al
Length of spacer	1270
Conductor support Rd	27 mm
Material of conductor holder	StSt
Clamping range Rd MV clamp	8-10 / 16 mm
Material of clamp	Al
Length of variable sealing end	350-900 mm
Max. gust wind speed (1 base, 17 kg each; l = 900 mm)	100 km/h
Max. gust wind speed (2 bases, 17 kg each; l = 900 mm)	141 km/h
PU	1 pc(s)



Variable tripod with EB element for HVI power Conductor (length of variable sealing end 900-1500 mm)

Tripod (hinged) with variable spacer (small) for establishing the variable sealing end of the HVI power Conductor.
 With UNI earthing clamp for connecting 1x Rd 8-10 mm and 1x conductor 4-50 mm².
 Adjustable to the roof inclination up to max. 10°.
 The three concrete bases (Part No. 102 075, weight 8.5 kg) and base plates (Part No. 102 060) must be ordered separately.

Part No.	105 468
Material of tripod	StSt
Radius	320 mm
Number of concrete bases	3 (8.5 kg each)
Conductor support Rd	27 mm
Adjustment range of spacer	600-1180 mm
Length of variable sealing end	900-1500 mm
Max. gust wind speed (3 bases, 8.5 kg each; l = 900 mm)	170 km/h
Max. gust wind speed (3 bases, 8.5 kg each; l = 1500 mm)	104 km/h
PU	1 pc(s)



Variable tripod with EB element for HVI power Conductor (length of variable sealing end 1500-1800 mm)

Tripod (hinged) with variable spacer (large) for establishing the sealing end of the HVI power Conductor.
 With UNI earthing clamp for connecting 1x Rd 8-10 mm and 1x conductor 4-50 mm².
 Adjustable to the roof inclination up to max. 10°.
 The three concrete bases (Part No. 102 075, weight 8.5 kg) and the base plates (Part No. 102 060) must be ordered separately.

Part No.	105 467
Material of tripod	StSt
Radius	320 mm
Number of concrete bases	3 (8.5 kg each)
Conductor support Rd	27 mm
Adjustment range of spacer	750-1510 mm
Length of variable sealing end	1500-1800 mm
Max. gust wind speed (3 bases, each 8.5 kg; l = 1500 mm)	104 km/h
Max. gust wind speed (3 bases, each 8.5 kg; l = 1800 mm)	93 km/h
PU	1 pc(s)

Spacer for HVI power Conductor

Spacer for additional mechanical fixing in the variable sealing end range.
 The spacer is erected with **two concrete bases** (Part No. 102 010, weight 17 kg). The **concrete bases and base plate** (Part No. 102 050) must be ordered separately.



Part No.	106 814
Material of spacer	GRP
Material of conductor holder / adapter	PA
Number of concrete bases	2 (17 kg each)
Length	1500 mm
Insulating clearance	1475 mm
Conductor support Rd	27 mm
Thread	M8
PU	1 pc(s)

Concrete base

With fixing wedge, stackable, for erecting tripods and air-termination rods Ø16 mm, chamfered or tapered, DEHNiso spacer Ø16 mm or conductor holder (Part No. 253 279).

Part No.	102 010
Weight	17 kg
Support	with fixing wedge Ø16 mm
Diameter Ø	337 mm
Material	concrete (C45/55)
Material of wedge / adapter	StSt
PU	54 pc(s)



Base plate

To protect the roof sheeting under the concrete base. For concrete bases (Part Nos. 102 010, 102 002).

Part No.	102 050
Outside diameter Ø	370 mm
Inside diameter Ø	360 mm
Material	EVA
Colour	black ●
PU	1 pc(s)



Conductor holder

With thread. For wall mounting with two-screw conductor clamp (not for use in the sealing end range).

Part No.	275 240	275 241
Material of conductor holder	StSt	StSt
Conductor support Rd	27 mm	27 mm
Thread	M8	M6
PU	25 pc(s)	25 pc(s)



Conductor holder

With plastic base.

For wall mounting, with two-screw conductor clamp (not for use in the sealing end range).

Part No.	275 249
Material of conductor holder	StSt
Conductor support Rd	27 mm
Thread	M8
PU	25 pc(s)



Conductor holder

With slot hole. For wall mounting, with two-screw conductor clamp (not for use in the sealing end range).

Part No.	275 242
Material of conductor holder	StSt
Conductor support Rd	27 mm
Fixing hole	5.5 x 10 mm
PU	25 pc(s)



Conductor holder with tensioning strap

For fixing the HVI power Conductor, e.g. to pipes.

Part No.	275 339
Material of conductor holder	StSt
Conductor support Rd	27 mm
Tensioning range Ø pipe	50-300 mm
PU	1 pc(s)



Conductor holder for for fixing with a tensioning strap

For fixing the HVI power Conductor at pipes e.g. with pipe clamp (Part No. 106 323).

Part No.	275 359
Material of conductor holder	StSt
Conductor support Rd	27 mm
PU	1 pc(s)



Pipe clamp

For fixing (clamping) conductor holders (e.g. Part No. 275 319).



Part No.	106 323
Material of head / strap	StSt
Clamping range Ø	50-300 mm
Dimensions of strap	1100 x 25 x 0.3 mm
Material of screw	StSt
PU	10 pc(s)

Separate grip head

For combination with endless tensioning strap (Part No. 540 901) in case of larger pipe diameters.



Part No.	106 324
Material of head	StSt
For strap (w x d)	25 x 0.3 mm
Screw	M8 x 20 mm
Material of screw	StSt
PU	20 pc(s)

Tensioning strap



Part No.	540 901
Material	StSt
Strap dimensions (w x d)	25 x 0.3 mm
Length	100 m
Military Name	VG 96953 T05 BB001
PU	1 pc(s)

Roof conductor holder

With pre-punched points for bending and hooking into the roof tile and for screwing onto battens to install the HVI power Conductor on gable roofs.



Part No.	202 857
Material of roof conductor holder	StSt
Material of conductor holder	StSt
Conductor support Rd	27 mm
Length of brace	205 mm
PU	1 pc(s)

Roof conductor holder for roofs with round standing seam

Roof conductor holder with slotted saddle clamp for fixing the HVI power Conductor onto metal roofs with round standing seam.



Part No.	202 860
Material of roof conductor holder	StSt
Material of conductor holder	StSt
Clamping range	Ø20-25 mm
Conductor support Rd	27 mm
Standard	EN 62561-4
PU	25 pc(s)

Roof conductor holder for roofs with clamping seam (e.g. RIB-ROOF Speed 500 from Zambelli)

Roof conductor holder with slotted saddle clamp for fixing the HVI power Conductor onto metal roofs with clamping seam.



Part No.	202 861
Material of roof conductor holder	StSt
Material of conductor holder	StSt
Clamping range	approx. 18 / 22 mm
Conductor support Rd	27 mm
Standard	EN 62561-4
PU	25 pc(s)

Roof conductor holder for roofs with standing seam

Roof conductor holder with saddle slotted clamp for fixing the HVI power Conductor onto metal roofs with standing seam.

Part No.	202 862
Material of roof conductor holder	StSt
Material of conductor holder	StSt
Clamping range	0.7-8 mm
Conductor support Rd	27 mm
Standard	EN 62561-4
PU	25 pc(s)



Roof conductor holder with connection lug

Roof conductor holder with slotted saddle clamp for HVI power Conductor and Z-shaped connection lug for riveting or screwing to metal roofs.

Part No.	202 863
Material of roof conductor holder	StSt
Material of conductor holder	StSt
Fixing	[4x] Ø5.2 / [2x] Ø6.5 mm
Conductor support Rd	27 mm
Standard	EN 62561-4
PU	25 pc(s)



Conductor Holders for HVI power Conductors in Ex Areas

The HVI power Conductor is suitable for installation in explosion hazardous areas Ex zone 1 (gases, vapours, mists) as well as Ex zone 21 (dust). The special installation conditions safely prevent electric sparks to neighbouring metal parts when lightning current flows through the HVI power Conductor.

The HVI power Conductor has to be installed in accordance with the installation instructions.



HVI power Ex W85 holder

For fixing on metal structural parts (facades) in Ex zones 1 and 21.

Part No.	275 450
Material	StSt
Conductor support Rd	27 mm
Distance from wall	85 mm
Fixing	[4x] Ø5.1 / [2x] 7 x 10 mm
PU	10 pc(s)



HVI power Ex W240 holder

For fixing on metal structural parts (facades) in Ex zones 1 and 21.

Part No.	275 451
Material	StSt
Conductor support Rd	27 mm
Distance from wall	240 mm
Fixing	[4x] Ø5.1 / [2x] 7 x 10 mm
PU	10 pc(s)



HVI power Ex busbar 500

For installing the HVI power Conductor with conductor holders HVI Ex W85 holder (Part No. 275 450) on a non-conductive structure, e.g. stone, wood.

Part No.	275 498
Fixing	[4x] Ø5.5 / [2x] 7 x 10 mm
PU	10 pc(s)



HVI power Ex P85 holder

For fixing to pipes, e.g. with pipe clamp (Part No. 106 323) in Ex zones 1 and 21.



Part No.	275 454
Material	StSt
Conductor support Rd	27 mm
Distance from wall	95 mm
Clamping range of tube	50-300 mm
PU	10 pc(s)

HVI power Ex P240 holder

For fixing to pipes, e.g. with pipe clamp (Part No. 106 323) in Ex zones 1 and 21.



Part No.	275 455
Material	StSt
Conductor support Rd	27 mm
Distance from wall	250 mm
Clamping range of tube	50-300 mm
PU	10 pc(s)

Accessories for Conductor Holders for HVI power Conductors in Ex Areas

Pipe clamp

For fixing (clamping) conductor holders (e.g. Part No. 275 319).



Part No.	106 323
Material of head / strap	StSt
Clamping range Ø	50-300 mm
Dimensions of strap	1100 x 25 x 0.3 mm
Material of screw	StSt
PU	10 pc(s)

Separate grip head

For combination with endless tensioning strap (Part No. 540 901) in case of larger pipe diameters.



Part No.	106 324
Material of head	StSt
For strap (w x d)	25 x 0.3 mm
Screw	☒ M8 x 20 mm
Material of screw	StSt
PU	20 pc(s)

Tensioning strap



Part No.	540 901
Material	StSt
Strap dimensions (w x d)	25 x 0.3 mm
Length	100 m
Military Name	VG 96953 T05 BB001
PU	1 pc(s)

4 Connecting Components 200 kA (10/350 μs)

For use in class of LPS I and II (LPL I, II).
Clamps are tested with a 200 kA (10/350 μs) lightning impulse current, based on EN 62561-1.



UNI disconnecting clamp for two round conductors

Part No.	459 200
Material	StSt
Clamping range Rd / Rd	10 / 10 mm
Clamping range Rd / Fl	10 / 30 mm
Lightning current carrying capability (10/350 μs)	200 kA
Standard	based on EN 62561-1
PU	1 pc(s)



UNI disconnecting clamp for earth entry rods

Part No.	459 219
Material	StSt
Clamping range Rd / Rd	8-10 / 16 mm
Lightning current carrying capability (10/350 μs)	200 kA
Standard	based on EN 62561-1
PU	1 pc(s)



Clamping piece

Part No.	380 209
Material	StSt
Clamping range Fl	30 x 4 mm
Lightning current carrying capability (10/350 μs)	200 kA
Standard	based on EN 62561-1
PU	1 pc(s)



KS connector

Part No.	301 209
Material	StSt
Clamping range Rd	10 mm
Lightning current carrying capability (10/350 μs)	200 kA
Standard	based on EN 62561-1
PU	1 pc(s)



MV clamp for round conductors

Part No.	390 209
Material	StSt
Clamping range Rd / Rd	8-10 mm
Lightning current carrying capability (10/350 μs)	200 kA
Standard	based on EN 62561-1
PU	1 pc(s)



MV clamp for air-termination rods

Part No.	392 209
Material	StSt
Clamping range Rd / Rd	8-10 / 16 mm
Lightning current carrying capability (10/350 μs)	200 kA
Standard	based on EN 62561-1
PU	1 pc(s)



HVI power Conductor

4 Stripping Tool for HVI power Conductors



Tool for stripping the semi-conductive sheath and the PE insulation of the HVI power Conductor (outer diameter 27 mm)

- Tool consists of a handle and various exchangeable cutting heads
- Stripping length of the HVI power Conductor is adjustable in steps of 0.2 mm (lock points) using the knob in the handle. The dial on the handle shows the length set.

Handling

Position the cutting head at the cut-off end of the conductor and turn clockwise with light pressure to cut/strip it. The cutting head can be exchanged without tools via the bayonet coupling.

HVI strip 27

For HVI power Conductors.



Part No.	597 227
Diameter Ø conductor	27 mm
Material of moulded part	plastic / Al
Material of blade	StSt
PU	1 pc(s)

HVI head 27

For HVI power Conductors.



Part No.	597 127
Diameter Ø conductor	27 mm
Material of moulded part	Al
Material of blade	StSt
PU	1 pc(s)

HVI power Conductor

Accessories for Stripping Tool for HVI power Conductors

HVI head holder

Adapter with bayonet coupling for attaching the HVI head cutting head (pre-set stripping length 35 mm). Adapter can be used in a standard three-jaw chuck (Ø10 mm), e.g. with cordless screwdrivers.



Part No.	597 139
Material	plastic / brass
PU	1 pc(s)

Spare blades for HVI head 27

1 set = 4 blades



Part No.	597 102
Material	StSt
PU	1 set

4 Cable shears for HVI Conductors



Cable shears for easily cutting the HVI light Conductor, HVI Conductor (outer diameter 20 / 23 mm), HVI power Conductor (outer diameter 27 mm) and CUI Conductor to length.

The special design of the cable shears also allows precise cutting of stranded conductors, making it easier to attach connection elements.

HVI cutter



Part No.	597 032
Diameter Ø conductor	up to 32 mm
Material of blades	tool steel (CR-Moly (SCM440))
Material of handles	carbon steel (SS400)
Length	600 mm
PU	1 pc(s)

5 Sealing End Range, Connection to "Isolated Ring Conductor"

If several installation parts require protection, it is advisable not to route the HVI power Conductor of each air-termination system individually to the earth-termination system. The HVI power Conductors from the air-termination system can be connected to an "isolated ring conductor". From this "isolated ring conductor" several down conductors can then be led to the earth-termination system. The "isolated ring conductor" must be installed, e.g. on the roof, on spacers and concrete bases, taking the calculated separation distance "s" into account.

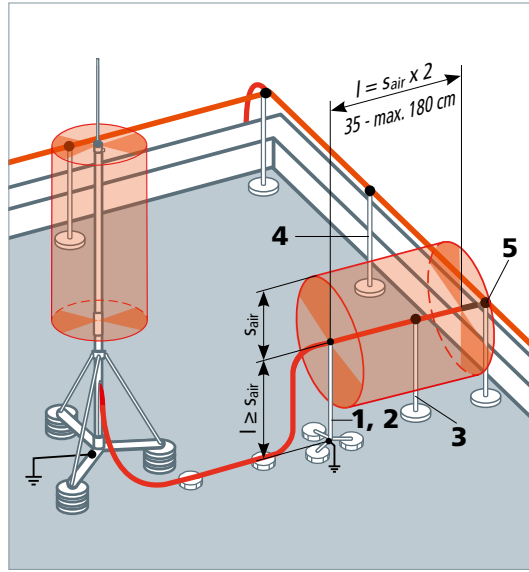
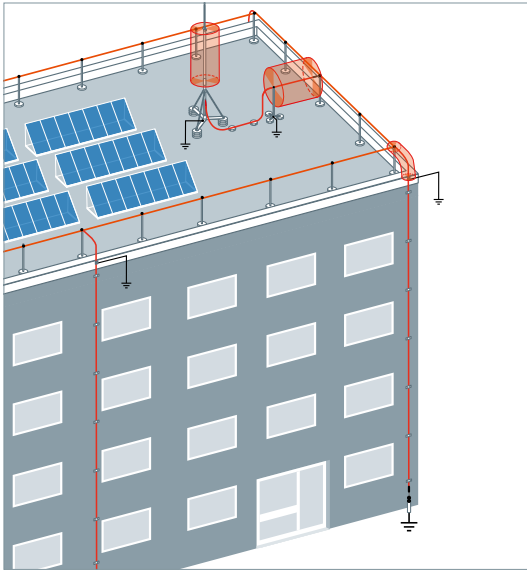

HVI power Conductor

Accessories for the Sealing End Range, Connection to "Isolated Ring Conductor"

Spacer with EB element for HVI power Conductor (length of variable sealing end 350-900 mm)

Spacer for establishing the variable sealing end of the HVI power Conductor. With MV clamp for connection to the equipotential bonding (Rd 16 mm / Rd 8-10 mm). Concrete base (Part No. 102 010, weight 17 kg) and base plate (Part No. 102 050) must be ordered separately.

Part No.	105 462
PU	1 pc(s)

Variable tripod with EB element for HVI power Conductor (length of variable sealing end 900-1800 mm)

Tripod (hinged) with variable spacer (small) for establishing the variable sealing end of the HVI power Conductor. For a variable sealing end length of 900-1500 mm (Part No. 105 468) and 1500-1800 mm (Part No. 105 467). With UNI earthing clamp for connecting 1x Rd 8-10 mm and 1x conductor 4-50 mm². Adjustable to the roof inclination up to max. 10°. The **three concrete bases** (Part No. 102 075, weight 8.5 kg) and **base plates** (Part No. 102 060) must be ordered separately.

Part No.	105 468	105 467
PU	1 pc(s)	1 pc(s)

Spacer for HVI power Conductor

Spacer for additional mechanical fixing in the variable sealing end range. The spacer is erected with **two concrete bases** (Part No. 102 010, weight 17 kg). The **concrete bases** and **base plate** (Part No.Nr. 102 050) must be ordered separately.

Part No.	106 814
PU	1 pc(s)

DEHNiso spacer

For, e.g. air-termination tip (Part No. 101 001), air-termination tip with MV clamp (Part No. 105 071) (for crossover points) or MV clamp for spanning cables (Part No. 105 079).

Part No.	106 217	106 220
PU	10 pc(s)	10 pc(s)

MV clamp

With hexagon screw, spring washer and thread in the base part. Lightning current carrying capability 200 kA (10/350 µs).

Part No.	390 209
PU	1 pc(s)



5 Sealing End Range, Connection to "Capping of Roof Parapet"

If several installation parts require protection, it is advisable not to route the HVI power Conductor of each air-termination system individually to the earth-termination system. The HVI power Conductors from the air-termination system can be connected to the capping of the roof parapet which serves as a ring conductor. From the capping of the roof parapet several down conductors can then be led to the earth-termination system.

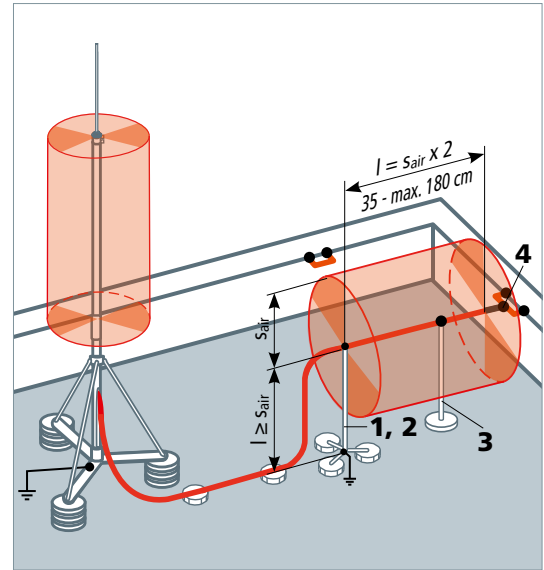
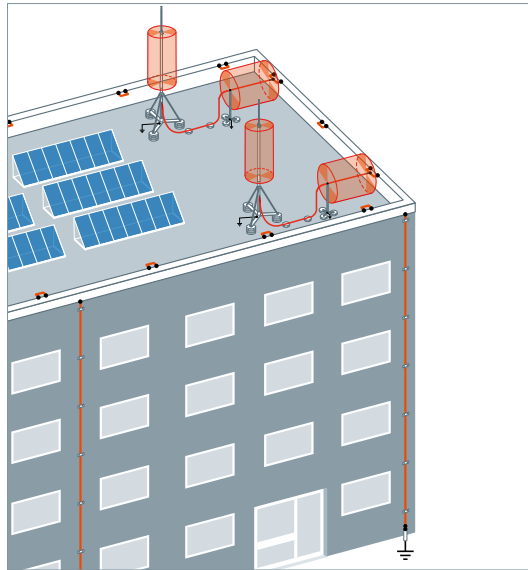

HVI power Conductor

Accessories for the Sealing End Range, Connection to "Capping of Roof Parapet"



1 Spacer with EB element for HVI power Conductor (length of variable sealing end 350-900 mm)

Spacer for establishing the variable sealing end of the HVI power Conductor. With MV clamp for connection to the equipotential bonding (Rd 16 mm / Rd 8-10 mm). Concrete base (Part No. 102 010, weight 17 kg) and base plate (Part No. 102 050) must be ordered separately.

Part No.	105 462	
PU	1 pc(s)	



2 Variable tripod with EB element for HVI power Conductor (length of variable sealing end 900-1800 mm)

Tripod (hinged) with variable spacer for establishing the variable sealing end of the HVI power Conductor. For a variable sealing end length of 900-1500 mm (Part No. 105 468) and 1500-1800 mm (Part No. 105 467). With UNI earthing clamp for connecting 1x Rd 8-10 mm and 1x conductor 4-50 mm². Adjustable to the roof inclination up to max. 10°. The three concrete bases (Part No. 102 075, weight 8.5 kg) and base plates (Part No. 102 060) must be ordered separately.

Part No.	105 468	105 467
PU	1 pc(s)	1 pc(s)



3 Spacer for HVI power Conductor

Spacer for additional mechanical fixing in the variable sealing end range. The spacer is erected with two concrete bases (Part No. 102 010, weight 17 kg). The concrete bases and base plate (Part No. 102 050) must be ordered separately.

Part No.	106 814	
PU	1 pc(s)	



4 KS connector

With M10 screw and nut. Lightning current carrying capability 200 kA (10/350 μs).

Part No.	301 209	
PU	1 pc(s)	

5 Sealing End Range on a Building

If HVI power Conductors are installed on a building, the calculated separation distance "s" in the sealing end range from metal parts on the building must be maintained. The sealing end range extends from the EB connection element to the earth-termination connection element. If the HVI power Conductor is directly connected with an earth entry rod / earth-termination system, an EB element is not necessary. The sealing end range thus also remains unconsidered.

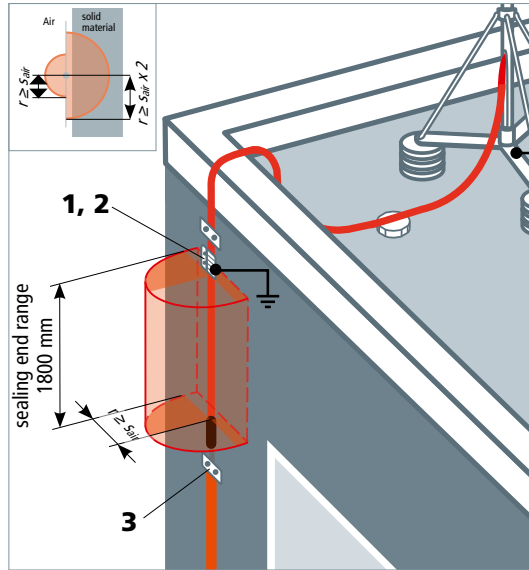
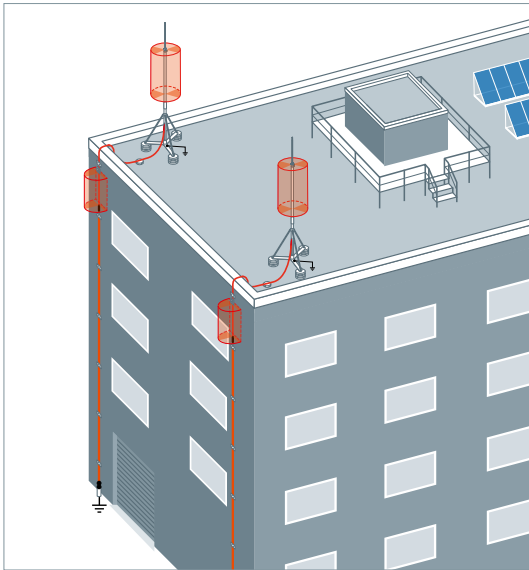

HVI power Conductor

Accessories for the Sealing End Range on a Building

EB Connection element for HVI power / HVI power long Conductor

EB connection element for discharging the electric field of the HVI power Conductor (pre-assembled / on a reel) in the sealing end range. Special slotted design to electrically contact the semi-conductive sheath.

Part No.	410 239
PU	1 pc(s)



KS connector

With screw and nut M10.

Part No.	301 019
PU	100 pc(s)



Disconnecting clamp

Disconnecting clamp with spring washer for connecting the HVI power Conductor with the earth entry rod. Lightning current carrying capability 200 kA (10/350 μs).

Part No.	459 200
PU	1 pc(s)

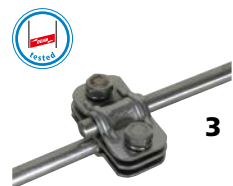

Protection against Step and Touch Voltage

IEC/EN 62305-3 points out that in special cases the risk of step and touch voltage outside a building may be extremely high near the down conductors, although there is a lightning protection system in accordance with the current state of standardisation.

Special cases are, for example, if bare/uninsulated down conductors and lightning protection earth electrodes are installed near the entrance or sheltering areas of buildings with high visitor frequency, such as theatres, cinemas, shopping centres, etc. Buildings or structures with public access (e.g. shelters) which are particularly exposed (lightning endangered) may also require protection measures against step and touch voltage.

Protection against touch voltage

Touch voltage means a life-threatening voltage that affects a person who touches the down conductor while standing on the ground within a distance of about 1 m from the down conductor. The current flows through the hand into the body and down to the feet (see **Figures 1/2**).

The hazardous area for people outside of the building is defined as an area of 3 m around the down conductor and from ground level up to a height of approx. 3 m.

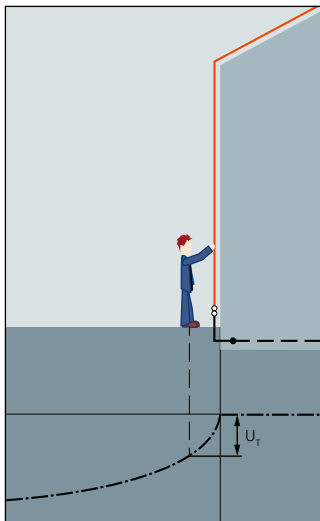

Figure 1: Schematic diagram – touch voltage U_T

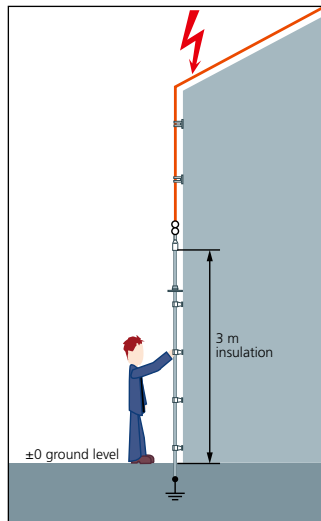

Figure 2: Protective measures

Effective protection measures against injuries due to touch voltage are defined according to the standard:

- Installation of an insulated (coated) down conductor providing a surge withstand capability of 100 kV at 1.2/50 μ s, e.g. at least 3 mm thick cross-linked polyethylene;
- physical restrictions and/or warning signs to minimise the possibility of down conductors being touched.

The CUI conductor (**CU** copper Insulated) has an inner copper conductor with a diameter of 8 mm and a high-voltage-resistant insulation.

Requirements:

- Surge withstand capability of 100 kV (1.2/50 μ s)
- Prevention of creepage sparkover even during rain.

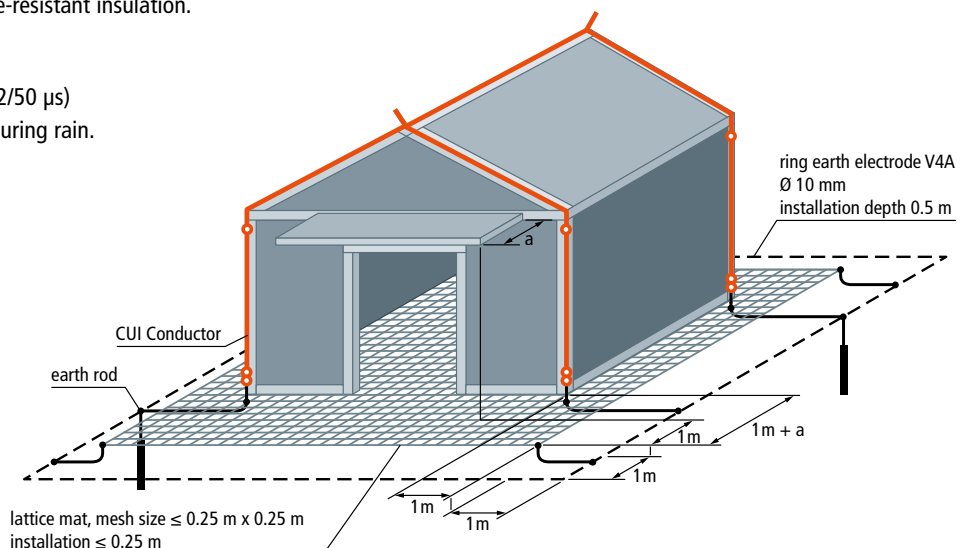

The surge withstand capability of 100 kV (1.2/50 μ s) is achieved by a special cross-linked polyethylene insulation (XLPE). Unless additional measures are taken, high impulse voltages cause sparkover on insulating surfaces. This effect is known as creeping discharge. If the creeping discharge inception voltage is exceeded, a surface discharge will be initiated, which can easily spark over a distance of several metres to earthed parts. In order to avoid the occurrence of creeping discharges even during rain, the CUI conductor additionally has a shield which keeps the conductor dry. **Figure 4** shows this shield on the conductor and the drops after the rain test.



Figure 4: Rain test

Application in the entrance area



Development of the CUI conductor is based on the "rain test" according to IEC 60-1 Subclause 9 (see **Figure 4**).

Protection against step voltage

IEC/EN 62305-3 not only mentions the risk of touch voltage, but also the risk of step voltage. The risk for living beings can be reduced by protective measures. In addition to increasing the earth resistivity of the upper ground layer (ground insulation, e.g. asphalt), potential control can also be achieved by installing a close metal grid (mesh mat) in the foundation/ground in areas where people stand (max. mesh size 0.25 m x 0.25 m). In addition, a ring earth electrode should be laid 1.0 m away from the mats at a depth of 0.5 m. Lattice mats should be installed at least 1.0 m beyond the area to be protected (e.g. building boundary). If the enclosed area of the ring earth electrode is $\leq 78.5 \text{ m}^2$, at least two earth rods, should be installed. If the area is $>78.5 \text{ m}^2$ one earth rod each per down conductor is required (9 m proved to be advantageous). An earth resistance of less than 10 Ω is recommended. The described protection measure is based on a maximum earth resistivity of 2000 Ω m.

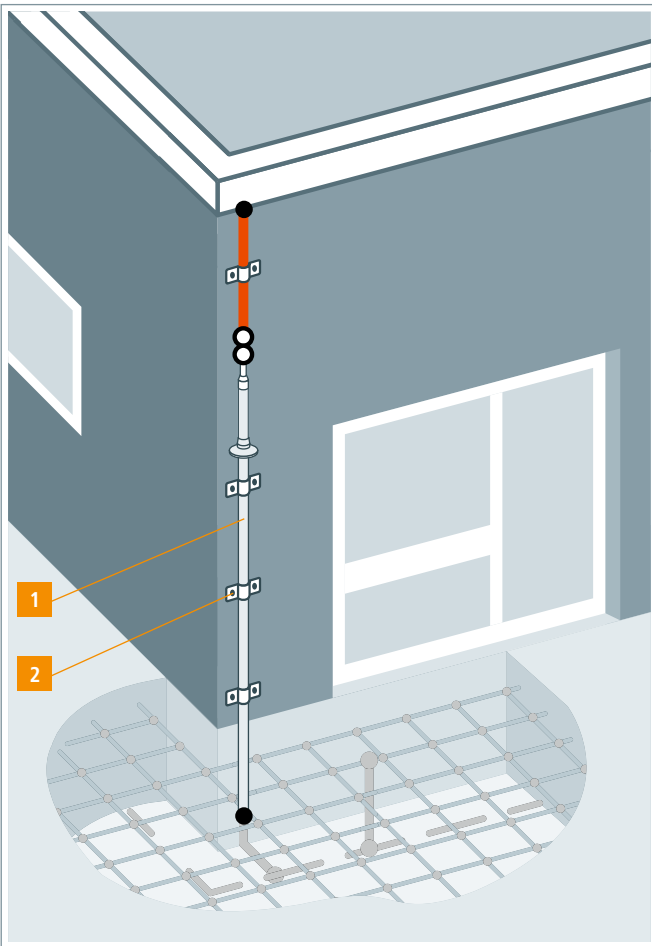

Protection against touch voltage

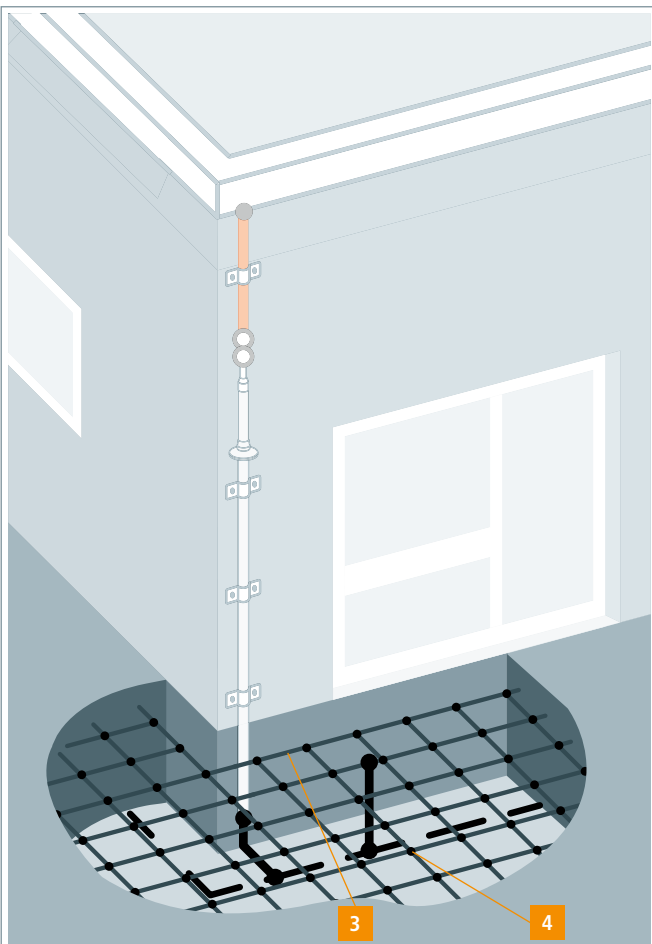

Product	Product name
1 	CUI Conductor see Page 218
2 	Conductor Holders Stripping Tool see Page 218

Protection against step voltage

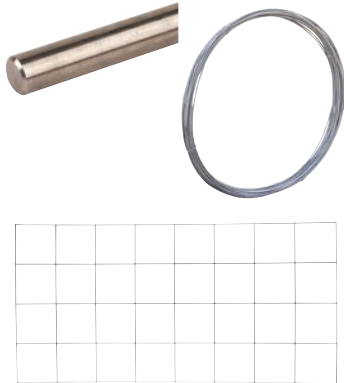

Product	Product name
3 	Round Wires Connection Lugs Mesh Mats see Page 220
4 	Clamps Connectors Conductor Holders see Page 220

1 CUI Conductor

Touch voltage on down conductors can be prevented by using the CUI Conductor.

The dangerous area of touch and step voltages for living beings is defined as an area of approx. 3 m around the down conductor, from ground level up to a height of approx. 3 m.

The CUI Conductor has a copper core and a high-voltage-resistant insulation.

These conductors must:

- have a impulse withstand voltage of 100 kV (1.2/50 μ s)
- prevent creeping sparkover even during rain

Part No.	830 208	830 218
Material of conductor	Cu	Cu
Material of insulation	XLPE	XLPE
Diameter \varnothing conductor	20 mm	20 mm
Standard	EN 62561-2	EN 62561-2
Colour of conductor	light grey ●	light grey ●
Cross-section of core	50 mm ²	50 mm ²
Total length	3500 mm	5000 mm
PU	1 pc(s)	1 pc(s)

2 Conductor Holders for CUI Conductor

For installing the CUI Conductor on walls or façades.

Height 19 mm

Part No.	275 220
Material of conductor holder	PA
Conductor support Rd	20 mm
Fixing	\varnothing 6.5 mm
PU	25 pc(s)

Height 10 mm

Part No.	275 229
Material of conductor holder	StSt
Conductor support Rd	20 mm
Fixing	6.5 x 16 mm
Standard	EN 62561-4
PU	50 pc(s)

Two-screw clamp for mounting directly on the wall

Due to the special kind of installation (without a gap), the conductor cannot be misused as a climbing aid and is therefore especially suitable for schools or kindergarten facilities.



Part No.	275 129
Material of conductor holder	StSt
Conductor support Rd	20 mm
Fixing	[2x] 6.5 x 8 mm
PU	10 pc(s)

2 Stripping Tool for CUI Conductors



Tool for stripping the XLPE insulated CUI Conductor (outer diameter 20 mm).

- Tool consists of a handle and an exchangeable cutting heads
- Stripping length of the CUI Conductor is adjustable in steps of 0.2 mm (lock points) using the knob in the handle. The dial on the handle shows the length set.

Handling

Position the cutting head at the cut-off end of the conductor and turn clockwise with light pressure to cut / strip it.

CUI-strip 20

Part No.	597 320
Diameter Ø conductor	20 mm
Material of moulded part	plastic
Material of blade	StSt
PU	1 pc(s)



CUI-head 20

Toolless exchange of the cutting head via a bayonet coupling.

Part No.	597 020
Diameter Ø conductor	20 mm
Material of moulded part	plastic
Material of blade	StSt
PU	1 pc(s)



More details can be found in installation instructions No. 1845.

Sign

Sign warning of the hazard of direct lightning strikes, e.g. on park decks (without air-termination systems) or other areas.

Lightning voltage

Front in German

"ACHTUNG! Blitzspannung

Bei Gewitter Bereich räumen / nicht betreten"

Reverse side in English

"ATTENTION! Lightning voltage

Clear / do not enter this area during thunderstorms"

Part No.	480 698
Material	Al
Dimensions (l x w x d)	297 x 210 x 0.7 mm
Fixing	[4x] Ø6.5 mm
PU	1 pc(s)



Sign

In case of step and touch voltage hazard for living beings. In accordance with the requirements of IEC/EN 62305-3.

Step and touch voltage

Front in German:

Bei Gewitter ist der Aufenthalt im Umkreis von 3 m um die Ableitung verboten!

Reverse side in English:

During thunderstorm a distance of 3 m around the down conductor has to be kept!

Part No.	480 699
Material	Al
Dimensions (l x w x d)	297 x 210 x 0.7 mm
Fixing	[4x] Ø6.5 mm
PU	1 pc(s)



3 4 Potential Grading



Mesh mats for potential grading in shelters and entrance areas.

Mesh mat for protection against step voltage

According to VDE/ABB leaflet "Lightning Protection of Shelters" (VDE/ABB Merkblatt "Blitzschutz von Schutzhütten")



Part No.	618 214
Material	StSt (V4A)
Material No.	1.4571 / 1.4404 / 1.4401
ASTM / AISI:	316Ti / 316L / 316
Dimensions (l x w x d)	2000 x 1000 x 4 mm
Mesh size	250 mm
PU	1 pc(s)

Connecting clamp for mesh mats

Clamp for interconnecting mesh mats or for connecting mesh mats with earth-termination systems.



Part No.	540 271
Material	StSt (V4A)
Material No.	1.4571 / 1.4404 / 1.4401
ASTM / AISI:	316Ti / 316L / 316
Clamping range Rd / Rd	8-10 / 3-5 mm
Clamping range Rd / Rd	3-5 / 3-5 mm
Lightning impulse current carrying capability (10/350 µs)	25 kA
Standard	based on EN 62561-1
PU	50 pc(s)

Accessories for Potential Grading

Stainless steel wire

Stainless steel wire (Rd 10 mm) for use in soil has to be made of StSt (V4A) with a molybdenum content of > 2 %, e.g. 1.457, according to EN 62561-2, IEC/EN 62305-3, DIN 18014 and DIN VDE 0151.



Part No.	860 010	860 020	860 050
Diameter Ø conductor	10 mm	10 mm	10 mm
Cross-section	78 mm ²	78 mm ²	78 mm ²
Material	StSt (V4A)	StSt (V4A)	StSt (V4A)
Material No.	1.4571 / 1.4404	1.4571 / 1.4404	1.4571 / 1.4404
Standard	EN 62561-2	EN 62561-2	EN 62561-2
Short-circuit current (50 Hz) (1 s; ≤ 300 °C)	2.9 kA	2.9 kA	2.9 kA
Conductor length	80 m	20 m	50 m
Coil weight	approx. 50 kg	approx. 12 kg	approx. 31 kg
PU	80 m	20 m	50 m

Connection lug, straightened

For connecting the down conductors to the earth-termination system; made of corrosion-resistant stainless steel StSt (V4A).



Part No.	860 110	860 115	860 130
Material	StSt (V4A)	StSt (V4A)	StSt (V4A)
Material No.	1.4571 / 1.4404	1.4571 / 1.4404	1.4571 / 1.4404
Length	1000 mm	1500 mm	3000 mm
Dimensions	Ø10 mm	Ø10 mm	Ø10 mm
Cross-section	78 mm ²	78 mm ²	78 mm ²
Standard	EN 62561-2	EN 62561-2	EN 62561-2
PU	5 pc(s)	5 pc(s)	5 pc(s)

MV clamp

Multipurpose connecting clamp (Mehrzweck Verbindungs-Klemme) for universal use as a cross, T and parallel clamp; two-piece.

Part No.	390 079
Material of clamp	StSt (V4A)
Material No.	1.4571 / 1.4404
Clamping range Rd	8-10 mm
Standard	EN 62561-1
Short-circuit current (50 Hz) (1 s; ≤ 300 °C)	4.7 kA
PU	50 pc(s)



SV clamp

Diagonal connecting clamp (Schräg-Verbinder-Klemme) for cross and T connections, screws with anti-rotation protection.

Part No.	308 329
Material of clamp	StSt (V4A)
Material No.	1.4571 / 1.4404 / 1.4401
Clamping range Rd / Rd	7-10 / 7-10 mm
Clamping range Rd / Fl	7-10 / 30-40 mm
Clamping range Fl / Fl	30-40 / 30-40 mm
Standard	EN 62561-1
Short-circuit current (50 Hz) (1 s; ≤ 300 °C)	14.0 kA
PU	25 pc(s)



UNI disconnecting clamp

For connecting the down conductors with the earth entry rods.

Part No.	459 129
Material	StSt
Clamping range Rd / Rd	8-10 / 8-10 mm
Distance of screws	40 mm
Standard	EN 62561-1
PU	50 pc(s)



Conductor holder DEHNhold

Conductor holder for fixing round conductors with slotted saddle clamp, fixed conductor routing.

Part No.	274 160
Material of conductor holder	StSt
Conductor support Rd	8-10 mm
Conductor support Fl	20 mm
Height of conductor holder	20 mm
Thread of conductor holder	M8
Screw	⚡ 5 x 50 mm
Standard	EN 62561-4
PU	50 pc(s)



Anti-corrosion tapes

For wrapping aboveground and underground connections.
For use in soil according to DIN 30672. Reels, length 10 m, UV-stabilised.

Part No.	556 125	556 130
Material	petrolatum	petrolatum
Width of tape	50 mm	100 mm
PU	24 pc(s)	12 pc(s)





DEHN protects.

Protective equipotential bonding via main earthing busbar

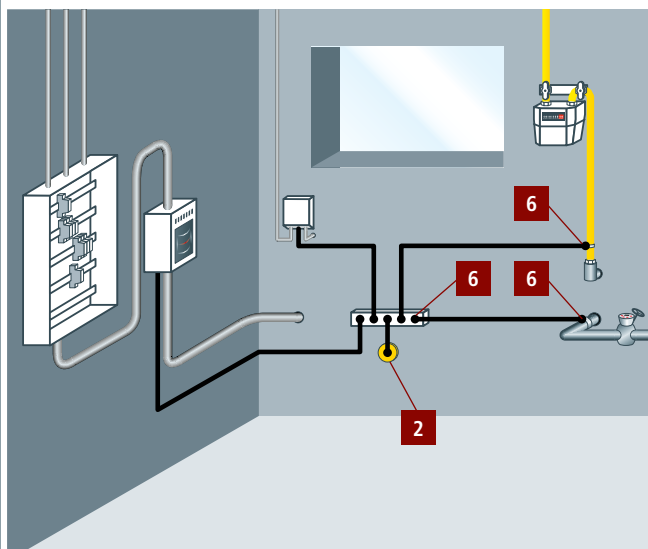

Protective equipotential bonding in a transformer room

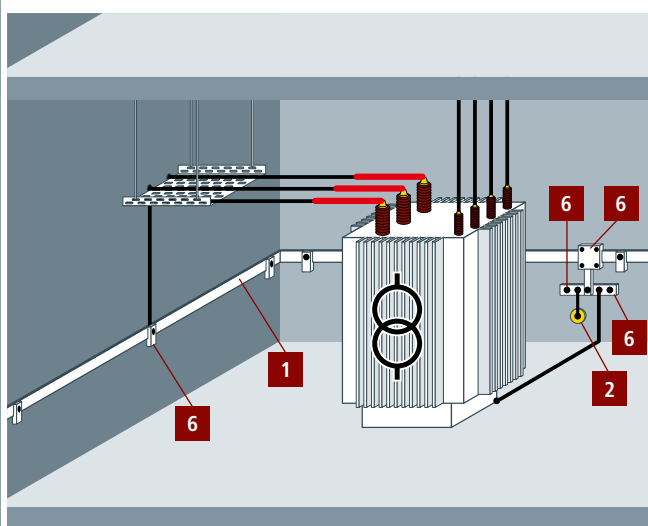

Equipotential bonding in Ex areas

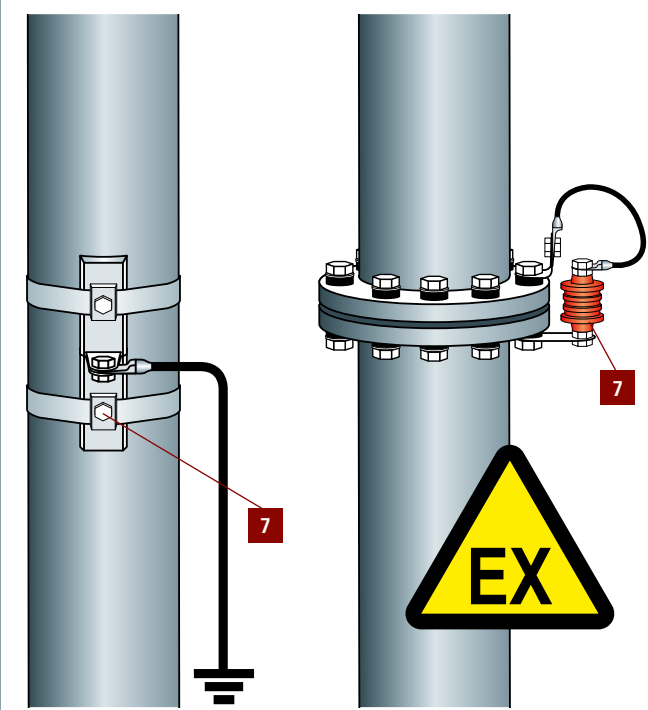

Product	Product name
<p>1</p>	<p>Round Wires Strips Cables see Page 225</p>
<p>2</p>	<p>Fixed Earthing Terminals Wall Bushings see Page 233</p>
<p>3</p>	<p>Clamps Connectors see Page 239</p>
<p>4</p>	<p>Hammer Inserts Earth Rods Connection Brackets Connection Clamps see Page 245</p>
<p>5</p>	<p>Earthing Cables Earthing Cable Lugs Earthing Clamps Earthing Spikes see Page 255</p>
<p>6</p>	<p>Equipotential Bonding Bars Earthing Pipe Clamps Earthing Tong see Page 265</p>
<p>7</p>	<p>Pipe Clamps Clamps Spark Gaps see Page 279</p>
<p>8</p>	<p>Measuring Devices Wire Straighteners Straightening Tools see Page 289</p>

Earthing / Equipotential Bonding

Product name	Product
Round Wires Strips Cables see Page 225	1 
Fixed Earthing Terminals Wall Bushings see Page 233	2 
Clamps Connectors see Page 239	3 
Hammer Inserts Earth Rods Connection Brackets Connection Clamps see Page 245	4 
Earthing Cables Earthing Cable Lugs Earthing Clamps Earthing Spikes see Page 255	5 
Equipotential Bonding Bars Earthing Pipe Clamps Earthing Tongues see Page 265	6 
Pipe Clamps Clamps Spark Gaps see Page 279	7 
Measuring Devices Wire Straighteners Straightening Tools see Page 289	8 

Foundation earth electrode in accordance with DIN 18014 with lightning protection system. Insulated reinforced floor slab as black or white tank (waterproof concrete) with full perimeter insulation, dimpled membrane

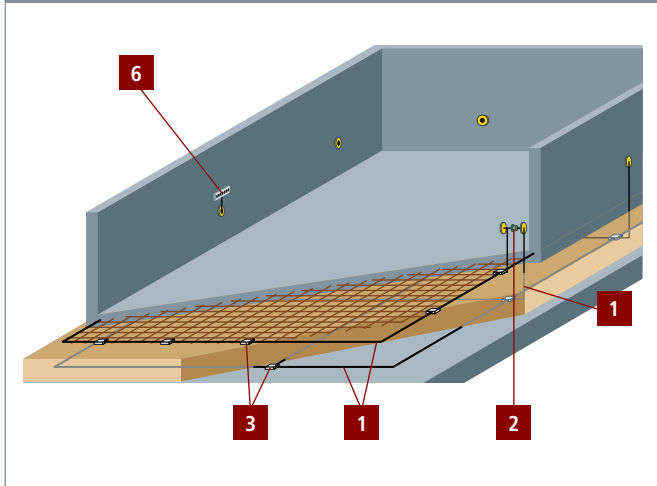

Foundation earth electrode in accordance with DIN 18014 without lightning protection system; reinforced floor slab, not waterproof concrete

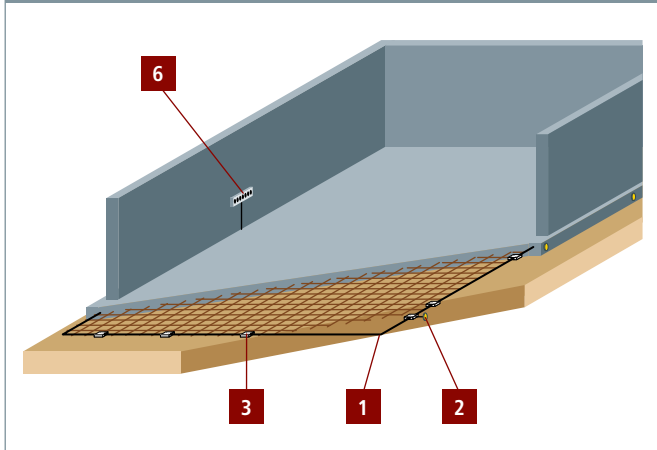

Round Wires

According to EN 62561-2, for use in lightning protection and earth-termination systems.

Stainless steel wire

Stainless steel wires (Rd 10 mm) for use in soil have to be made of StSt (V4A) with a molybdenum content > 2 %, e.g. 1.4571 or 1.4404, in accordance with EN 62561-2, IEC/EN 62305-3, DIN 18014 and DIN VDE 0151.

General technical data:				
Standard	based on EN 62561-2			
Part No.	860 908	860 920	860 950	860 910
Diameter Ø conductor	8 mm	10 mm	10 mm	10 mm
Cross-section	50 mm ²	78 mm ²	78 mm ²	78 mm ²
Material	StSt	StSt	StSt	StSt
Material No.	1.4301 / 1.4303	1.4301 / 1.4303	1.4301 / 1.4303	1.4301 / 1.4303
Short-circuit current (50 Hz) (1 s; ≤ 300 °C)	—	—	—	—
Coil weight	approx. 50 kg	approx. 12 kg	approx. 31 kg	approx. 50 kg
PU	125 m	20 m	50 m	80 m
Part No.	860 008	860 010	860 020	860 050
Diameter Ø conductor	8 mm	10 mm	10 mm	10 mm
Cross-section	50 mm ²	78 mm ²	78 mm ²	78 mm ²
Material	StSt (V4A)	StSt (V4A)	StSt (V4A)	StSt (V4A)
Material No.	1.4571 / 1.4404	1.4571 / 1.4404	1.4571 / 1.4404	1.4571 / 1.4404
Short-circuit current (50 Hz) (1 s; ≤ 300 °C)	—	2.9 kA	2.9 kA	2.9 kA
Coil weight	approx. 50 kg	approx. 50 kg	approx. 12 kg	approx. 31 kg
PU	125 m	80 m	20 m	50 m



Steel wire

With zinc coating ≥ 50 µm on average (approx. 350 g/m²).

Part No.	800 008	800 010	800 310
Diameter Ø conductor	8 mm	10 mm	10 mm
Cross-section	50 mm ²	78 mm ²	78 mm ²
Material	St/tZn	St/tZn	St/tZn
Standard	based on EN 62561-2	based on EN 62561-2	based on EN 62561-2
Short-circuit current (50 Hz) (1 s; ≤ 300 °C)	—	5.5 kA	5.5 kA
Coil weight	approx. 50 kg	approx. 50 kg	approx. 18.5 kg
PU	127 m	81 m	30 m



Steel wire, straightened, cut into bars

With zinc coating ≥ 50 µm on average (about 350 g/m²). Suitable for installation in reinforcements (e.g. concrete supports).

Part No.	800 910	800 911
Diameter Ø conductor	10 mm	10 mm
Cross-section	78 mm ²	78 mm ²
Material	St/tZn	St/tZn
Standard	based on EN 62561-2	based on EN 62561-2
Short-circuit current (50 Hz) (1 s; ≤ 300 °C)	5.5 kA	5.5 kA
Length	3 m	6 m
PU	10 pc(s)	1 pc(s)



Steel wire with plastic sheath

With plastic sheath as additional mechanical / corrosion protection, e.g. when connected to the lightning protection system. Suitable for installation on, in and under plaster, mortar or concrete.

Part No.	800 108	800 110
Diameter Ø conductor	8 mm	10 mm
Cross-section	50 mm ²	78 mm ²
Material	St/tZn	St/tZn
Standard	based on EN 62561-2	based on EN 62561-2
Outside diameter Ø	11 mm	13 mm
Material of sheath	plastic	plastic
Sheath thickness	1.5 mm	1.5 mm
Coil weight	approx. 33 kg	approx. 34 kg
PU	75 m	50 m





Copper wire

Part No.	830 008	830 108	830 038
Diameter Ø conductor	8 mm	8 mm	8 mm
Cross-section	50 mm ²	50 mm ²	50 mm ²
Material	Cu	Cu	Cu
Characteristics	soft F20	soft F20	semi-rigid F25
Standard	EN 62561-2	EN 62561-2	EN 62561-2
Short-circuit current (50 Hz) (1 s; ≤ 300 °C)	9.8 kA	9.8 kA	9.8 kA
Coil weight	approx. 45 kg	approx. 9 kg	approx. 45 kg
PU	100 m	20 m	100 m

DEHNalu wire

Part No.	840 008	840 108	840 018
Diameter Ø conductor	8 mm	8 mm	8 mm
Cross-section	50 mm ²	50 mm ²	50 mm ²
Material	AlMgSi	AlMgSi	AlMgSi
Characteristics	semi-rigid	semi-rigid	soft, twistable
Standard	EN 62561-2	EN 62561-2	based on EN 62561-2
Coil weight	approx. 20 kg	approx. 3 kg	approx. 20 kg
PU	148 m	21 m	148 m

Part No.	840 028	840 010
Diameter Ø conductor	8 mm	10 mm
Cross-section	50 mm ²	78 mm ²
Material	AlMgSi	Al
Characteristics	soft, twistable	soft, twistable
Standard	based on EN 62561-2	EN 62561-2
Coil weight	approx. 3 kg	approx. 21 kg
PU	21 m	100 m

Note: Al and AlMgSi may not be installed directly (without a gap) on, in, or under plaster, mortar or concrete, and also not in soil.

DEHNalu wire with plastic sheath

Wire with plastic sheath (halogen-free, frost-resistant and UV-stabilised) as additional mechanical / corrosion protection, e.g. when installed behind facades.

Part No.	840 118	840 128
Diameter Ø conductor	8 mm	8 mm
Cross-section	50 mm ²	50 mm ²
Material	AlMgSi	Al
Characteristics	soft	soft
Standard	based on EN 62561-2	EN 62561-2
Outside diameter Ø	11 mm	11 mm
Material of sheath	plastic	plastic
Sheath thickness	1.5 mm	1.5 mm
Coil weight	approx. 20 kg	approx. 20 kg
PU	100 m	100 m

DEHNcupal wire

New composite material. Lighter than copper.

For use above ground as an air-termination and down conductor, or for equipotential bonding.

Part No.	833 008
Diameter Ø conductor	8 mm
Cross-section	50 mm ²
Material	Al / Cu
Characteristics	soft, twistable
Standard	based on EN 62561-2
Cu sheath	min. 0.26 mm
Coil weight	approx. 20 kg
PU	110 m

Note: DEHNcupal wire can be twisted or straightened using a wire straightening device.

Conductor materials can only be supplied in the original coil weights.
Further conductor materials as specified in the standard series EN 62561-2 are available on request.

Strips

According to EN 62561-2, for use in earth-termination and lightning protection systems as well as for ring equipotential bonding.

Steel strip

Zinc coating $\geq 70 \mu\text{m}$ on average (approx. 500 g/m²).

General technical data:			
Material	St/tZn		
Part No.	810 225	810 335	852 335
Width	20 mm	30 mm	30 mm
Thickness	2.5 mm	3.5 mm	3.5 mm
Cross-section	50 mm ²	105 mm ²	105 mm ²
Standard	based on EN 62561-2	EN 62561-2	EN 62561-2
Short-circuit current (50 Hz) (1 s; $\leq 300 \text{ }^\circ\text{C}$)	—	7.3 kA	7.3 kA
Coil weight	approx. 40 kg	approx. 42 kg	approx. 21 kg
PU	100 m	50 m	25 m
Part No.	810 304	810 404	810 405
Width	30 mm	40 mm	40 mm
Thickness	4 mm	4 mm	5 mm
Cross-section	120 mm ²	160 mm ²	200 mm ²
Standard	EN 62561-2	EN 62561-2	EN 62561-2
Short-circuit current (50 Hz) (1 s; $\leq 300 \text{ }^\circ\text{C}$)	8.4 kA	11.2 kA	14 kA
Coil weight	approx. 50 kg	approx. 50 kg	approx. 50 kg
PU	52 m	40 m	30 m



Copper strip

Part No.	831 225
Width	20 mm
Thickness	2.5 mm
Cross-section	50 mm ²
Material	Cu
Standard	EN 62561-2
Short-circuit current (50 Hz) (1 s; $\leq 300 \text{ }^\circ\text{C}$)	9.8 kA
Coil weight	approx. 45 kg
PU	100 m



Stainless steel strip

General technical data:			
Standard	EN 62561-2		
Part No.	860 925	860 900	860 325
Width	30 mm	30 mm	30 mm
Thickness	3.5 mm	3.5 mm	3.5 mm
Cross-section	105 mm ²	105 mm ²	105 mm ²
Material	StSt	StSt	StSt (V4A)
Material No.	1.4301 / 1.4303	1.4301 / 1.4303	1.4571 / 1.4404
Short-circuit current (50 Hz) (1 s; $\leq 300 \text{ }^\circ\text{C}$)	—	—	3.9 kA
Coil weight	approx. 21 kg	approx. 49 kg	approx. 21 kg
PU	25 m	60 m	25 m
Part No.	860 335	860 404	860 405
Width	30 mm	40 mm	40 mm
Thickness	3.5 mm	4 mm	5 mm
Cross-section	105 mm ²	160 mm ²	200 mm ²
Material	StSt (V4A)	StSt (V4A)	StSt (V4A)
Material No.	1.4571 / 1.4404	1.4571 / 1.4404	1.4571 / 1.4404
Short-circuit current (50 Hz) (1 s; $\leq 300 \text{ }^\circ\text{C}$)	3.9 kA	—	—
Coil weight	approx. 49 kg	approx. 50 kg	approx. 50 kg
PU	60 m	40 m	30 m



Strips in different dimensions and materials are available upon request.

Cables

1 Conductor material



For use in lightning protection and earth-termination systems.

Aluminium cable

e.g. for isolated air-termination systems (DEHNiso Combi).



Part No.	840 050
Cross-section	50 mm ²
Cable structure qty x Ø wire	19 x 1.8 mm
Material	Al
Standard	EN 62561-2
Outside diameter Ø	9 mm
Coil weight	approx. 13.5 kg
PU	100 m

Note: Al must not be installed directly (without distance) on, in or under plaster, mortar or concrete, and not in soil.

Steel cable



Part No.	801 050
Cross-section	42 mm ²
Cable structure qty x Ø wire	[6x] 19 x 0.65 mm
Material	St/gal Zn
Outside diameter Ø	10 mm
Coil weight	approx. 33 kg
PU	100 m

Stainless steel cable

e.g. for equipotential bonding.



Part No.	850 008	850 010
Cross-section	27 mm ²	42 mm ²
Cable structure qty x Ø wire	[7x] 19 x ca. 0.59 mm	[7x] 19 x ca. 0.68 mm
Material	StSt (V4A)	StSt (V4A)
Material No.	1.4571 / 1.4404	1.4571 / 1.4404
Outside diameter Ø	8 mm	10 mm
Coil weight	approx. 23.5 kg	approx. 39.5 kg
PU	100 m	100 m

Copper cable

General technical data:	
Material	Cu
Standard	EN 62561-2

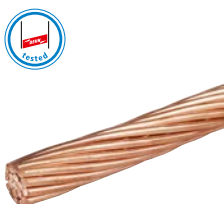

Part No.	832 739	832 740	832 192
Cross-section	50 mm ²	50 mm ²	70 mm ²
Cable structure qty x Ø wire	19 x 1.8 mm	19 x 1.8 mm	19 x 2.1 mm
Outside diameter Ø	9 mm	9 mm	10.5 mm
Short-circuit current (50 Hz) (1 s; ≤ 300 °C)	9.8 kA	9.8 kA	13.6 kA
Coil weight	approx. 22 kg	approx. 44 kg	approx. 30 kg
PU	50 m	100 m	50 m

Part No.	832 193	832 095	832 120
Cross-section	70 mm ²	95 mm ²	120 mm ²
Cable structure qty x Ø wire	19 x 2.1 mm	19 x 2.5 mm	19 x 2.8 mm
Outside diameter Ø	10.5 mm	12.5 mm	14.5 mm
Short-circuit current (50 Hz) (1 s; ≤ 300 °C)	13.6 kA	18.5 kA	23.4 kA
Coil weight	approx. 60 kg	approx. 42 kg	approx. 53 kg
PU	100 m	50 m	50 m

Round Wires, Strips, Cables

Tinned copper cable

General technical data:			
Material	Cu/gal Sn		
Part No.	832 838	832 839	832 202
Cross-section	35 mm ²	50 mm ²	70 mm ²
Cable structure qty x Ø wire	7 x 2.5 mm	19 x 1.8 mm	19 x 2.1 mm
Standard	—	EN 62561-2	EN 62561-2
Outside diameter Ø	7.5 mm	9 mm	10.5 mm
Short-circuit current (50 Hz) (1 s; ≤ 150 °C)	5 kA	7.2 kA	10.1 kA
Coil weight	approx. 33 kg	approx. 44 kg	approx. 30 kg
PU	100 m	100 m	50 m
Part No.	832 292	832 295	832 320
Cross-section	70 mm ²	95 mm ²	120 mm ²
Cable structure qty x Ø wire	19 x 2.1 mm	19 x 2.5 mm	19 x 2.8 mm
Standard	EN 62561-2	EN 62561-2	EN 62561-2
Outside diameter Ø	10.5 mm	12.5 mm	14.5 mm
Short-circuit current (50 Hz) (1 s; ≤ 150 °C)	10.1 kA	13.8 kA	17.3 kA
Coil weight	approx. 60 kg	approx. 42 kg	approx. 53 kg
PU	100 m	50 m	50 m



Conductor material

Cables in different dimensions and materials are available upon request.

DEHNIT Earthing Method

For improving and stabilising the earth electrode resistance.

Highly swellable, powdery and extremely moisture retaining special clay provides a conductive earth electrode enclosure and reduces the soil resistivity.

More information at www.dehn-international.com/.

Part No.	573 000
Material	special clay
Mixing ratio	5 parts sand / 1 part DEHNIT / 0.5 parts water
Weight	25 kg
PU	25 kg



Earth Entry Rod Set

Complete with disconnecting sleeve and connection clamps (KS screws).

Type St/tZn

With disconnecting sleeve (Part No. 450 000) and KS screws (Part No. 300 000).

Part No.	480 150
Material	St/tZn
Standard	EN 62561-(1+2)
Length	1500 mm
Connection KS screw Rd	7-10 mm
Connection sleeve Rd / Rd	7-10 / 16 mm
PU	1 pc(s)



Type Cu

With disconnecting sleeve (Part No. 450 007) and KS screws (Part No. 300 007).

Part No.	480 157
Material	Cu
Standard	EN 62561-(1+2)
Length	1500 mm
Connection KS screw Rd	6-10 mm
Connection sleeve Rd / Rd	7-10 / 16 mm
PU	1 pc(s)

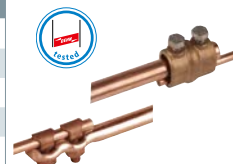

Earth Entry Rods

For connecting down conductors to the earth-termination system.

Chamfered

General technical data:			
Standard	EN 62561-2		
Diameter Ø	16 mm		
Part No.	483 150	483 200	104 903
Material	St/tZn	St/tZn	StSt (V4A)
Material No.	—	—	1.4571 / 1.4404 / 1.4401
ASTM / AISI:	—	—	316Ti / 316L / 316
Length	1500 mm	2000 mm	1000 mm
PU	10 pc(s)	10 pc(s)	10 pc(s)
Part No.	104 905	104 906	
Material	StSt (V4A)	StSt (V4A)	
Material No.	1.4571 / 1.4404 / 1.4401	1.4571 / 1.4404 / 1.4401	
ASTM / AISI:	316Ti / 316L / 316	316Ti / 316L / 316	
Length	1500 mm	2000 mm	
PU	10 pc(s)	10 pc(s)	



With forged flat lug

Hole Ø11 mm, hole distance 22 mm.

Part No.	101 150
Material	St/tZn
Standard	EN 62561-2
Diameter Ø	16 mm
Length	1500 mm
Hole distance	22 mm
PU	10 pc(s)



Tapered

Notched conductor Ø10 mm, partly insulated (length approx. 700 mm).

Part No.	480 018	480 019	480 020	480 021
Material	St/tZn	St/tZn	St/tZn	St/tZn
Standard	EN 62561-2	EN 62561-2	EN 62561-2	EN 62561-2
Diameter Ø	16 / 10 mm	16 / 10 mm	16 / 10 mm	16 / 10 mm
Total length	1500 mm	1750 mm	2000 mm	2500 mm
Partial length Ø16 mm	1000 mm	750 mm	1000 mm	1500 mm
Partial length Ø10 mm	500 mm	1000 mm	1000 mm	1000 mm
PU	10 pc(s)	10 pc(s)	10 pc(s)	10 pc(s)



Straightened / Angled Connection Lugs

For connecting down conductors to the earth-termination system; made of corrosion-resistant stainless steel.

Round wires

Part No.	860 110	860 115	860 130
Material	StSt (V4A)	StSt (V4A)	StSt (V4A)
Material No.	1.4571 / 1.4404	1.4571 / 1.4404	1.4571 / 1.4404
ASTM / AISI:	316Ti / 316L	316Ti / 316L	316Ti / 316L
Length	1000 mm	1500 mm	3000 mm
Dimensions	Ø10 mm	Ø10 mm	Ø10 mm
Cross-section	78 mm ²	78 mm ²	78 mm ²
Standard	EN 62561-2	EN 62561-2	EN 62561-2
PU	5 pc(s)	5 pc(s)	5 pc(s)



1 Conductor material

Flat strips

Part No.	860 210	860 215	860 230
Material	StSt (V4A)	StSt (V4A)	StSt (V4A)
Material No.	1.4571 / 1.4404	1.4571 / 1.4404	1.4571 / 1.4404
ASTM / AISI:	316Ti / 316L	316Ti / 316L	316Ti / 316L
Length	1000 mm	1500 mm	3000 mm
Dimensions	30 x 3.5 mm	30 x 3.5 mm	30 x 3.5 mm
Cross-section	105 mm ²	105 mm ²	105 mm ²
Standard	EN 62561-2	EN 62561-2	EN 62561-2
PU	5 pc(s)	5 pc(s)	5 pc(s)



Flat strips with holes

Holes at intervals of 500 mm.

Part No.	860 425	860 430
Material	StSt	StSt (V4A)
Material No.	1.4301	1.4571 / 1.4404
ASTM / AISI:	—	316Ti / 316L
Length	3000 mm	3000 mm
Dimensions	30 x 3.5 mm	30 x 3.5 mm
Fixing	[6x] 6.5 x 12 mm	[6x] 6.5 x 12 mm
Hole distance	500 mm	500 mm
Cross-section	105 mm ²	105 mm ²
Standard	EN 62561-2	EN 62561-2
PU	5 pc(s)	5 pc(s)



Flat strips, angled

For wall mounting (without a gap) with holes for countersunk head screws.

Part No.	860 315	860 330
Material	StSt (V4A)	StSt (V4A)
Material No.	1.4571 / 1.4404	1.4571 / 1.4404
ASTM / AISI:	316Ti / 316L	316Ti / 316L
Length	1500 mm	3000 mm
Dimensions	30 x 3.5 mm	30 x 3.5 mm
Connection	disconnecting clamp or KS connector	disconnecting clamp or KS connector
Fixing	[3x] Ø6.5 mm	[6x] Ø6.5 mm
Hole distance	500 mm	500 mm
Cross-section	105 mm ²	105 mm ²
Standard	EN 62561-2	EN 62561-2
PU	5 pc(s)	5 pc(s)



Other dimensions are available upon request.

Marker for Connection Lugs

Attached to round wires or strips to make them conspicuous (as required by DIN 18014) during the construction work.

Part No.	478 099
Material	PVC
Diameter Ø	70 mm
Fits on Fl	30 x 3.5 mm
Fits on Rd	10 mm
Colour	green ● / yellow ●
PU	20 pc(s)





DEHN protects.

Fixed Earthing Terminals

For installation in concrete as a corrosion-free connection to the earth-termination system for protective equipotential bonding and / or functional equipotential bonding of the down conductor, e.g. to the reinforcement of buildings.

Please observe the following minimum screw lengths for the M10 and M12 double threads:

35 mm of M10 (thread length 40 mm)

15 mm of M12 (thread length 20 mm)

Type M

With connecting shaft (l = 180 mm, Ø10 mm).

Part No.	478 011	478 019
Connection thread	M10 / M12	M10 / M12
Material of plate	StSt (V4A)	StSt (V4A)
Material No.	1.4571 / 1.4404 / 1.4401	1.4571 / 1.4404 / 1.4401
ASTM / AISI:	316Ti / 316L / 316	316Ti / 316L / 316
Material of shaft	St/tZn	StSt
Connection plate Ø	80 mm	80 mm
Short-circuit current (50 Hz) (1 s; ≤ 300 °C)	6.5 kA	3.9 kA
Standard	EN 62561-1	EN 62561-1
PU	10 pc(s)	10 pc(s)



Type M without connecting shaft

Part No.	478 012
Connection thread	M10 / M12
Material of plate	StSt (V4A)
Material No.	1.4571 / 1.4404 / 1.4401
ASTM / AISI:	316Ti / 316L / 316
Connection plate Ø	80 mm
Short-circuit current (50 Hz) (1 s; ≤ 300 °C)	9.3 kA (with copper cable lug)
Standard	EN 62561-1
PU	10 pc(s)



Type M, press-fitted Connecting shaft (l = 180 mm, Ø10 mm).

Part No.	478 041	478 049
Connection thread	M10 / M12	M10 / M12
Material of plate	StSt (V4A)	StSt (V4A)
Material No.	1.4571 / 1.4404 / 1.4401	1.4571 / 1.4404 / 1.4401
ASTM / AISI:	316Ti / 316L / 316	316Ti / 316L / 316
Material of shaft	St/tZn	StSt
Connection plate Ø	80 mm	80 mm
Short-circuit current (50 Hz) (1 s; ≤ 300 °C)	3.7 kA	3.3 kA
Standard	EN 62561-1	EN 62561-1
PU	10 pc(s)	10 pc(s)

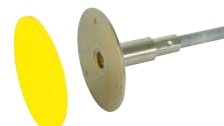

Part No. 478 049 with UL approval.

Type M, press-fitted, with additional water barrier

Protection against water ingress along the shaft into the wall (tested according to EN 62561-5 with 5 bar compressed air and 1 bar pressure water). Suitable for waterproof concrete.

Part No.	478 051
Connection thread	M10 / M12
Material of plate	StSt (V4A)
Material No.	1.4571 / 1.4404 / 1.4401
ASTM / AISI:	316Ti / 316L / 316
Material of shaft	St/tZn
Connection plate Ø	80 mm
Short-circuit current (50 Hz) (1 s; ≤ 300 °C)	3.7 kA
Material of water barrier	PVC
Standard	EN 62561-1
PU	1 pc(s)



Type M with MV clamp

For round conductors 8-10 mm, space-saving installation in the formwork.

Part No.	478 112
Connection thread	M10 / M12
Material of plate	StSt (V4A)
Material No.	1.4571 / 1.4404 / 1.4401
ASTM / AISI:	316Ti / 316L / 316
Material of MV clamp	St/tZn
Connection plate Ø	80 mm
Short-circuit current (50 Hz) (1 s; ≤ 300 °C)	9.3 kA
Standard	EN 62561-1
PU	10 pc(s)



Type K

With plastic ring and connecting shaft (l = 180 mm, Ø10 mm).



Part No.	478 200
Connection thread	M10 / M12
Material of plate	StSt (V4A)
Material No.	1.4571 / 1.4404 / 1.4401
ASTM / AISI:	316Ti / 316L / 316
Material of shaft	St/tZn
Connection plate Ø	46 mm
Short-circuit current (50 Hz) (1 s; ≤ 300 °C)	6.5 kA
Standard	EN 62561-1
PU	10 pc(s)

Accessory for Fixed Earthing Terminals

Foam pad

Foam pad is attached to the yellow protective cover of the fixed earthing terminal (see installation instructions DS1476). One side adhesive, with pull-off tab.

Using the foam pad enables a position compensation of approx. 20 mm at the formwork and makes it easier to find and expose the fixed earthing terminal after concreting.



Part No.	478 098
Diameter Ø	90 mm
Height	20 mm
PU	10 pc(s)

Fixed Earthing Terminal M16



With M16 connection thread for higher current loads (50 Hz), e.g. for connecting the ring equipotential bonding system with the earth-termination systems of power installations with nominal AC voltages over 1 kV (transformer earthing).



Part No.	478 027
Connection thread	M16
Material of plate	StSt (V4A)
Material No.	1.4571 / 1.4404 / 1.4401
ASTM / AISI:	316Ti / 316L / 316
Material of cable	Cu/gal Sn
Cross-section of connecting cable	70 mm ²
Length of connecting cable	400 mm
Diameter Ø connecting cable	10.5 mm
Connection plate Ø	80 mm
Standard	EN 62561-1
Short-circuit current (50 Hz) (1 s; ≤ 300 °C)	11 kA
PU	1 pc(s)

Connecting Clamps for Fixed Earthing Terminals and Reinforcements

For connecting the reinforcement with clamping piece.

For round conductors or fixed earthing terminals with simultaneous fixing in the formwork.

Arrangement:

(||) = parallel

(+) = cross



For small diameters

Part No.	308 035
Material	St/bare
Clamping range Rd / Rd	(+) 6-22 / 6-10 mm
Clamping range Rd / Fl	(+) 6-22 / 40 mm
Screw	☐ M10 x 60 mm
Standard	EN 62561-1
Short-circuit current (50 Hz) (1 s; ≤ 300 °C)	1.0 kA
PU	25 pc(s)

U-clamp for large diameters

Part No.	308 046
Material	St/bare
Clamping range Rd / Rd	(+//II) 16-48 / 6-10 mm
Clamping range Rd / Fl	(II) 16-48 / 30-40 mm
Screw	U-bolt M10 x 48 mm
Standard	EN 62561-1
Short-circuit current (50 Hz) (1 s; ≤ 300 °C)	9.9 kA
PU	25 pc(s)



End Pieces

Screwed to the fixed earthing terminal to connect, e.g. an equipotential bonding bar or structural parts such as steel girders, etc.

Basic design

Universal use for M10 and M12 connections, e.g. at the fixed earthing terminal.
For connection of Rd, e.g. with KS connector (Part No. 301 019), or Fl with M10 or M12 screws and nuts.

Part No.	390 499
Material	StSt
Hole Ø	10.5 / 12.5 mm
PU	50 pc(s)



Design with square holes

Dimensions 11x11 mm, for connecting Rd, e.g. with KS connector (Part No. 301 019), or Fl with M10 screws and nuts.

Part No.	390 479
Material	StSt
Distance of holes	30 mm
Hole Ø	13 mm
PU	50 pc(s)



Design with holes and KS connector

With holes Ø11 mm.

Part No.	363 010
Material	St/tZn
Distance of holes	22 mm
Hole Ø	11 mm
Clamping range Rd	7-10 mm
Standard	EN 62561-1
PU	50 pc(s)



Design with holes

With holes Ø11 mm.

Part No.	363 000
Material	St/tZn
Distance of holes	22 mm
Hole Ø	11 mm
PU	50 pc(s)



Connection Clamps with Threaded Bolt

For connecting round and flat conductors to fixed earthing terminals with M10 / M12 thread (e.g. Part Nos. 478 011, 478 200) and M16 thread (Part No. 478 027). Clamps with M10 thread are also suitable for installation on the rear side of the fixed earthing terminal (without connecting shaft), e.g. to connect a flat strip.



Heavy design M10

Part No.	478 141
Material of clamp	St/tZn
Clamping range Rd / Fl	7-10 / 30-40 mm
Dimensions	70 x 70 x 3 mm
Standard	EN 62561-1
PU	10 pc(s)



Heavy design M12

Part No.	478 149
Material of clamp	StSt (V4A)
Material No.	1.4571 / 1.4404 / 1.4401
ASTM / AISI:	316Ti / 316L / 316
Clamping range Rd / Fl	7-10 / 30-40 mm
Dimensions	70 x 70 x 3 mm
Standard	EN 62561-1
Short-circuit current (50 Hz) (1 s; ≤ 300 °C)	3.3 kA
PU	10 pc(s)



Heavy design M16

Part No.	478 150
Material of clamp	StSt (V4A)
Material No.	1.4571 / 1.4404 / 1.4401
ASTM / AISI:	316Ti / 316L / 316
Clamping range Rd / Fl	7-10 / 30-40 mm
Dimensions	70 x 70 x 3 mm
Standard	EN 62561-1
Short-circuit current (50 Hz) (1 s; ≤ 300 °C)	5.9 kA
PU	10 pc(s)



Light design M10

Part No.	478 129
Material of clamp	StSt (V4A)
Material No.	1.4571 / 1.4404 / 1.4401
ASTM / AISI:	316Ti / 316L / 316
Clamping range Rd / Fl	8-10 / 30 mm
Dimensions	58 x 30 x 2.5 mm
Standard	EN 62561-1
Short-circuit current (50 Hz) (1 s; ≤ 300 °C)	2.7 kA
PU	10 pc(s)

Threaded Adapter

For connection to fixed earthing terminals with M10 thread, lock nut and spring washer, for use in case of perimeter insulation or thermal insulation composite systems.



Part No.	478 699
Material	StSt (V4A)
Material No.	1.4571 / 1.4404 / 1.4401
ASTM / AISI:	316Ti / 316L / 316
Female thread	M10 x 25 mm
Male thread	M10 x 80 mm
Total length	130 mm
Standard	EN 62561-1
PU	10 pc(s)

Wall Bushings

With MV clamp made of StSt (V4A) for round conductors 8-10 mm. Water-pressure-tight wall bushing for leading earthing conductors / equipotential bonding conductors through brickwork or walls; with M10 threaded rod made of StSt.



For subsequent installation through borehole (Ø14 mm) or through spacer in the formwork.
Test for water pressure-tightness up to 1 bar features an installation depth of 10 m in stagnant water.

Part No.	478 410	478 430	478 450
Length of bushing	100-300 mm	300-500 mm	500-700 mm
Length of threaded rod	308 mm	508 mm	708 mm
Sealings	Neoprene	Neoprene	Neoprene
Sealing disc Ø	80 mm	80 mm	80 mm
Material of disc	StSt (V4A)	StSt (V4A)	StSt (V4A)
Material No.	1.4571 / 1.4404 / 1.4401	1.4571 / 1.4404 / 1.4401	1.4571 / 1.4404 / 1.4401
ASTM / AISI:	316Ti / 316L / 316	316Ti / 316L / 316	316Ti / 316L / 316
Short-circuit current (50 Hz) (1 s; ≤ 300 °C)	2.7 kA	2.7 kA	2.7 kA
Standard	EN 62561-1	EN 62561-1	EN 62561-1
PU	1 pc(s)	1 pc(s)	1 pc(s)



Water Pressure-tight Wall Bushings for White Tank

For installation in the formwork.

Water-pressure-tight wall bushing, e.g. for connecting the ring earth electrode with the equipotential bonding bar or the equipotential bonding conductor in the foundation.

Pressurised water test up to 1 bar represents an installation depth of 10 m in stagnant water.

Tested with 5 bar compressed air in accordance with EN 62561-5.



Part No.	478 530	478 540	478 550
Material of plate	StSt (V4A)	StSt (V4A)	StSt (V4A)
Material No.	1.4571 / 1.4404 / 1.4401	1.4571 / 1.4404 / 1.4401	1.4571 / 1.4404 / 1.4401
ASTM / AISI:	316Ti / 316L / 316	316Ti / 316L / 316	316Ti / 316L / 316
Material of axis	St/tZn	St/tZn	St/tZn
Wall thickness	200-300 mm	300-400 mm	400-500 mm
Connection thread	M10 / 12	M10 / 12	M10 / 12
Connection plate Ø	80 mm	80 mm	80 mm
Short-circuit current (50 Hz) (1 s; ≤ 300 °C)	4.1 kA	4.1 kA	4.1 kA
Standard	EN 62561-(1+5)	EN 62561-(1+5)	EN 62561-(1+5)
PU	1 pc(s)	1 pc(s)	1 pc(s)



Sealing Collar for Connection Lug

Sealing collar for bushings in case of watertight foundation slabs / walls (e.g. white tank).

Water-pressure-tight for pushing on round / flat conductors with StSt tensioning straps.

Pressurised water test up to 1 bar represents an installation depth of 10 m in stagnant water, additionally tested with 5 bar compressed air according to EN 62561-5.



For round conductors

Part No.	478 598
Material	thermoplast elastomer
Diameter Ø	105 mm
Bushing Rd	10 mm
Standard	EN 62561-5
PU	10 pc(s)



For flat conductors

Part No.	478 599
Material	thermoplast elastomer
Diameter Ø	119 mm
Bushing Fl	30 x 3.5 mm
Standard	EN 62561-5
PU	10 pc(s)





DEHN protects.

Connecting Clamps for Reinforcements

In accordance with the German standard DIN 18014: 2014-03 Fundamenteerde – Planung, Ausführung und Dokumentation (Foundation earth electrode - Planning, execution and documentation), foundation earth electrodes have to be connected with the reinforcement of the foundation slab at intervals of 2 metres. Of the various connection possibilities, clamp connections have turned out to be the most economic as they can be implemented quickly and easily on site.

According to the current lightning protection standards, reinforcing steels should, among other things, be used as natural components of the down conductor system. The table below provides an overview of the nominal and outer diameters as well as cross sections of the reinforcing steels DIN EN 10080: 2005.

For connecting concrete reinforcing mats or reinforcements with round and flat conductors.

Arrangement: (||) = parallel (+) = cross



The outer diameter including corrugation is approx. $d_A = 1.15 \times d_s$.

Nominal diameter d_s (mm)	6	8	10	12	14	16	20	25	28	32	40
Average outer diameter incl. corrugation d_A (mm)	7.1	9.4	11.8	14.2	16.5	18.9	23.6	29.5	33.1	37.8	47.2
Nominal cross section (mm ²)	28.3	50.3	78.5	113.1	154	201	314	491	616	804	1257

DEHNclip Rebar Clamp

Quick and safe:

DEHNclip rebar clamp for quick connection of the earth electrode to the reinforcement without tools. DEHNclip is tested for a lightning current carrying capability of 50 kA (10/350 μ s) in accordance with EN 62561-1.



For connecting round conductors with the reinforcement

Part No.	308 130	308 131	308 132	308 133
Material	St/bare	St/bare	St/bare	St/bare
Clamping range Rd^* / Rd	6-7 / 10 mm	8-9 / 10 mm	10 / 10 mm	12 / 10 mm
Short-circuit current (50 Hz) (1 s; ≤ 300 °C)	2.5 kA	2.7 kA	2.4 kA	2.7 kA
Standard	EN 62561-1	EN 62561-1	EN 62561-1	EN 62561-1
PU	50 pc(s)	50 pc(s)	50 pc(s)	50 pc(s)



^{*)} Nominal diameter d_s of the reinforcement

For connecting flat conductors with the reinforcement

Part No.	308 140	308 141	308 142	308 143
Material	St/bare	St/bare	St/bare	St/bare
Clamping range Rd^* / Fl	6-7 / 30 mm	8-9 / 30 mm	10 / 30 mm	12 / 30 mm
Short-circuit current (50 Hz) (1 s; ≤ 300 °C)	2.0 kA	2.3 kA	2.3 kA	2.3 kA
Standard	EN 62561-1	EN 62561-1	EN 62561-1	EN 62561-1
PU	50 pc(s)	50 pc(s)	50 pc(s)	50 pc(s)



^{*)} Nominal diameter d_s of the reinforcement

For connecting reinforcing steel

Part No.	308 134	308 135	308 137	308 136
Material	St/bare	St/bare	St/bare	St/bare
Clamping range Rd^* / Rd^*	6-7 / 6-7 mm	8-9 / 8-9 mm	8-9 / 12 mm	12 / 12 mm
Short-circuit current (50 Hz) (1 s; ≤ 300 °C)	2.2 kA	2.4 kA	2.4 kA	2.6 kA
Standard	EN 62561-1	EN 62561-1	EN 62561-1	EN 62561-1
PU	50 pc(s)	50 pc(s)	50 pc(s)	50 pc(s)



^{*)} Nominal diameter d_s of the reinforcement

Connecting Clamps for Reinforcements

For T, cross and parallel connections



Part No.	308 025
Material	St/tZn
Clamping range Rd / Rd	(+) 6-10 / 6-10 mm
Clamping range Rd / Fl	(+) 6-10 / 30 mm
Clamping range Fl / Fl	(II) 30 / 30 mm
Screw	☛ ● M10 x 25 mm
Short-circuit current (50 Hz) (1 s; ≤ 300 °C)	9 kA
Standard	EN 62561-1
PU	50 pc(s)

For T, cross and parallel connections



Part No.	308 026
Material	St/tZn
Clamping range Rd / Fl	(+) 6-10 / 30 mm
Clamping range Fl / Fl	(+ / II) 30 / 30 mm
Screw	☛ ● M10 x 25 mm
Short-circuit current (50 Hz) (1 s; ≤ 300 °C)	13 kA
Standard	EN 62561-1
PU	25 pc(s)

For T and cross connections

Note: recommended tightening torque ≥ 10 Nm



Part No.	308 030
Material	St/bare
Clamping range Rd / Fl	(+) 6-22 / 30-40 mm
Screw	☛ ● M10 x 40 mm
Short-circuit current (50 Hz) (1 s; ≤ 300 °C)	1.0 kA
Standard	EN 62561-1
PU	50 pc(s)

For T, cross and parallel connections with clamping piece

For flexible connection of round conductors or for fixed earthing terminals while fixing in the formwork.



Part No.	308 035
Material	St/bare
Clamping range Rd / Rd	(+/II) 6-22 / 6-10 mm
Clamping range Rd / Fl	(+) 6-22 / 40 mm
Screw	☛ ● M10 x 60 mm
Short-circuit current (50 Hz) (1 s; ≤ 300 °C)	1.0 kA
Standard	EN 62561-1
PU	25 pc(s)

U-bolt clamp for large diameters



Part No.	308 045
Material	St/bare
Clamping range Rd / Rd	(II) 16-48 / 6-10 mm
Clamping range Rd / Fl	(II) 16-48 / 30-40 mm
Screw	U-bolt M10 x 48 mm
Short-circuit current (50 Hz) (1 s; ≤ 300 °C)	16 kA
Standard	EN 62561-1
PU	25 pc(s)

U-bolt clamp for large diameters with two additional clamping pieces

For cross connections of round conductors (6-10 mm) or for fixing and simultaneous connection of fixed earthing terminals.

Part No.	308 046
Material	St/bare
Clamping range Rd / Rd	(+//II) 16-48 / 6-10 mm
Clamping range Rd / Fl	(II) 16-48 / 30-40 mm
Screw	U-bolt M10 x 48 mm
Short-circuit current (50 Hz) (1 s; ≤ 300 °C)	9.9 kA
Standard	EN 62561-1
PU	25 pc(s)



MAXI MV clamps

For T, cross and parallel connections.

Part No.	308 041	308 040
Material	St/tZn	St/bare
Clamping range Rd / Rd	(+//II) 8-16 / 15-25 mm	(+//II) 8-16 / 15-25 mm
Screw	☒ M12 x 65 mm	☒ M12 x 65 mm
Short-circuit current (50 Hz) (1 s; ≤ 300 °C)	6.2 kA	10.2 kA
Standard	EN 62561-1	EN 62561-1
UL certification	—	UL467B
Stock No.	5999-12-362-1557	—
PU	20 pc(s)	20 pc(s)



MV clamps with hexagon screw

Threaded base part.

Part No.	390 050	391 050
Material	St/tZn	St/tZn
Clamping range Rd	8-10 mm	10 mm
Screw	☒ M10 x 30 mm	☒ M10 x 35 mm
Short-circuit current (50 Hz) (1 s; ≤ 300 °C)	5.5 kA	—
Standard	EN 62561-1	EN 62561-1
PU	50 pc(s)	50 pc(s)



MV clamps with hexagon screw and spring washer

Threaded base part.

Part No.	390 550
Material	St/tZn
Clamping range Rd	8-10 mm
Screw	☒ M10 x 30 mm
Standard	EN 62561-1
PU	50 pc(s)



Parallel connectors with truss head screw

Part No.	306 121	306 122
Material	St/bare	St/tZn
Clamping range Rd / Rd	6-22 / 6-22 mm	6-22 / 6-22 mm
Screw	☒ M10 x 40 mm	☒ M10 x 40 mm
Short-circuit current (50 Hz) (1 s; ≤ 300 °C)	6.1 kA	6.1 kA
Standard	EN 62561-1	EN 62561-1
PU	50 pc(s)	50 pc(s)



Connecting Clamps for Foundation Earth Electrodes

For connecting round and flat conductors in the concrete foundation.
For T, cross and parallel connections, without having to insert the conductor.

Arrangement:

(//) = parallel

(+) = cross



Part No.	308 120	308 129
Material	St/tZn	StSt
Clamping range Rd / Fl	(+) 10 / 30 mm	(+) 10 / 30 mm
Clamping range Fl / Fl	(+//) 30 / 30 mm	(+//) 30 / 30 mm
Standard	EN 62561-1	EN 62561-1
PU	25 pc(s)	25 pc(s)

Connecting Clamps for Foundation Earth Electrodes and Reinforcements

For connecting round and flat conductors in the concrete foundation or reinforcing steel meshes and reinforcements with round and flat conductors.

Arrangement:

(//) = parallel

(+) = cross



Connecting clamp with thrust bracket

For T, cross and parallel connections.

Part No.	308 031
Material	St/bare
Clamping range Rd / Rd	(+//) 6-20 / 8-10 mm
Clamping range Rd / Fl	(+//) 6-20 / 30 x 3-4 mm
Clamping range Fl / Fl	(+//) 30 x 3-4 / 30 x 3-4 mm
Short-circuit current (50 Hz) (1 s; ≤ 300 °C)	8.4 kA
Standard	EN 62561-1
PU	25 pc(s)



Connecting clamp MAXI with thrust bracket

For T, cross and parallel connections.

Part No.	308 036
Material	St/bare
Clamping range Rd / Rd	(+//) 20-32 / 8-10 mm
Clamping range Rd / Fl	(+//) 20-32 / 40 x 4-5 mm
Short-circuit current (50 Hz) (1 s; ≤ 300 °C)	14.0 kA
Standard	EN 62561-1
PU	25 pc(s)



Connecting clamp without thrust bracket

For cross connections.

Part No.	308 032
Material	St/bare
Clamping range Rd / Fl	(+) 6-20 / 30 x 3-4 mm
Clamping range Fl / Fl	(+) 30 x 3-4 / 30 x 3-4 mm
Standard	EN 62561-1
PU	25 pc(s)



Connecting clamp MAXI without thrust bracket

For cross connections.

Part No.	308 037
Material	St/bare
Clamping range Rd / Fl	(+) 20-32 / 30 x 3-40 x 5 mm
Standard	EN 62561-1
PU	25 pc(s)

SV Clamps for Underground Connections

SV clamps (Schräg-Verbinder-Klemmen)
Diagonal connecting clamps for cross and T connections.

Part No.	308 062
Material of clamp	St/bare
Clamping range Rd / Fl	6-28 / 30 mm
Standard	EN 62561-1
Short-circuit current (50 Hz) (1 s; ≤ 300 °C)	7.3 kA
PU	50 pc(s)



SV Clamps for Aboveground and Underground Connections

Diagonal connecting clamps (Schräg-Verbinder-Klemmen) for cross and T connections, screws with anti-rotation protection.

For flat and round conductors

Part No.	308 220	308 229	308 320	308 329
Material of clamp	St/tZn	StSt (V4A)	St/tZn	StSt (V4A)
Clamping range Rd / Rd	7-10 / 7-10 mm	7-10 / 7-10 mm	7-10 / 7-10 mm	7-10 / 7-10 mm
Clamping range Rd / Fl	7-10 / 30 mm	7-10 / 30 mm	7-10 / 30-40 mm	7-10 / 30-40 mm
Clamping range Fl / Fl	30 / 30 mm	30 / 30 mm	30-40 / 30-40 mm	30-40 / 30-40 mm
Screw	⬆ M10 x 30 mm	⬆ M10 x 30 mm	⬆ M10 x 30 mm	⬆ M10 x 30 mm
ASTM / AISI:	—	316Ti / 316L / 316	—	316Ti / 316L / 316
Dimensions (l x d)	94 x 4 mm	94 x 3 mm	108 x 4 mm	108 x 3 mm
Standard	EN 62561-1	EN 62561-1	EN 62561-1	EN 62561-1
Short-circuit current (50 Hz) (1 s; ≤ 300 °C)	7.3 kA	3.2 kA	14.0 kA	14.0 kA
PU	25 pc(s)	25 pc(s)	25 pc(s)	25 pc(s)



For one flat and one round conductor

Part No.	308 249
Material of clamp	StSt (V4A)
Clamping range Rd / Fl	7-10 / 30 mm
Screw	⬆ M10 x 30 mm
ASTM / AISI:	316Ti / 316L / 316
Dimensions (l x d)	94 x 3 mm
Standard	EN 62561-1
PU	25 pc(s)



For flat conductors

Part No.	308 230	308 239
Material of clamp	St/tZn	StSt (V4A)
Clamping range Fl / Fl	30 / 30 mm	30 / 30 mm
Screw	⬆ M10 x 30 mm	⬆ M10 x 30 mm
ASTM / AISI:	—	316Ti / 316L / 316
Dimensions (l x d)	94 x 4 mm	94 x 3 mm
Standard	EN 62561-1	EN 62561-1
Short-circuit current (50 Hz) (1 s; ≤ 300 °C)	8.2 kA	3.9 kA
PU	25 pc(s)	25 pc(s)



For flat conductors, round conductors and earth entry rods

Part No.	308 330
Material of clamp	St/tZn
Clamping range Rd / Rd	7-10 / 16 mm
Clamping range Rd / Fl	16 / 30-40 mm
Screw	⬆ M10 x 30 mm
Dimensions (l x d)	108 x 4 mm
Standard	EN 62561-1
PU	25 pc(s)



Wedge Connector

For T, cross and parallel connections for use in concrete foundations.



Part No.	308 001
Material	St/tZn
Clamping range Rd / Fl	10 / 30 x 3.5-40 x 4 mm
Clamping range Fl / Fl	30 x 3.5-40 x 4 / 30 x 3.5-40 x 4 mm
PU	25 pc(s)

Expansion Strap for Foundation Earth Electrodes

For leading the foundation earth electrode through the expansion joints of large foundations (several sections). It is not necessary to lead the earth electrode out of the base plate.



Part No.	308 150
Material of strap	StSt
Dimensions of strap (l x w x d)	approx. 700 x 30 x (4 x 1) mm
Cross-section	120 mm ²
Material of block	polystyrene
Dimensions of block (l x w x d)	180 x 85 x 45 mm
Short-circuit current (50 Hz) (1 s; ≤ 300 °C)	6 kA
Standard	EN 62561-2
PU	1 pc(s)

Spacers

For the installation of earthing conductors in the foundation slab.
With catch lug to avoid loosening of the conductor.



Angled and reinforced design

Part No.	290 001
Material	St/tZn
Support Fl	40 mm
Support Rd	8-10 mm
Length	300 mm
PU	25 pc(s)



Straight design

Part No.	290 002
Material	St/tZn
Support Fl	40 mm
Support Rd	8-10 mm
Length	280 mm
PU	50 pc(s)

Earth Rods



For implementing earth-termination systems for down conductors or transformer stations.

Features:

- No cross section thickening at the coupling point
- Self-locking coupling
- Corrosion resistance
- Easier storage and transport
- Universal use according to local soil conditions
- Constant resistance values
- Easily driven in with a vibration hammer

Type Z

With triple knurled pin (coupling with especially high tensile strength).

Part No.	620 101	620 151	625 101	625 151
Material	St/tZn	St/tZn	St/tZn	St/tZn
Rod length	1000 mm	1500 mm	1000 mm	1500 mm
Diameter Ø	20 mm	20 mm	25 mm	25 mm
Short-circuit current (50 Hz) (1 s; ≤ 300 °C)	7.9 kA	7.9 kA	12.3 kA	12.3 kA
Standard	EN 62561-2	EN 62561-2	EN 62561-2	EN 62561-2
PU	6 pc(s)	6 pc(s)	6 pc(s)	6 pc(s)



Type AZ

With offset knurled pin.

Part No.	620 903	620 902
Material	StSt (V4A)	StSt (V4A)
Material No.	1.4571 / 1.4404 / 1.4401	1.4571 / 1.4404 / 1.4401
ASTM / AISI:	316Ti / 316L / 316	316Ti / 316L / 316
Rod length	1000 mm	1500 mm
Diameter Ø	20 mm	20 mm
Short-circuit current (50 Hz) (1 s; ≤ 300 °C)	4.2 kA	4.2 kA
Standard	EN 62561-2	EN 62561-2
PU	6 pc(s)	6 pc(s)



Driving Spikes

For driving in the first earth rod.

The driving spikes can be used for earth rods made of steel and StSt as well as tubular earth rods.

Part No.	620 001	625 001
Material	MCl/tZn	MCl/tZn
Type	for earth rods Ø20 mm or tubular earth rods St/tZn Ø27 mm	for earth rods Ø25 mm or tubular earth rods StSt (V4A) Ø25 mm
PU	100 pc(s)	50 pc(s)





Tubular Earth Rods

Light design, for implementing earth-termination systems for down conductors.

Type steel

Part No.	640 150
Material	St/tZn
Rod length	1500 mm
Diameter Ø	27 mm
Standard	EN 62561-2
PU	6 pc(s)

Type StSt

Part No.	649 150
Material	StSt (V4A)
Material No.	1.4571 / 1.4404 / 1.4401
ASTM / AISI:	316Ti / 316L / 316
Rod length	1500 mm
Diameter Ø	25 mm
Standard	EN 62561-2
PU	6 pc(s)

Earthing Pipe with Driving Spike

With driving spike for earthing mobile objects such as vehicles, power generators, etc.

Part No.	646 000
Material	St/tZn
Pipe Ø	34 mm
Length	600 mm
Screw	wing nut M8
Stock No.	5975-12-133-4342
PU	1 pc(s)

DEHNIT Earthing Method

For improving and stabilising the earth electrode resistance.

Highly swellable, powdery and extremely moisture retaining special clay provides a conductive earth electrode enclosure and reduces the soil resistivity.

More information at www.dehn-international.com/.

Part No.	573 000
Material	special clay
Mixing ratio	5 parts sand / 1 part DEHNIT / 0.5 parts water
Weight	25 kg
PU	25 kg

Profiled Earth Rods

For the installation of earth-termination systems e.g. for antennas or construction site distribution cabinets.

Profile 50 x 50 x 3 mm

With connection lug and holes, e.g. for KS connector.

Part No.	635 100	635 150	635 200	635 250
Material	St/tZn	St/tZn	St/tZn	St/tZn
Length	1000 mm	1500 mm	2000 mm	2500 mm
Holes Ø	[2x] 11 / [1x] 13 mm	[2x] 11 / [1x] 13 mm	[2x] 11 / [1x] 13 mm	[2x] 11 / [1x] 13 mm
Standard	EN 62561-2	EN 62561-2	EN 62561-2	EN 62561-2
PU	5 pc(s)	5 pc(s)	5 pc(s)	3 pc(s)

Single-screw Connection Clamps

For connecting round conductors, flat strips or cables to earth rods.
For cross and parallel connection.

Part No.	630 120	630 129
Material	St/tZn	StSt (V4A)
Clamping range Rd / Fl	10 / -30 x 4 mm	10 / -30 x 4 mm
Clamping range of cable	70 mm ²	70 mm ²
Type for earth rods	Ø20 mm	Ø20 mm
Material No.	—	1.4571 / 1.4404 / 1.4401
ASTM / AISI:	—	316Ti / 316L / 316
Standard	EN 62561-1	EN 62561-1
PU	25 pc(s)	25 pc(s)



Connection Brackets

For connecting round conductors, cables and flat strips to earth rods.

Diagonal design

Also for use with uncut earth conductors.

General technical data:	
Clamping range Rd / Fl	7-10 / -40 mm

Part No.	620 015	620 017	620 915
Material	St/tZn	Cu	StSt (V4A)
Clamping range (stranded / cable)	—	35-95 mm ²	35-95 mm ²
Type for earth rods	Ø20 mm	Ø20 mm	Ø20 mm
Material No.	—	—	1.4571 / 1.4404 / 1.4401
ASTM / AISI:	—	—	316Ti / 316L / 316
Short-circuit current (50 Hz) (1 s; ≤ 300 °C)	21.0 kA	29.0 kA	7.3 kA
Standard	EN 62561-1	EN 62561-1	EN 62561-1
PU	20 pc(s)	1 pc(s)	20 pc(s)



Part No.	625 015	649 015
Material	St/tZn	StSt (V4A)
Clamping range (stranded / cable)	—	35-95 mm ²
Type for earth rods	Ø25 mm	Ø25 mm
Material No.	—	1.4571 / 1.4404 / 1.4401
ASTM / AISI:	—	316Ti / 316L / 316
Short-circuit current (50 Hz) (1 s; ≤ 300 °C)	18 kA	8 kA
Standard	EN 62561-1	—
PU	20 pc(s)	20 pc(s)

Diagonal design – especially for tubular earth rods St/tZn

Also for use with uncut earth electrodes.

Part No.	640 015
Material	St/tZn
Clamping range Rd / Fl	7-10 / -40 mm
Type for earth rods	Ø27 mm
Standard	EN 62561-1
PU	1 pc(s)



One-sided connection with KS connector

Part No.	620 011	625 011
Material	St/tZn	St/tZn
Clamping range Rd	7-10 mm	7-10 mm
Type for earth rods	Ø20 mm	Ø25 mm
Standard	EN 62561-1	EN 62561-1
PU	20 pc(s)	20 pc(s)





Double-sided connection with KS connectors (St/tZn)

Part No.	620 012	625 012
Material	St/tZn	St/tZn
Clamping range Rd	7-10 mm	7-10 mm
Type for earth rods	Ø20 mm	Ø25 mm
Standard	EN 62561-1	EN 62561-1
PU	10 pc(s)	1 pc(s)



One-sided connection with M10 screw

Part No.	620 021	625 021
Material	St/tZn	St/tZn
Clamping range Fl	-40 mm	-40 mm
Type for earth rods	Ø20 mm	Ø25 mm
Short-circuit current (50 Hz) (1 s; ≤ 300 °C)	8.4 kA	8.4 kA
Standard	EN 62561-1	EN 62561-1
PU	1 pc(s)	20 pc(s)

Connection Clamps

For cross and parallel connection of round conductors, flat strips or cables to earth rods.

For earth rods Ø20-30 mm



Part No.	610 010
Material	St/tZn
Clamping range Rd / Fl	8-12.5 / -40 mm
Clamping range (stranded / cable)	50-95 mm ²
Short-circuit current (50 Hz) (1 s; ≤ 300 °C)	18 kA
Standard	EN 62561-1
PU	1 pc(s)

For earth rods Ø20-25 mm

Connection clamp for the lightning equipotential bonding connection of pipes (e.g. antenna poles) with earth rods via a solid / stranded conductor.



Part No.	540 121
Material	StSt (V4A)
Material No.	1.4571 / 1.4404 / 1.4401
ASTM / AISI:	316Ti / 316L / 316
Clamping range Rd	8-10 mm
Connection (solid /stranded)	4-50 mm ²
Standard	EN 62561-1
PU	25 pc(s)

For earth rods Ø20 mm



Part No.	610 020
Material	StSt (V4A)
Material No.	1.4571 / 1.4404 / 1.4401
ASTM / AISI:	316Ti / 316L / 316
Clamping range Rd / Fl	7-10 / -40 mm
Clamping range (stranded / cable)	35-70 mm ²
Short-circuit current (50 Hz) (1 s; ≤ 300 °C)	8 kA
Standard	EN 62561-1
PU	25 pc(s)

Selection Guide for Hammer Inserts according to their Brand

Brand	Type	Holder	Earth rod		Tubular earth rods	
			Type Z St/tZn (Ø20) Type AZ V4A (Ø20)	Type Z St/tZn (Ø25)	V4A (Ø25)	St/tZn (Ø27)
Wacker Neuson	BH 55	round Ø27 x 80 mm	620 005 620 009	625 005 625 009	648 005	649 005
	BH 65					
	BH 55rw					
	EH 50					
	EH 75					
	EH 22/400					
	EH 23/230					
	EH 24/042/200					
	BH 23					
BHF 30						
Atlas Copco	Cobra 149 (Combi)	hexagon wrench size 22 x 108 mm	620 007	625 007	648 007	649 007
	Cobra 248					
	Pionjär 120					
	Pionjär 130					
	TEX 15 PE	hexagon wrench size 25 x 108 mm	620 008	625 008	-	
	TEX 19 PE					
	TEX 23 PE					
	TEX 15 PE	hexagon wrench size 28 x 160 mm	620 019	625 019	-	
	TEX 19 PE					
	TEX 23 PE					
	TEX 27 H					
	TEX 28 HE					
	TEX 22 PS					
	Cobra TT	hexagon wrench size 32 x 160 mm	620 010	625 010	-	
Cobra PRO						
Chicago Pneumatic	CP Red Hawk Rail	hexagon wrench size 22 x 108 mm	620 007	625 007	648 007	649 007
	CP Red Hawk Road					
	CP Red Hawk Drill					
Milwaukee	K 2500 H	hexagon wrench size 28 mm	620 029	625 029	648 029	649 029
Bosch	GSH 27					
	GSH 27 VC					
Hilti	TE 3000 AVR	TE-S (hexagon wrench size 22 mm)	620 031	625 031	648 031	649 031
	TE 1000 AVR					
	TE 2000 AVR					
Other	Other	SDS-Max (Ø18 x 175 mm)	620 030	625 030	648 009	649 009

Hammer Inserts for Earth Rods

For driving in earth rods with a vibration hammer.
For earth rods type S and Z.
Ø20 mm (pin Ø12 mm Part No. 620...) or
Ø25 mm (pin Ø15 mm Part No. 625...)



With the Atlas Copco equipment different adapter types can be used. Please note that when placing your order.

Design for Wacker Neuson

Part No.	620 005	625 005
Type	BHF 30	BHF 30
Adapter	round Ø27 x 80 mm	round Ø27 x 80 mm
Material	St/bare	St/bare
Hole (d x l)	13 x 50 mm	16 x 55 mm
Length	200 mm	200 mm
Earth rod diameter	20 mm	25 mm
Earth rod type	Z, AZ	S, Z
PU	1 pc(s)	1 pc(s)



Special hammer insert Part No. 620 039 for earth rods Part No. 620 902 TYPE AZ StSt (V4A).

Heavy design for Wacker Neuson



Part No.	620 009	625 009
Type	BH 55, BH 65, BH 55rw, EH 50, EH 75 and EH 22/400	BH 55, BH 65, BH 55rw, EH 50, EH 75 and EH 22/400
Adapter	round Ø27 x 80 mm	round Ø27 x 80 mm
Material	St/bare	St/bare
Hole (d x l)	13 x 50 mm	16 x 55 mm
Length	260 mm	260 mm
Earth rod diameter	20 mm	25 mm
Earth rod type	Z, AZ	Z
PU	1 pc(s)	1 pc(s)

Design for Atlas Copco SW 22



Part No.	620 007	625 007
Type	Cobra Combi, Pionjär 120+130, CP Red Hawk (Cobra Standard)	Cobra Combi, Pionjär 120+130, CP Red Hawk (Cobra Standard)
Adapter	hexagon wrench size 22 x 108 mm	hexagon wrench size 22 x 108 mm
Material	St/bare	St/bare
Hole (d x l)	13 x 50 mm	16 x 55 mm
Length	240 mm	240 mm
Earth rod diameter	20 mm	25 mm
Earth rod type	Z, AZ	Z
PU	1 pc(s)	1 pc(s)

Design for Atlas Copco SW 25



Part No.	620 008	625 008
Type	TEX 15 PE, 19 PE, 23 PE	TEX 15 PE, 19 PE, 23 PE
Adapter	hexagon wrench size 25 x 108 mm	hexagon wrench size 25 x 108 mm
Material	St/bare	St/bare
Hole (d x l)	13 x 50 mm	16 x 55 mm
Length	240 mm	240 mm
Earth rod diameter	20 mm	25 mm
Earth rod type	Z, AZ	Z
PU	1 pc(s)	1 pc(s)

Design for Atlas Copco SW 28



Part No.	620 019	625 019
Type	TEX 28 HE, 27 H, 15 PE, 19 PE, 23 PE, 22 PS	TEX 28 HE, 27 H, 15 PE, 19 PE, 23 PE, 22 PS
Adapter	hexagon wrench size 28 x 160 mm	hexagon wrench size 28 x 160 mm
Material	St/bare	St/bare
Hole (d x l)	13 x 50 mm	16 x 55 mm
Length	350 mm	350 mm
Earth rod diameter	20 mm	25 mm
Earth rod type	Z, AZ	Z
PU	1 pc(s)	1 pc(s)

Design for Atlas Copco SW 32

NEW



Part No.	620 010	625 010 ^{NEW}
Type	TT, PRO, MK1	TT, PRO, MK1
Adapter	hexagon wrench size 32 x 160 mm	hexagon wrench size 32 x 160 mm
Material	St/bare	St/bare
Hole (d x l)	13 x 50 mm	16 x 55 mm
Length	350 mm	350 mm
Earth rod diameter	20 mm	25 mm
Earth rod type	Z, AZ	Z, AZ
PU	1 pc(s)	1 pc(s)

Earth Rods

Design for Bosch / Hilti / Milwaukee

Part No.	620 029	625 029
Type	GSH 27 / TE 3000 AVR / k 2500 h	GSH 27 / TE 3000 AVR / k 2500 h
Adapter	hexagon wrench size 28 (1 1/8")	hexagon wrench size 28 (1 1/8")
Material	St/bare	St/bare
Hole (d x l)	13 x 50 mm	16 x 55 mm
Length	250 mm	250 mm
Earth rod diameter	20 mm	25 mm
Earth rod type	Z, AZ	Z
PU	1 pc(s)	1 pc(s)



Design for Hilti TE-S

Part No.	620 031	625 031
Type	vibration / impact hammer with TE-S adapter	vibration / impact hammer with TE-S adapter
Adapter	hexagon wrench size 22	hexagon wrench size 22
Material	St/bare	St/bare
Hole (d x l)	13 x 50 mm	16 x 55 mm
Length	280 mm	280 mm
Earth rod diameter	20 mm	25 mm
Earth rod type	Z, AZ	Z
PU	1 pc(s)	1 pc(s)



Design for SDS-max

Part No.	620 030	625 030
Type	vibration / impact hammer with SDS-max adapter	vibration / impact hammer with SDS-max adapter
Adapter	round Ø18 x 175 mm	round Ø18 x 175 mm
Material	St/bare	St/bare
Hole (d x l)	13 x 50 mm	16 x 55 mm
Length	260 mm	260 mm
Earth rod diameter	20 mm	25 mm
Earth rod type	Z, AZ	Z
PU	1 pc(s)	1 pc(s)



Note: It is recommended to use a hammer with a minimum striking force of 26 joules. The maximum drive-in depth depends on the soil conditions.

Designs for other types of hammer available on request.

Hammer Inserts for Tubular Earth Rods

For driving in tubular earth rods with a vibration hammer.



Design Wacker Neuson

Part No.	648 005	649 005
Type	EH 22/400, EH 23/230, EH 24/042/200, BH 23 and BHF 30	EH 22/400, EH 23/230, EH 24/042/200, BH 23 and BHF 30
Adapter	round Ø27 x 80 mm	round Ø27 x 80 mm
Material	St/bare	St/bare
Hole (d x l)	25.6 x 39 mm	29 x 39 mm
Length	246 mm	246 mm
Earth rod diameter	25 mm	27 mm
Earth rod type	RE	RE
PU	1 pc(s)	1 pc(s)



Design Atlas Copco

Part No.	648 007	649 007
Type	Cobra 149+248 and Pionjär 120+130	Cobra 149+248 and Pionjär 120+130
Adapter	hexagon wrench size 22 x 108 mm	hexagon wrench size 22 x 108 mm
Material	St/bare	St/bare
Hole (d x l)	25.6 x 39 mm	29 x 39 mm
Length	246 mm	246 mm
Earth rod diameter	25 mm	27 mm
Earth rod type	RE	RE
PU	1 pc(s)	1 pc(s)



Design SDS-max



Part No.	648 009	649 009
Type	vibration / impact hammer with SDS-max adapter	vibration / impact hammer with SDS-max adapter
Adapter	round Ø18 x 175 mm	round Ø18 x 175 mm
Material	St/bare	St/bare
Hole (d x l)	25.6 x 39 mm	29 x 39 mm
Length	260 mm	260 mm
Earth rod diameter	25 mm	27 mm
Earth rod type	RE	RE
PU	1 pc(s)	1 pc(s)

Note: It is recommended to use a hammer with a minimum striking force of 26 joules. The maximum drive-in depth depends on the soil conditions.

Design Bosch / Hilti / Milwaukee

NEW



Part No.	648 029 ^{NEW}	649 029 ^{NEW}
Type	GSH 27, GSH 27 VC, TE 3000 AVR	GSH 27, GSH 27 VC, TE 3000 AVR
Adapter	hexagon wrench size 28	hexagon wrench size 28
Material	St/bare	St/bare
Hole (d x l)	25.6 x 39 mm	29 x 39 mm
Length	266 mm	266 mm
Earth rod diameter	25 mm	27 mm
Earth rod type	RE	RE
PU	1 pc(s)	1 pc(s)

Design Hilti TE-S

NEW



Part No.	648 031 ^{NEW}	649 031 ^{NEW}
Type	vibration / impact hammer with TE-S adapter	vibration / impact hammer with TE-S adapter
Adapter	Hilti TE-S	Hilti TE-S
Material	St/bare	St/bare
Hole (d x l)	25,6 x 39 mm	30.9 x 39 mm
Length	280 mm	280 mm
Earth rod diameter	25 mm	27 mm
Earth rod type	RE	RE
PU	1 pc(s)	1 pc(s)

Designs for other types of hammer available on request.

Driving Heads

For driving in earth rods with a mallet.



Part No.	620 002	625 002
Type of earth rod	types Z + AZ (Ø20 mm)	type Z (Ø25 mm)
Material	St/bare	St/bare
PU	1 pc(s)	1 pc(s)

Hammer Frame

For driving earth rods of 1000 mm or 1500 mm in length into the ground using a vibration hammer.

The hammer frame is delivered with a hammer slide guide.

Part No.	600 003
Material	St/tZn
Height	2550 mm
PU	1 pc(s)



Hammer Support

For vibration hammers of the following brands

Design for Wacker Neuson

Part No.	600 035
Types	EH 23 Low Vib, EH 22/400, EH 25, BH 24 Low Vib, BH 23, BHF 30, BH 55, BH 65, BH 55 rw, EH 50, EH 75
Material	St/tZn
PU	1 pc(s)



Design for Atlas Copco

Part No.	600 029
Types	Cobra Combi, CP Red Hawk (Cobra Standard)
Material	St/tZn
PU	1 pc(s)



Design for Bosch

Part No.	600 050
Types	GSH 27
Material	St/tZn
PU	1 pc(s)





DEHN protects.

Earthing Cables with open Cable Lugs

Highly flexible copper conductor, frost-resistant, UV-stabilised.
Packing in accordance with VG 96927-11.

Cable lug, 2x open, 2x M8 / M10

General technical data:				
Cable cross section	10 mm ²			
Cable lug open	2x M8 / M10			
Colour	black ●			
Part No.	410 003	410 005	410 006	410 010
Cable length	0.35 m	0.55 m	0.65 m	1.05 m
Military Name	VG 96927 T011 A044	VG 96927 T011 A045	VG 96927 T011 A046	VG 96927 T011 A047
Stock No.	6150-12-156-9107	6150-12-156-8386	6150-12-156-9108	6150-12-156-8387
PU	1 pc(s)	1 pc(s)	1 pc(s)	1 pc(s)
Part No.	410 015	410 020	410 025	410 030
Cable length	1.55 m	2.05 m	2.55 m	3.05 m
Military Name	VG 96927 T011 A048	VG 96927 T011 A049	VG 96927 T011 A050	VG 96927 T011 A051
Stock No.	6150-12-156-9069	6150-12-156-9073	6150-12-156-9072	6150-12-156-9109
PU	1 pc(s)	1 pc(s)	1 pc(s)	1 pc(s)
Part No.	410 035	410 040	410 050	410 060
Cable length	3.55 m	4.05 m	5.05 m	6.05 m
Military Name	VG 96927 T011 A052	VG 96927 T011 A053	VG 96927 T011 A054	VG 96927 T011 A055
Stock No.	6150-12-156-9071	6150-12-156-9070	6150-12-156-6051	6150-12-156-9110
PU	1 pc(s)	1 pc(s)	1 pc(s)	1 pc(s)
Part No.	410 070	410 099	410 140	
Cable length	7.05 m	10.0 m	14.0 m	
Military Name	VG 96927 T011 A056	VG 96927 T011 A057	VG 96927 T011 A058	
Stock No.	6150-12-156-9111	6150-12-156-9112	6150-12-156-6207	
PU	1 pc(s)	1 pc(s)	1 pc(s)	
Part No.	410 150	410 199	410 299	
Cable length	15.0 m	20.0 m	30.0 m	
Military Name	VG 96927 T011 A059	VG 96927 T011 A060	VG 96927 T011 A061	
Stock No.	6150-12-161-4272	6150-12-156-9113	6150-12-156-9114	
PU	1 pc(s)	1 pc(s)	1 pc(s)	



Cable lug, 2x open, 1x M8 / M10 and 1x M5 / M6

General technical data:				
Cable cross section	10 mm ²			
Cable lug open	1x M8 / M10 1x M5 / M6			
Colour	black ●			
Part No.	410 603	410 605	410 610	410 615
Cable length	0.35 m	0.55 m	1.05 m	1.55 m
Military Name	—	—	—	VG 96927 T011 A123
Stock No.	—	—	—	6150-12-308-6928
PU	1 pc(s)	1 pc(s)	1 pc(s)	1 pc(s)
Part No.	410 620	410 625	410 630	
Cable length	2.05 m	2.55 m	3.05 m	
Military Name	—	—	—	
Stock No.	—	—	6150-12-353-5887	
PU	1 pc(s)	1 pc(s)	1 pc(s)	



Cable lug, 2x open, 2x M8 / M10

General technical data:	
Cable cross section	16 mm ²
Cable lug open	2x M8 / M10
Colour	black ●

Part No.	416 003	416 005	416 006	416 010
Cable length	0.35 m	0.55 m	0.65 m	1.05 m
Military Name	VG 96927 T011 A062	VG 96927 T011 A063	VG 96927 T011 A064	VG 96927 T011 A065
Stock No.	6150-12-156-9115	6150-12-156-9085	6150-12-156-9116	6150-12-156-9084
PU	1 pc(s)	1 pc(s)	1 pc(s)	1 pc(s)

Part No.	416 015	416 020	416 025	416 030
Cable length	1.55 m	2.05 m	2.55 m	3.05 m
Military Name	VG 96927 T011 A066	VG 96927 T011 A067	VG 96927 T011 A068	VG 96927 T011 A069
Stock No.	6150-12-156-9117	6150-12-156-9118	6150-12-156-9119	6150-12-156-9083
PU	1 pc(s)	1 pc(s)	1 pc(s)	1 pc(s)

Part No.	416 035	416 040	416 050	416 060
Cable length	3.55 m	4.05 m	5.05 m	6.05 m
Military Name	VG 96927 T011 A070	VG 96927 T011 A071	VG 96927 T011 A072	VG 96927 T011 A073
Stock No.	6150-12-156-6208	6150-12-156-8388	6150-12-156-9120	6150-12-156-9082
PU	1 pc(s)	1 pc(s)	1 pc(s)	1 pc(s)

Part No.	416 070	416 080	416 100	416 120
Cable length	7.05 m	8.05 m	10.05 m	12.05 m
Military Name	VG 96927 T011 A074	VG 96927 T011 A075	VG 96927 T011 A076	VG 96927 T011 A077
Stock No.	6150-12-156-9121	6150-12-188-4475	6150-12-156-9122	6150-12-188-4476
PU	1 pc(s)	1 pc(s)	1 pc(s)	1 pc(s)

Part No.	416 140	416 150	416 200
Cable length	14.05 m	15.05 m	20.05 m
Military Name	VG 96927 T011 A078	VG 96927 T011 A079	VG 96927 T011 A080
Stock No.	6150-12-156-9123	6150-12-161-4273	6150-12-156-9124
PU	1 pc(s)	1 pc(s)	1 pc(s)

Part No.	416 220	416 280	416 300
Cable length	22.05 m	28.05 m	30.05 m
Military Name	VG 96927 T011 A081	VG 96927 T011 A082	VG 96927 T011 A083
Stock No.	6150-12-188-4477	6150-12-188-4478	6150-12-156-9125
PU	1 pc(s)	1 pc(s)	1 pc(s)



Cable lug, 2x open, 1x M8 / M10 and 1x M5 / M6

Part No.	416 516
Cable cross section	16 mm ²
Cable length	1.55 m
Cable lug open	1x M8 / M10 1x M5 / M6
Colour	black ●
Military Name	VG 96927 T011 A125
Stock No.	6150-12-308-6607
PU	1 pc(s)



Earthing Material for Telecommunications

Cable lug, 2x open, 2x M8 / M10 green / yellow

Highly flexible copper conductor (ESY), frost-proof.

General technical data:				
Cable cross section	16 mm ²			
Cable lug open	2x M8 / M10			
Colour	green ● / yellow ●			
Part No.	417 005	417 010	417 015	417 020
Cable length	0.55 m	1.05 m	1.55 m	2.05 m
Stock No.	6150-12-313-5059	6150-12-313-5060	6150-12-313-5061	6150-12-313-5062
PU	1 pc(s)	1 pc(s)	1 pc(s)	1 pc(s)
Part No.	417 030	417 050	417 100	417 115
Cable length	3.05 m	5.05 m	10.05 m	15.05 m
Stock No.	6150-12-313-5063	6150-12-313-5064	6150-12-313-5065	6150-12-313-5066
PU	1 pc(s)	1 pc(s)	1 pc(s)	1 pc(s)
Part No.	417 120	417 125	417 130	417 150
Cable length	20.05 m	25.05 m	30.05 m	50.05 m
Stock No.	6150-12-313-5067	6150-12-185-8587	6150-12-313-5068	6150-12-174-2744
PU	1 pc(s)	1 pc(s)	1 pc(s)	1 pc(s)

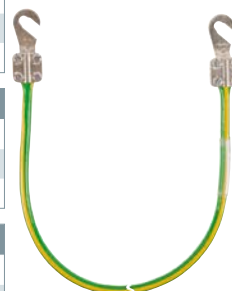

Packing in accordance with specifications of the VG standards (defence equipment standards) must be explicitly indicated when ordering.

Earthing Cables with open / closed Cable Lugs

Highly flexible copper cable, frost-resistant, UV-stabilised.

Packing in accordance with VG 96927-11.

Cable lug, 1x open M5 / M6 and 1x closed M8

General technical data:				
Cable cross section	10 mm ²			
Cable lug open	M5 / M6			
Cable lug closed	M8			
Hole Ø	8.5 mm			
Colour	black ●			
Part No.	410 503	410 506	410 510	410 515
Cable length	0.35 m	0.65 m	1.05 m	1.55 m
Military Name	VG 96927 T011 A116	VG 96927 T011 A117	VG 96927 T011 A118	VG 96927 T011 A119
Stock No.	6150-12-196-7302	6150-12-195-9694	6150-12-196-7304	6150-12-196-7303
PU	1 pc(s)	1 pc(s)	1 pc(s)	1 pc(s)
Part No.	410 520	410 525	410 530	
Cable length	2.05 m	2.55 m	3.05 m	
Military Name	VG 96927 T011 A120	VG 96927 T011 A121	VG 96927 T011 A122	
Stock No.	6150-12-196-7606	6150-12-198-6807	6150-12-198-6808	
PU	1 pc(s)	1 pc(s)	1 pc(s)	

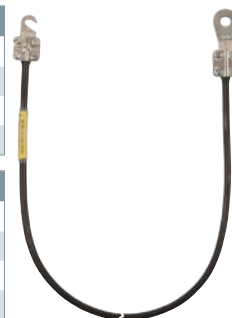

Cable lug, 1x open M8 / M10 and 1x closed M8

General technical data:	
Cable cross section	10 mm ²
Cable lug open	M8 / M10
Cable lug closed	M8
Hole Ø	8.5 mm
Colour	black ●

Part No.	410 401	410 403	410 404	410 450
Cable length	0.20 m	0.35 m	0.45 m	0.55 m
Military Name	VG 96927 T011 A092	VG 96927 T011 A093	VG 96927 T011 A094	VG 96927 T011 A095
Stock No.	6150-12-300-9132	6150-12-195-9490	6150-12-192-5455	6150-12-197-0088
PU	1 pc(s)	1 pc(s)	1 pc(s)	1 pc(s)

Part No.	410 406	410 411	410 415
Cable length	0.65 m	1.05 m	1.55 m
Military Name	VG 96927 T011 A096	VG 96927 T011 A097	VG 96927 T011 A098
Stock No.	6150-12-192-5456	6150-12-192-5457	6150-12-192-5458
PU	1 pc(s)	1 pc(s)	1 pc(s)

Part No.	410 420	410 425	410 430
Cable length	2.05 m	2.55 m	3.05 m
Military Name	VG 96927 T011 A099	VG 96927 T011 A100	VG 96927 T011 A101
Stock No.	6150-12-198-1217	6150-12-198-6803	6150-12-198-6805
PU	1 pc(s)	1 pc(s)	1 pc(s)



Cable lug, 1x open M8 / M10 and 1x closed M10

General technical data:	
Cable cross section	10 mm ²
Cable lug open	M8 / M10
Cable lug closed	M10
Hole Ø	10.5 mm
Colour	black ●

Part No.	410 413	410 405	410 407	410 410
Cable length	0.35 m	0.55 m	0.65 m	1.05 m
Military Name	VG 96927 T011 A084	VG 96927 T011 A085	VG 96927 T011 A086	VG 96927 T011 A087
Stock No.	6150-12-196-7301	6150-12-196-6346	6150-12-198-7027	6150-12-171-2783
PU	1 pc(s)	1 pc(s)	1 pc(s)	1 pc(s)

Part No.	410 416	410 421	410 426	410 431
Cable length	1.55 m	2.05 m	2.55 m	3.05 m
Military Name	VG 96927 T011 A088	VG 96927 T011 A089	VG 96927 T011 A090	VG 96927 T011 A091
Stock No.	6150-12-198-1216	6150-12-198-1218	6150-12-198-6804	6150-12-198-6806
PU	1 pc(s)	1 pc(s)	1 pc(s)	1 pc(s)



Cable lug, 1x open M5 / M6 and 1x closed M8

Part No.	416 505
Cable cross section	16 mm ²
Cable length	0.55 m
Cable lug open	M5 / M6
Cable lug closed	M8
Hole Ø	8.5 mm
Colour	black ●
Military Name	VG 96927 T011 A124
Stock No.	6150-12-300-9131
PU	1 pc(s)



Cable lug, 1x open M8 / M10 and 1x closed M8

General technical data:				
Cable cross section	16 mm ²			
Cable lug open	M8 / M10			
Cable lug closed	M8			
Hole Ø	8.5 mm			
Colour	black ●			
Part No.	416 411	416 415	416 420	416 425
Cable length	1.05 m	1.55 m	2.05 m	2.55 m
Military Name	VG 96927 T011 A109	VG 96927 T011 A110	VG 96927 T011 A111	VG 96927 T011 A112
Stock No.	6150-12-308-6934	6150-12-308-6981	6150-12-308-6933	6150-12-308-6932
PU	1 pc(s)	1 pc(s)	1 pc(s)	1 pc(s)
Part No.	416 430	416 440	416 450	
Cable length	3.05 m	4.05 m	5.05 m	
Military Name	VG 96927 T011 A113	VG 96927 T011 A114	VG 96927 T011 A115	
Stock No.	6150-12-308-6931	6150-12-308-6930	6150-12-308-6929	
PU	1 pc(s)	1 pc(s)	1 pc(s)	



Cable lug, 1x open M8 / M10 and 1x closed M10

General technical data:				
Cable cross section	16 mm ²			
Cable lug open	M8 / M10			
Cable lug closed	M10			
Hole Ø	10.5 mm			
Colour	black ●			
Part No.	416 403	416 410	416 416	416 421
Cable length	0.35 m	1.05 m	1.55 m	2.05 m
Military Name	—	VG 96927 T011 A102	VG 96927 T011 A103	VG 96927 T011 A104
Stock No.	—	6150-12-308-6941	6150-12-308-6940	6150-12-308-6939
PU	1 pc(s)	1 pc(s)	1 pc(s)	1 pc(s)
Part No.	416 426	416 431	416 441	416 451
Cable length	2.55 m	3.05 m	4.05 m	5.05 m
Military Name	VG 96927 T011 A105	VG 96927 T011 A106	VG 96927 T011 A107	VG 96927 T011 A108
Stock No.	6150-12-309-6938	6150-12-308-6937	6150-12-308-6936	6150-12-308-6935
PU	1 pc(s)	1 pc(s)	1 pc(s)	1 pc(s)



Packing in accordance with specifications of the VG standards (defence equipment standards) must be explicitly indicated when ordering.

Earthing Cables with closed Cable Lugs

Highly flexible copper cable, frost-resistant, UV-stabilised. Packing in accordance with VG 96927-11.

Cable lug, 2x closed M10

General technical data:				
Cable cross section	10 mm ²			
Cable lug closed	2x M10			
Hole Ø	10.5 mm			
Colour	black ●			
Part No.	410 903	410 905	410 906	410 910
Cable length	0.35 m	0.55 m	0.65 m	1.05 m
Military Name	VG 96927 T011 A027	VG 96927 T011 A028	VG 96927 T011 A029	VG 96927 T011 A030
Stock No.	6150-12-198-1948	6150-12-198-6809	6150-12-198-6810	6150-12-198-1482
PU	1 pc(s)	1 pc(s)	1 pc(s)	1 pc(s)
Part No.	410 915	410 920	410 925	410 930
Cable length	1.55 m	2.05 m	2.55 m	3.05 m
Military Name	VG 96927 T011 A031	VG 96927 T011 A032	VG 96927 T011 A033	VG 96927 T011 A034
Stock No.	6150-12-168-2696	6150-12-168-2695	6150-12-168-2694	—
PU	1 pc(s)	1 pc(s)	1 pc(s)	1 pc(s)

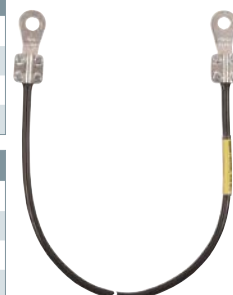

Cable lug, 2x closed M10



General technical data:	
Cable cross section	16 mm ²
Cable lug closed	2x M10
Hole Ø	10.5 mm
Colour	black ●

Part No.	416 903	416 905	416 906
Cable length	0.35 m	0.55 m	0.65 m
Military Name	VG 96927 T011 A035	VG 96927 T011 A036	VG 96927 T011 A037
Stock No.	6150-12-198-6812	6150-12-198-6813	6150-12-198-6814
PU	1 pc(s)	1 pc(s)	1 pc(s)

Part No.	416 910	416 915	416 920
Cable length	1.05 m	1.55 m	2.05 m
Military Name	VG 96927 T011 A038	VG 96927 T011 A039	VG 96927 T011 A040
Stock No.	6150-12-168-9942	6150-12-168-2693	6150-12-198-6815
PU	1 pc(s)	1 pc(s)	1 pc(s)

Part No.	416 925	416 930	416 970
Cable length	2.55 m	3.05 m	7.05 m
Military Name	VG 96927 T011 A041	VG 96927 T011 A042	VG 96927 T011 A043
Stock No.	6150-12-198-6816	6150-12-198-1483	6150-12-168-2692
PU	1 pc(s)	1 pc(s)	1 pc(s)

Packing in accordance with specifications of the VG standards (defence equipment standards) must be explicitly indicated when ordering.

Earthing Cables with Cable Lug / Pin Cable Lug

Made of highly flexible copper conductor, frost-resistant, UV-stabilised.
Packing in accordance with VG 96927-11.



Cable lug, 1x open and pin cable lug size 10

Part No.	410 720
Cable cross section	10 mm ²
Cable length	2.05 m
Cable lug open	M8 / M10
Pin cable lug	size 10 (w = 4.3)
Colour	black ●
Military Name	VG 96927 T011 A127
Stock No.	6150-12-308-6979
PU	1 pc(s)



Cable lug, 1x open and pin cable lug size 16

Part No.	416 016
Cable cross section	16 mm ²
Cable length	1.55 m
Cable lug open	M8 / M10
Pin cable lug	size 16 (w = 5.8)
Colour	black ●
Military Name	VG 96927 T011 A128
Stock No.	6150-12-178-9673
PU	1 pc(s)



Cable lug, 1x closed and pin cable lug size 10

Part No.	410 606
Cable cross section	10 mm ²
Cable length	0.65 m
Cable lug closed	M8
Pin cable lug	size 10 (w = 4.3)
Colour	black ●
Military Name	VG 96927 T011 A126
Stock No.	6150-12-304-4604
PU	1 pc(s)

Packing in accordance with specifications of the VG standards (defence equipment standards) must be explicitly indicated when ordering.

Earthing Cable Lugs

For mounting on site with integrated strain relief (second half of clamping part).

Please observe the following parameters for mounting:

- Stripping approx. 15 mm
- Wire end ferrule acc. to DIN 46228
- Tightening torque of the locking nut screws ≥ 3 Nm

Open M5 / M6

Part No.	444 006
Cable cross section	6-16 mm ²
Cable lug fitting	M5 / M6
Material	Cu/gal Sn
Military Name	VG 96933 T14 A002A
Stock No.	5940-12-156-9126
PU	100 pc(s)



Open M8 / M10

Part No.	444 010
Cable cross section	6-16 mm ²
Cable lug fitting	M8 / M10
Material	Cu/gal Sn
Military Name	VG 96933 T14 A001A
Stock No.	5940-12-152-3867
PU	100 pc(s)



Closed M8

Part No.	444 008
Cable cross section	6-16 mm ²
Cable lug fitting	M8
Material	Cu/gal Sn
Military Name	VG 96933 T14 B001A
Stock No.	5940-12-156-9128
PU	1 pc(s)



Closed M10

Part No.	444 009
Cable cross section	6-16 mm ²
Cable lug fitting	M10
Material	Cu/gal Sn
Military Name	VG 96933 T14 B002A
Stock No.	5940-12-156-9127
PU	1 pc(s)



Packing in accordance with specifications of the VG standards (defence equipment standards) must be explicitly indicated when ordering.

Earthing Clamps

For connecting earthing conductors to pipes.

Small design

Part No.	435 805
Material of clamping body	MCl/tZn
Material of spindle	St/gal Zn
Clamping range pipe Ø	4-45 mm (3/8-1 1/4")
Connection cross-section	6-16 mm ²
Military Name	VG 96953 T06 A0001
Stock No.	5999-12-156-9129
PU	1 pc(s)





Large design

Part No.	435 803
Material of clamping body	MCl/tZn
Material of spindle	St/gal Zn
Clamping range pipe Ø	12-60 mm (1/2-2")
Connection cross-section	6-16 mm ²
Military Name	VG 96953 T06 B0001
Stock No.	5999-12-156-2656
PU	1 pc(s)

Packing in accordance with specifications of the VG standards (defence equipment standards) must be explicitly indicated when ordering.

Antenna Earthing - Telecommunication Systems

Pipe clamp for lightning equipotential bonding of pipes (e.g. antenna poles) according to IEC/EN 62305-3. With gradually adjustable tensioning strap, for connecting one or two conductors and suitable for through-wiring.



Antenna pipe clamps complete

Connection of:

1 conductor Rd Ø10 mm or 1-2 conductors Rd Ø6-8 mm or 4-50 mm² (solid / stranded).



Part No.	540 103	540 100
Material	StSt	StSt
Clamping range pipe Ø	16-89 mm (3/8-3")	16-168 mm (3/8-6")
Screw	☒ M8 x 20 mm	☒ M8 x 20 mm
Material of screw	StSt	StSt
Dimensions of strap (l1 x w x d)	330 x 25 x 0.3 mm	570 x 25 x 0.3 mm
Standard	EN 62561-1	EN 62561-1
Military Name	VG 96953 T05 B0001	VG 96953 T05 B0002
Stock No.	—	5975-12-120-7744
PU	10 pc(s)	10 pc(s)

Separate clamping head

For combination with endless tensioning strap (Part No. 540 901).

Connection of 1 conductor Rd Ø10 mm or 1-2 conductors Rd Ø6-8 mm or 4-50 mm² (solid / stranded).



Part No.	540 110
Material	StSt
Screw	☒ M8 x 20 mm
Material of screw	StSt
Standard	EN 62561-1
Military Name	VG 96953 T05 BA001
PU	50 pc(s)

Endless tensioning strap

For cutting to length, e.g. with snips.



Part No.	540 901
Material	StSt
Dimensions of strap (w x d)	25 x 0.3 mm
Military Name	VG 96953 T05 BB001
PU	1 pc(s)

Earthing Busbars

With slot and anti-rotation protection, for fixing to the earthing pipe.

Three-pole design

Part No.	465 801
Material of busbar	St/tZn
Length	181 mm
Screw	☒ M10 x 35 mm
Military Name	VG 96953 T07 A0001
Stock No.	5940-12-156-8385
PU	1 pc(s)



Five-pole design

Part No.	466 192
Material of busbar	St/tZn
Length	290 mm
Screw	☒ M10 x 35 mm
Military Name	VG 96953 T07 B0001
Stock No.	5940-12-188-4931
PU	1 pc(s)



Packing in accordance with specifications of the VG standards (defence equipment standards) must be explicitly indicated when ordering.

Earthing Spikes

For earthing mobile objects such as vehicles, power generators, etc.

Part No.	634 145	634 160
Material of profile	St/tZn	St/tZn
Profile	50 x 50 x 3 mm	50 x 50 x 3 mm
Length	450 mm	600 mm
Screw	☒ M8 x 40 mm	☒ M8 x 40 mm
Nut	wing nut M8	wing nut M8
Military Name	VG 96953 T10 D0003	VG 96953 T10 D0004
Stock No.	5975-12-382-6412	—
PU	1 pc(s)	1 pc(s)



Anchoring Pole

For guying rod sections and batten shears e.g. when traversing telecommunication cables.

Part No.	466 203
Material of profile	MCl/tZn
Profile	25 x 25 x 3.6 mm
Length	405 mm
Design	hole Ø28 mm
Military Name	VG 96953 T10 E0001
Stock No.	4030-12-320-9037
PU	1 pc(s)



Earthing Pipe with Drilling Spiral

For earthing mobile objects such as vehicles, power generators, etc. Detachable turning handle.

Consisting of:

- Turning handle (Part No. 462 058, military name VG 96953 T10 AB001, stock No. 5975-12-133-7084)
- Earthing pipe (Part No. 462 060, military name VG 96953 T10 AA001, stock No. 5975-12-133-7271)
- Clamping body with knurled screw (Part No. 644 099, military name VG 96953 T10 AC001, stock No. 5975-12-399-5493)

Part No.	644 000
Material	St/tZn
Length	1000 mm
Screw	☒ M10 x 35 mm
Military Name	VG 96953 T10 A0001
Stock No.	5975-12-120-0006
PU	1 pc(s)



DEHN protects.



Equipotential Bonding Busbars K12 with Snap-on Terminals

Equipotential bonding busbars for protective and functional equipotential bonding according to IEC 60364-4-41/60364-5-54 and lightning equipotential bonding according to IEC/EN 62305-3.

- Tested according to DIN VDE 0618-1
- VDE sign
- CE sign
- Fixing frames and plastic cover, grey or black (halogen-free)
- Sealable / labelable cover
- Snap-on terminals, St/gal Zn
- With 12 contact studs

Assignment:

For Rd one contact stud each. For FI two contact studs each.

Standard design

Terminals for:

10 conductors 2.5-95 mm² (solid / stranded) or Rd Ø10 mm

1 conductor FI up to 30 x 4 mm.

Part No.	563 200
Material of contact rail	Cu/gal Sn
Cross section	30 mm ²
Fixing	[2x] 6 x 8 mm
Standard	EN 62561-1
PU	1 pc(s)



UV-stabilised design

Terminals for:

10 conductors 2.5-95 mm² (solid / stranded) or Rd Ø10 mm.

1 conductor FI up to 30 x 4 mm.

Part No.	563 201
Material of contact rail	Cu/gal Sn
Cross section	30 mm ²
Fixing	[2x] 6 x 8 mm
Standard	EN 62561-1
PU	1 pc(s)



Equipotential Bonding Busbar MS

For equipotential bonding.

Terminals for:

7 conductors 2.5-25 mm² (solid / stranded).

1 conductor Rd Ø7-10 mm.

1 conductor FI up to 30 x 3.5 mm or Rd Ø8-10 mm.

Part No.	563 050
Contact rail	brass
Cross section	35 mm ²
Fixing	[4x] 6 x 9 mm
PU	1 pc(s)



Equipotential Bonding Busbar with Miniature Terminal Block System

Equipotential bonding busbars for protective and functional equipotential bonding according to IEC 60364-4-41/60364-5-54 in small installations.

- Tested according to DIN EN 60999-2
- Terminal block, St/gal Zn

Without cover.

Terminals for: 6 conductors 2.5-25 mm² (solid / stranded).

Part No.	563 105
Clamping bar	brass/gal Sn
Cross section	100 mm ²
Bar frames	plastic
Fixing	[4x] 6 x 12 mm
Standard	EN 62561-1
PU	10 pc(s)



Equipotential Bonding Busbars R15 with Terminal Block System / Kit

Equipotential bonding busbars for protective and functional equipotential bonding according to IEC 60364-4-41/60364-5-54 and lightning equipotential bonding according to IEC/EN 62305-3.

- Tested according to DIN VDE 0609
- 15 modules
- Grey plastic bar frames and cover (halogen-free)
- Sealable / labelable cover
- Terminal block, St/gal Zn

Type A

Terminals for:

7 conductors 2.5-25 mm² (solid / stranded).

2 conductors 16-95 mm² (solid / stranded) or Rd Ø8-10 mm.

1 conductor FI up to 30 x 4 mm.



Part No.	563 010
Clamping bar	brass/gal Sn
Cross section	100 mm ²
Fixing	[4x] 6 x 12 mm
Standard	EN 62561-1
PU	1 pc(s)

Type B

Terminals for:

5 conductors 2.5-25 mm² (solid / stranded).

3 conductors 16-95 mm² (solid / stranded) or Rd Ø8-10 mm.

1 conductor FI up to 30 x 4 mm.



Part No.	563 020
Clamping bar	brass/gal Sn
Cross section	100 mm ²
Fixing	[4x] 6 x 12 mm
Standard	EN 62561-1
PU	1 pc(s)

Type C

Terminals for:

13 conductors 2.5-25 mm² (solid / stranded).

1 conductor 16-95 mm² (solid / stranded) or Rd Ø8-10 mm.



Part No.	563 030
Clamping bar	brass/gal Sn
Cross section	100 mm ²
Fixing	[4x] 6 x 12 mm
Standard	EN 62561-1
PU	1 pc(s)

Type D

Terminals for:

7 conductors 2.5-25 mm² (solid / stranded).

2 conductors 16-95 mm² (solid / stranded) or Rd Ø8-10 mm.

1 conductor FI up to 40 x 5 mm.



Part No.	563 040
Clamping bar	brass/gal Sn
Cross section	100 mm ²
Fixing	[4x] 6 x 12 mm
Standard	EN 62561-1
PU	1 pc(s)

Accessory for Equipotential Bonding Busbars R15 with Terminal Block System / Kit

Cover

Snap-on / can be labelled



Part No.	563 015
Material	plastic
Colour	grey ●
Modules	15
PU	10 pc(s)

Terminal block

Connection of:
1 conductor 2.5-25 mm² (solid / stranded).

Part No.	563 011
Material	St/gal Zn
Modules	1
Standard	EN 62561-1
PU	200 pc(s)



Terminal block

Connection of:
1 conductor 16-95 mm² (solid / stranded) or Rd Ø8-10 mm.

Part No.	563 013
Material	St/gal Zn
Modules	2
Standard	EN 62561-1
PU	100 pc(s)



Terminal block

Connection of:
1 conductor Fl up to 30 x 4 mm.

Part No.	563 012
Material	St/gal Zn
Modules	4
Standard	EN 62561-1
PU	1 pc(s)



Terminal block

Connection of:
1 conductor Fl up to 40 x 5 mm.

Part No.	563 019
Material	St/gal Zn
Modules	5
Standard	EN 62561-1
PU	1 pc(s)



Clamping bar

Part No.	563 016	563 017	563 018
Length	198 mm	398 mm	798 mm
Modules	15	30	60
Material	brass/gal Sn	brass/gal Sn	brass/gal Sn
Cross section	100 mm ²	100 mm ²	100 mm ²
Number of bar frames	2	4	8
Number of covers	1	2	4
PU	10 pc(s)	10 pc(s)	1 pc(s)



Bar frame

Part No.	563 014
Material	plastic
Colour	grey ●
Fixing	[2x] 6 x 12 mm
Modules	2
PU	50 pc(s)

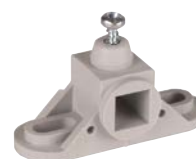



Equipotential Bonding Busbars Industry

Equipotential bonding busbars for protective and functional equipotential bonding according to IEC 60364-4-41/60364-5-54 and lightning equipotential bonding according to IEC/EN 62305-3.

Also for use in potentially explosive atmospheres (secured against self-loosening of screws).



- With spring washer
- Insulator UP (duroplastic, red) with M10 thread
- UV-stabilised and halogen-free

6 terminals

Part No.	472 207	472 209
Material	Cu	StSt
Dimensions (l x w x d)	295 x 40 x 5 mm	295 x 40 x 6 mm
Cross-section	200 mm ²	240 mm ²
Short-circuit current (50 Hz) (1 s; ≤ 300 °C)	39 kA	8.9 kA
Screw	 M10 x 25 mm	 M10 x 25 mm
Material of screw / nut	StSt	StSt
Design	with spring washer	with spring washer
Material of insulator	UP	UP
Standard	EN 62561-1	EN 62561-1
PU	1 pc(s)	1 pc(s)



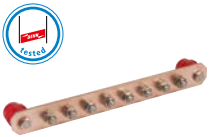

8 terminals

Part No.	472 227	472 229
Material	Cu	StSt
Dimensions (l x w x d)	365 x 40 x 5 mm	365 x 40 x 6 mm
Cross-section	200 mm ²	240 mm ²
Short-circuit current (50 Hz) (1 s; ≤ 300 °C)	39 kA	8.9 kA
Screw	 M10 x 25 mm	 M10 x 25 mm
Material of screw / nut	StSt	StSt
Design	with spring washer	with spring washer
Material of insulator	UP	UP
Standard	EN 62561-1	EN 62561-1
PU	1 pc(s)	1 pc(s)





10 terminals

Part No.	472 217	472 219
Material	Cu	StSt
Dimensions (l x w x d)	435 x 40 x 5 mm	435 x 40 x 6 mm
Cross-section	200 mm ²	240 mm ²
Short-circuit current (50 Hz) (1 s; ≤ 300 °C)	39 kA	8.9 kA
Screw	 M10 x 25 mm	 M10 x 25 mm
Material of screw / nut	StSt	StSt
Design	with spring washer	with spring washer
Material of insulator	UP	UP
Standard	EN 62561-1	EN 62561-1
PU	1 pc(s)	1 pc(s)



12 terminals

Part No.	472 237	472 239
Material	Cu	StSt
Dimensions (l x w x d)	505 x 40 x 5 mm	505 x 40 x 6 mm
Cross-section	200 mm ²	240 mm ²
Short-circuit current (50 Hz) (1 s; ≤ 300 °C)	39 kA	8.9 kA
Screw	 M10 x 25 mm	 M10 x 25 mm
Material of screw / nut	StSt	StSt
Design	with spring washer	with spring washer
Material of insulator	UP	UP
Standard	EN 62561-1	EN 62561-1
PU	1 pc(s)	1 pc(s)



Special designs available on request.

Equipotential Bonding

Accessory for Equipotential Bonding Busbars Industry

Cover for EBB industry

Covers for EBB with insulators.

Part No.	472 279	472 269	472 289	472 299
Type of EBB	6 terminals	8 terminals	10 terminals	12 terminals
Dimensions (l x w x d)	301 x 60 x 0.8 mm	371 x 60 x 0.8 mm	441 x 60 x 0.8 mm	511 x 60 x 0.8 mm
Material	StSt	StSt	StSt	StSt
PU	1 pc(s)	1 pc(s)	1 pc(s)	1 pc(s)



Insulator for EBB industry

Part No.	472 210
Material	UP (thermoset)
Connection thread	M10 (length 12 mm)
Colour	red ●
Dimensions (d x h)	32 x 40 mm
PU	1 pc(s)



Fixing kit for EBB industry

For mounting the insulators, e.g. on walls.

Part No.	472 201	472 202
Material of screw	St/tZn	StSt
Screw	45 mm ∇ M10 x 20 mm	45 mm ∇ M10 x 20 mm
Plastic dowel	Ø12 x 60 mm	Ø12 x 60 mm
Total length	80 mm	80 mm
PU	1 pc(s)	1 pc(s)



Single-Row Earthing Busbars

Earthing busbars for screwing on steel constructions, hole spacing 35 mm.

Connection possibilities:

- Flat strip with bore: with M10 flat head screws (with anti-rotation protection), nuts and spring washer
- Round conductor: with KS connector, e.g. Part No. 301 000 / 301 019 or with clamping frame, e.g. Part No. 390 150

1x 4 terminals

Part No.	472 309
Material	StSt
Cross-section	105 mm ²
Connection holes	11 x 11 mm
Dimensions (l x w x d)	232 x 30 x 3.5 mm
Fixing	[2x] 12 x 15 mm
Standard	EN 62561-1
PU	1 pc(s)



1x 6 terminals

Part No.	472 319
Material	StSt
Cross-section	105 mm ²
Connection holes	11 x 11 mm
Dimensions (l x w x d)	292 x 30 x 3.5 mm
Fixing	[2x] 12 x 15 mm
Standard	EN 62561-1
PU	1 pc(s)



1x 8 terminals



Part No.	472 329
Material	StSt
Cross-section	105 mm ²
Connection holes	11 x 11 mm
Dimensions (l x w x d)	352 x 30 x 3.5 mm
Fixing	[2x] 12 x 15 mm
Standard	EN 62561-1
PU	1 pc(s)

1x 10 terminals



Part No.	472 339
Material	StSt
Cross-section	105 mm ²
Connection holes	11 x 11 mm
Dimensions (l x w x d)	412 x 30 x 3.5 mm
Fixing	[2x] 12 x 15 mm
Standard	EN 62561-1
PU	1 pc(s)

1x 12 terminals



Part No.	472 349
Material	StSt
Cross-section	105 mm ²
Connection holes	11 x 11 mm
Dimensions (l x w x d)	472 x 30 x 3.5 mm
Fixing	[2x] 12 x 15 mm
Standard	EN 62561-1
PU	1 pc(s)

Special designs are available on request.

Two-Row Earthing Busbars

Earthing busbars for screwing on steel constructions, hole spacing 50 mm.

Connection possibilities:

- Flat strip with hole: with hexagon screws M10, nuts and spring washer
- Flat strip (-40 mm) without hole: with clamping plate of disconnecting clamps, e.g. Part No. 454 100
- Round conductor: with KS connector, e.g. Part No. 301 000 / 301 019 or with clamping piece, e.g. Part No. 390 150

2x 2 terminals



Part No.	472 023	472 109
Material	St/tZn	StSt
Cross-section	240 mm ²	300 mm ²
Connection holes Ø	11 mm	11 mm
Dimension s (l x w x d)	196 x 60 x 4 mm	196 x 60 x 5 mm
Fixing	[2x] 12 x 15 mm	[2x] 12 x 15 mm
Standard	EN 62561-1	EN 62561-1
PU	1 pc(s)	1 pc(s)

2x 3 terminals



Part No.	472 022	472 119
Material	St/tZn	StSt
Cross-section	240 mm ²	300 mm ²
Connection holes Ø	11 mm	11 mm
Dimension s (l x w x d)	242 x 60 x 4 mm	242 x 60 x 5 mm
Fixing	[2x] 12 x 15 mm	[2x] 12 x 15 mm
Standard	EN 62561-1	EN 62561-1
PU	1 pc(s)	1 pc(s)

2x 4 terminals

Part No.	472 024	472 129
Material	St/tZn	StSt
Cross-section	240 mm ²	300 mm ²
Connection holes Ø	11 mm	11 mm
Dimension s (l x w x d)	293 x 60 x 4 mm	293 x 60 x 5 mm
Fixing	[2x] 12 x 15 mm	[2x] 12 x 15 mm
Standard	EN 62561-1	EN 62561-1
PU	1 pc(s)	1 pc(s)



2x 6 terminals

Part No.	472 021	472 139
Material	St/tZn	StSt
Cross-section	240 mm ²	300 mm ²
Connection holes Ø	11 mm	11 mm
Dimension s (l x w x d)	393 x 60 x 4 mm	393 x 60 x 5 mm
Fixing	[2x] 12 x 15 mm	[2x] 12 x 15 mm
Standard	EN 62561-1	EN 62561-1
PU	1 pc(s)	1 pc(s)



Special designs are available on request.

Earthing Pipe Clamps

Earthing pipe clamps for integrating pipes into the protective and functional equipotential bonding according to IEC 60364-4-41/5-54, with continuously adjustable tensioning strap.

Type BRS17

For connecting 1 or 2 conductors or through-wiring, connection cross-section 2.5-10 mm² (solid).

Part No.	540 920
Material	StSt
Clamping range pipe Ø	10-27 mm (1/8-3/4")
Dimensions of strap (l x w x d)	135 x 14 x 0.3 mm
Connection (solid)	2.5-10 mm ²
PU	10 pc(s)



Type standard

For connecting 1 or 2 conductors or through-wiring, connection cross-section 4-25 mm² (solid / stranded).

Part No.	540 910	540 911	540 912
Material	StSt	StSt	StSt
Clamping range pipe Ø	27-60 mm (3/4-2")	27-114 mm (3/4-4")	27-168 mm (3/4-6")
Dimensions of strap (l x w x d)	240 x 25 x 0.3 mm	410 x 25 x 0.3 mm	570 x 25 x 0.3 mm
Connection (solid / stranded)	4-25 mm ²	4-25 mm ²	4-25 mm ²
Standard	EN 62561-1	EN 62561-1	EN 62561-1
PU	10 pc(s)	10 pc(s)	10 pc(s)



Separate grip head

For combination with endless tensioning strap (Part No. 540 901), connection cross-section 4-25 mm² (solid / stranded).

Part No.	540 900
Material	StSt
Connection	4-25 mm ²
Standard	EN 62561-1
PU	50 pc(s)



Endless tensioning strap

For cutting to length, e.g with snips.

Part No.	540 901
Material	StSt
Dimensions of strap (w x d)	25 x 0.3 mm
Length	100 m
Military Name	VG 96953 T05 BB001
PU	1 pc(s)



Antenna Earthing

Pipe clamp for lightning equipotential bonding of pipes (e.g. antenna poles) according to IEC/EN 62305-3. With gradually adjustable tensioning strap, for connecting one or two conductors and suitable for through-wiring.

Pipe clamps for antennas – complete

Connection for: 1 conductor Rd Ø10 mm or 1-2 conductors Rd Ø6-8 mm or 4-50 mm² (solid / stranded).



Part No.	540 103	540 100
Material	StSt	StSt
Clamping range pipe Ø	16-89 mm (3/8-3")	16-168 mm (3/8-6")
Dimensions of strap (l x w x d)	330 x 25 x 0.3 mm	570 x 25 x 0.3 mm
Connection (solid / stranded)	4-50 mm ²	4-50 mm ²
Screw	☒ M8 x 20 mm	☒ M8 x 20 mm
Material of screw	StSt	StSt
Standard	EN 62561-1	EN 62561-1
Military Name	VG 96953 T05 B0001	VG 96953 T05 B0002
Stock No.	—	5975-12-120-7744
PU	10 pc(s)	10 pc(s)



Separate grip head

For combination with endless tensioning strap (Part No. 540 901).

Connection for: 1 conductor Rd Ø10 mm or 1-2 conductors Rd Ø6-8 mm or 4-50 mm² (solid / stranded).

Part No.	540 110
Material	StSt
Connection (solid / stranded)	4-50 mm ²
Screw	☒ M8 x 20 mm
Material of screw	StSt
Standard	EN 62561-1
Military Name	VG 96953 T05 BA001
PU	50 pc(s)

Endless tensioning strap

For cutting to length, e.g. with snips.



Part No.	540 901
Material	StSt
Dimensions of strap (w x d)	25 x 0.3 mm
Length	100 m
Military Name	VG 96953 T05 BB001
PU	1 pc(s)

Connecting clamp for earth rods

Connection clamp for lightning equipotential bonding connection of pipes (e.g. antenna pole) to the earth rod via a solid /stranded conductor.



Part No.	540 121
Material	StSt (V4A)
Material No.	1.4571 / 1.4404 / 1.4401
ASTM / AISI:	316Ti / 316L / 316
For earth rods Ø	20-25 mm
Clamping range Rd	8-10 mm
Connection (solid / stranded)	4-50 mm ²
Screw	☒ M8 x 20 / 25 mm
Standard	EN 62561-1
PU	25 pc(s)

UNI KS connector

Universal clamping screw connector for lightning current carrying connection of round conductors and also of solid / stranded conductors, e.g. to flat profiles, downpipe clamps as well as equipotential bonding bars.

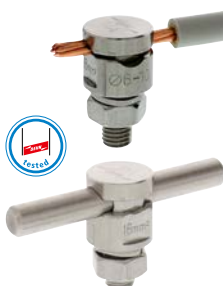

Part No.	540 122
Material	StSt (V4A)
Material No.	1.4571 / 1.4404 / 1.4401
ASTM / AISI:	316Ti / 316L / 316
Clamping range Rd	6-10 mm
Connection (solid / stranded)	16-50 mm ²
Screw	M10 mm
Standard	EN 62561-1
PU	25 pc(s)

Gutter clamp

Gutter clamp for lightning current carrying connection of the antenna earthing (e.g. 16 mm²) at the intersection with the gutter.

Part No.	540 120
Material	StSt
Clamping range bead	16-22 mm
Clamping range Rd	8-10 mm
Connection (solid / stranded)	4-50 mm ²
Screw	M8 x 20 / 25 mm
Material of screw	StSt
Standard	EN 62561-1
PU	25 pc(s)



Lightning Protection Pipe Clamp with Tines

Pipe clamp for the integration of pipes with surface protection into the lightning equipotential bonding according to IEC/EN 62305-3.

For use on surfaces (e.g. varnished or powder-coated) with a coating thickness up to 0.2 mm.

The special tines penetrate the surface protection and provide the necessary contact so that it is not necessary to remove the surface protection.

Lightning protection pipe clamp with tines, complete

Connection for: 1 conductor Rd Ø10 mm or 1-2 conductors Rd Ø6-8 mm or 4-50 mm² (solid / stranded).

Part No.	540 200
Material	StSt
Clamping range pipe Ø	27-168 mm (3/4-6")
Dimensions of strap (l x w x d)	570 x 25 x 0.3 mm
Standard	EN 62561-1
PU	10 pc(s)



Grip head, separate

For combination with endless tensioning strap (Part No. 540 901).

Connection for: 1 conductor Rd Ø10 mm or 1-2 conductors Rd Ø6-8 mm or 4-50 mm² (solid / stranded).

Part No.	540 210
Material	StSt
Standard	EN 62561-1
PU	50 pc(s)



Lightning Protection Earthing Pipe Clamps

Earthing pipe clamps for integrating pipes into the protective and functional equipotential bonding according to IEC 60364-4-41/60364-5-54 and lightning equipotential bonding according to IEC/EN 62305-3.

The clamping range (specified in mm) refers to the outer diameter according to DIN EN ISO 228-1 of the pipes.

With M10 screws

Connection for Rd 4-10 mm or conductor cross-section max. 70 mm².

General technical data:			
Material	MCl / St/tZn		
Standard	EN 62561-1		
Part No.	407 012	407 034	407 100
Clamping range pipe Ø	21 mm	27 mm	34 mm
Dimensions (l x r)	80 x 11 mm	83 x 14 mm	85 x 17.5 mm
PU	10 pc(s)	10 pc(s)	10 pc(s)
Part No.	407 114	407 112	407 200
Clamping range pipe Ø	42 mm	48 mm	60 mm
Dimensions (l x r)	100 x 24.5 mm	95 x 22 mm	113 x 30.5 mm
PU	10 pc(s)	10 pc(s)	1 pc(s)



Type St/tZn with M8 screws

St/tZn, material thickness 3 mm.

Connection for FI with M10 screws and nuts, for Rd 7-10 mm, e.g. KS connector (Part No. 301 000) or clamping piece (Part No. 390 150).

General technical data:

Material	St/tZn
Standard	EN 62561-1

Part No.	410 038	410 012	410 034	410 100
Clamping range pipe Ø	17 mm	21 mm	27 mm	34 mm
Dimensions (l x r)	110 x 8.5 mm	115 x 10.5 mm	115 x 13.5 mm	124 x 17 mm
PU	25 pc(s)	25 pc(s)	25 pc(s)	25 pc(s)

Part No.	410 114	410 112	410 134
Clamping range pipe Ø	42 mm	48 mm	55 mm
Dimensions (l x r)	132.5 x 21 mm	140.5 x 24 mm	145 x 27.5 mm
PU	25 pc(s)	25 pc(s)	1 pc(s)

Part No.	410 200	410 212	410 300
Clamping range pipe Ø	60 mm	76 mm	89 mm
Dimensions (l x r)	151 x 30 mm	169 x 38 mm	182.5 x 44.5 mm
PU	25 pc(s)	1 pc(s)	1 pc(s)

**Type StSt with M8 screws**

StSt, material thickness 2.5 mm.

Connection for FI with M10 screws and nuts, for Rd 7-10 mm, e.g. KS connector (Part No. 301 000) or clamping piece (Part No. 390 150).

General technical data:

Material	StSt
Standard	EN 62561-1

Part No.	410 309	410 319	410 329	410 339
Clamping range pipe Ø	17 mm	21 mm	27 mm	34 mm
Dimensions (l x r)	110.5 x 8.5 mm	114.5 x 10.5 mm	115.5 x 13.5 mm	124 x 17 mm
PU	1 pc(s)	25 pc(s)	25 pc(s)	25 pc(s)

Part No.	410 349	410 359	410 369
Clamping range pipe Ø	42 mm	48 mm	55 mm
Dimensions (l x r)	132.5 x 21 mm	140.5 x 24 mm	145 x 27.5 mm
PU	1 pc(s)	1 pc(s)	25 pc(s)

Part No.	410 379	410 389	410 399
Clamping range pipe Ø	60 mm	76 mm	89 mm
Dimensions (l x r)	151 x 30 mm	169 x 38 mm	182.5 x 44.5 mm
PU	1 pc(s)	1 pc(s)	1 pc(s)

**UNI Saddle Clamp**

For integrating mounting systems, e.g. of PV installations, in the functional equipotential bonding / functional earthing (black conductor possible) and lightning equipotential bonding.

The StSt contact plate (intermediate element) allows different conductor materials (Cu, Al, St/tZn and StSt) to be connected to the normal mounting systems, e.g. to aluminium, without the risk of contact corrosion.

With M8 screw and self-locking nut

Part No.	365 250
Clamping range of saddle	0.7-8 mm
Material of clamping bracket	Al
Clamping range Rd	8-10 mm
Connection (solid / stranded)	4-50 mm ²
Material of double clamp	StSt
Standard	EN 62561-1
PU	50 pc(s)



UNI Earthing Clamps

For integrating the mounting systems, e.g. of PV installations in the functional equipotential bonding / functional earthing (black conductor possible) and lightning equipotential bonding.

The StSt contact plate (intermediate element) allows different conductor materials (Cu, Al, St/tZn and StSt) to be connected to the usual mounting systems, e.g. to aluminium, without the risk of contact corrosion.

With M8 hammer-head bolt and self-locking nut

Part No.	540 250
Material of clamp	StSt
Clamping range Rd	8-10 mm
Connection (solid / stranded)	4-50 mm ²
Screw	hammer-head bolt M8 x 30 mm
Material of screw / nut	StSt
Standard	EN 62561-1
PU	50 pc(s)



With M10 hammer-head bolt and self-locking nut

Part No.	540 260
Material of clamp	StSt
Clamping range Rd	8-10 mm
Connection (solid / stranded)	4-50 mm ²
Screw	hammer-head bolt M10 x 30 mm
Material of screw / nut	StSt
Standard	EN 62561-1
PU	50 pc(s)



Contact plate and double clamp (separate) with square hole for M8 screw

Part No.	540 251
Material of clamp	StSt
Clamping range Rd	8-10 mm
Connection (solid / stranded)	4-50 mm ²
Standard	EN 62561-1
PU	10 pc(s)



Contact plate and double clamp (separate) with square hole for M10 screw

Part No.	540 261
Material of clamp	StSt
Clamping range Rd	8-10 mm
Connection (solid / stranded)	4-50 mm ²
Standard	EN 62561-1
PU	10 pc(s)



Protective Spark Gap

Protective spark gap in closed design with plastic sheath for indirect connection of an overhead line roof pole to the external lightning protection system.

DSFS

Plastic-insulated protective spark gap for indirect connection of an overhead line roof pole to the external lightning protection system.

Type	DSFS
Part No.	920 000
100% lightning impulse sparkover voltage (1.2/50 μs) (U _{rimp})	~ 25 kV
Nominal discharge current (8/20 μs) (I _n)	25 kA
Power frequency sparkover voltage (50 Hz) (U _{aw})	~ 10 kV
PU	1 pc(s)



Pipe Clamps for Service Entry Masts

For connecting spark gaps with service entry masts



Part No.	410 212	410 300
Clamping range Ø pipe	76 mm (2 1/2")	89 mm (3")
Material	St/tZn	St/tZn
Hole Ø	11 mm	11 mm
Standard	EN 62561-1	EN 62561-1
PU	1 pc(s)	1 pc(s)

Conductor Holders for Service Entry Masts

For fixing round conductors to service entry masts, insulated with clamp bush.



Part No.	425 076	425 089
Clamping range Ø pipe	76 mm	89 mm
Material	St/tZn	St/tZn
Conductor support Rd	8-10 mm	8-10 mm
Conductor routing	fixed	fixed
PU	50 pc(s)	1 pc(s)

Isolating Spark Gaps

For lightning equipotential bonding according to IEC/EN 62305 as well as for use in IT installations according to IEC 60364-5-54.



TFS / KFSU

Isolating spark gaps with plastic sheath and two stainless steel connections (Rd 10 mm).



Type	TFS	KFSU
Part No.	923 023	923 021
Isolating spark gap according to EN 62561-3 / IEC 62561-3	yes	yes
Lightning impulse current (10/350 µs) (I _{imp})	100 kA	—
Class (lightning current carrying capability)	H	—
Rated impulse sparkover voltage (U _{r,imp})	≤ 4 kV	≤ 4 kV
Degree of protection protection	IP 65	IP 65
PU	1 pc(s)	1 pc(s)

Downpipe Clamps

Pipe clamps for connecting down pipes to the lightning equipotential bonding according to IEC/EN 62305-3.

Connection possibilities for Rd, e.g. with KS connector (Part No. 301 000) or with clamping piece (Part No. 390 150) (depending on material).



For fixed pipe diameters

Part No.	420 100	420 120	420 107	420 127
Material	St/tZn	St/tZn	Cu	Cu
Clamping range pipe Ø	100 mm	120 mm	100 mm	120 mm
Hole Ø	11 mm	11 mm	11 mm	11 mm
Standard	EN 62561-1	EN 62561-1	EN 62561-1	EN 62561-1
PU	50 pc(s)	1 pc(s)	1 pc(s)	1 pc(s)

Equipotential Bonding

Bimetallic type

For connecting St conductors with Cu downpipes, with St/tZn clamping piece and intermediate plate (Cupal).

Part No.	420 207
Material	Cu / St/tZn
Clamping range pipe Ø	100 mm
Clamping range Rd	6-10 mm
Standard	EN 62561-1
PU	1 pc(s)



Type RV, adjustable

With additional anti-rotation protection of the fixing screw and markings, predetermined bending points as well as pre-punched cutting aids.

General technical data:	
Hole Ø	10.5 mm
Standard	EN 62561-1

Part No.	423 010	423 011	423 017	423 019
Material	St/tZn	Al	Cu	StSt
Clamping range pipe Ø	60-100 mm	60-100 mm	60-100 mm	60-100 mm
Length	337 mm	337 mm	337 mm	337 mm
PU	50 pc(s)	50 pc(s)	1 pc(s)	50 pc(s)



Part No.	423 020	423 021	423 027	423 029
Material	St/tZn	Al	Cu	StSt
Clamping range pipe Ø	60-150 mm	60-150 mm	60-150 mm	60-150 mm
Length	494 mm	494 mm	494 mm	494 mm
PU	50 pc(s)	50 pc(s)	50 pc(s)	50 pc(s)

Earthing Tong

- For connection to tank vehicles, aircraft, etc.
- For discharging static charge
- For use in hazardous areas



Small design

Brass jaw with steel tips (Material No. 1.4104) and copper contact clip.

Connection: Flat head screw with slot or with enclosed crimped cable lug 25 mm² – M6 (Cu/gal Sn).

Part No. 546 002 may also be combined with earthing conductor. See Safety Equipment catalogue Part No. 758 216.

Part No.	546 025	546 002
Material of tongs	St/gal Zn	StSt
Clamping range Rd / Fl	up to Ø16 / up to 13 mm	up to Ø16 / up to 13 mm
Length	140 mm	140 mm
Connection screw	M6 x 12 mm	M6 x 16 mm
PU	1 pc(s)	1 pc(s)



Large design

Brass jaw without steel tips and copper contact clip.

Connection: Threaded bolt with nut.

Part No.	546 000	546 001
Material of tongs	St/gal Zn	StSt
Clamping range Rd / Fl	up to Ø55 / up to 45 mm	up to Ø55 / up to 45 mm
Length	205 mm	205 mm
Connection nut	M10	M10
PU	1 pc(s)	1 pc(s)



Flat Strip / Round Conductor Holders with Thrust Piece

For wall mounting.
Thrust piece with M8 screw for installing flat strips up to 11 mm and round conductors 6-10 mm.

Distance from wall 11 mm



Part No.	277 230	277 237	277 239
Material of conductor holder	St/tZn	Cu	StSt
Fixing	Ø13 and 7 x 20 mm	Ø13 and 7 x 20 mm	Ø13 and 7 x 20 mm
Slot width	12 mm	12 mm	12 mm
Material of screw	StSt	StSt	StSt
Standard	EN 62561-4	EN 62561-4	EN 62561-4
PU	25 pc(s)	25 pc(s)	25 pc(s)

Distance from wall 15 mm



Part No.	277 240
Material of conductor holder	St/tZn
Fixing	7 x 15 mm
Slot width	12 mm
Material of screw	StSt
Standard	EN 62561-4
PU	25 pc(s)

Conductor Holder

Conductor holder for installing round and flat conductors for equipotential bonding, e.g. in transformer stations, processor rooms.
Insulated conductor holder.



Part No.	277 130
Conductor support Rd / Fl	6-13 / 30 x 4 mm
Fixing	Ø10 and 6 x 19 mm
Material	plastic
Colour	grey ●
PU	50 pc(s)

Connection Clamp

For universal connection to the ring equipotential bonding for St/tZn, copper or stainless steel (StSt).



Part No.	563 169
Conductor support Rd / Fl	Ø8-10 / 30 x 3 up to 11 mm
Material	StSt
Material of cage clamp	St/tZn
Connection cross section	2.5-95 mm ²
Short-circuit current (50 Hz) (1 s; ≤ 300 °C)	5.5 kA
PU	50 pc(s)

Equipotential Bonding on Cable Tray Systems for Ex zone 2/22 can be found on page 284

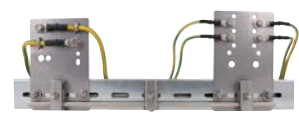

Pipe Clamps for Ex Zones 1/21, 2/22



Pipe clamp for electrically contacting pipes in Ex zones 1 and 2 (gases, vapours, mists) as well as Ex zones 21 and 22 (dusts). Non-sparking lightning equipotential bonding according to IEC/EN 62305-3.

- For use in Ex zones 1 and 2 (gases, vapours, mists) as well as Ex zones 21 and 22 (dusts)
- Tested according to explosion group IIB
- Time-saving installation – no need to deactivate systems/areas for welding or drilling works

Type EX BRS 27 Clamping range of Ø6-27 mm (3/4")

Part No.	540 821
Lightning impulse current (10/350 µs) Cu (I _{imp})	10 kA
Lightning impulse current (10/350 µs) Cu Ø12-27 mm (3/4") (I _{imp})	20 kA
Lightning impulse current (10/350 µs) Cu Ø27 mm (3/4") (I _{imp})	25 kA
Lightning impulse current (10/350 µs) St/tZn Ø17-27 mm (3/4") (I _{imp})	25 kA
Lightning impulse current (10/350 µs) StSt Ø6-12 mm (I _{imp})	10 kA
Lightning impulse current (10/350 µs) StSt Ø12-27 mm (3/4") (I _{imp})	12 kA
Lightning impulse current (10/350 µs) StSt Ø27 mm (3/4") (I _{imp})	25 kA
Connection	M8
Clamping range pipe Ø	6-27 mm (3/4")
Material of clamping body	polyamide
Material of grip head / tensioning strap	StSt
Material of contact piece	brass/gal Sn
Standard	based on EN 62561-1
PU	1 pc(s)



Type EX BRS 90 / 300 / 500

Type EX BRS 90 (Part No. 540 801) clamping range Ø27 (3/4") to 89 mm (3").

Type EX BRS 300 (Part No. 540 803) clamping range Ø89 (3") to 300 mm.

Type EX BRS 500 (Part No. 540 805) clamping range Ø300 to 500 mm.

Part No.	540 801	540 803	540 805
Lightning impulse current (10/350 µs) Cu (I _{imp})	50 kA	50 kA	—
Lightning impulse current (10/350 µs) St/tZn (I _{imp})	50 kA	50 kA	—
Lightning impulse current (10/350 µs) St/bare (I _{imp})	—	—	50 kA
Lightning impulse current (10/350 µs) StSt (I _{imp})	25 kA	50 kA	50 kA
Connection	M10	M10	M10
Clamping range pipe Ø	27-89 mm (3/4"-3")	89 (3")-300 mm	300-500 mm
Material of clamping body	polyamide	polyamide	polyamide
Material of grip head / tensioning strap	StSt	StSt	StSt
Material of contact piece	Cu/gal Sn	Cu/gal Sn	Cu/gal Sn
Standard	EN 62561-1	EN 62561-1	EN 62561-1
PU	1 pc(s)	1 pc(s)	1 pc(s)



Separate clamping body For use with endless tensioning strap (Part No. 540 901), clamping ranges Ø27 (3/4") to 500 mm.

Part No.	540 810
Lightning impulse current (10/350 µs) Cu (I _{imp})	50 kA
Lightning impulse current (10/350 µs) St/tZn (I _{imp})	50 kA
Lightning impulse current (10/350 µs) StSt (I _{imp})	25 kA
Connection	M10
Clamping range pipe Ø	27 (3/4")-500 mm
Material of clamping body	polyamide
Material of grip head / tensioning strap	StSt
Material of contact piece	Cu/gal Sn
Standard	EN 62561-1
PU	1 pc(s)



Environmental requirements related to the corrosion resistance of the materials used for the Ex pipe clamps Ex BRS ... (e.g. Cu/galSn, brass/galSn, StSt, polyamide) have to be taken into account.

Accessories for Pipe Clamps for Hazardous Areas Zone 1/21, 2/22

Tensioning strap

Part No.	540 901
Material	StSt
Strap dimensions (w x d)	25 x 0.3 mm
Length	100 m
Military Name	VG 96953 T05 BB001
PU	1 pc(s)



Parallel Connectors for Ex Zones 1/21, 2/22



Parallel connector with spring washer for connecting round conductors/cables in Ex zones 1/21, 2/22. The clamps are secured against self-loosening in accordance with DIN EN 62305-3 Supplement 2.

For equal and different cable diameters, small

Part No.	306 105
Material of clamp	Cu/gal Sn
Clamping range Rd / Rd	5-12.5 mm
Clamping range (stranded / cable)	16-95 mm ²
Lightning impulse current (10/350 μs) non-sparking	25 kA
Short-circuit current (50 Hz) (0.1 s) non-sparking	1.65 kA
Standard	based on EN 62561-1
PU	1 pc(s)



For equal and different cable diameters, large

Part No.	306 106
Material of clamp	Cu/gal Sn
Clamping range Rd / Rd	5-16 mm
Clamping range (stranded / cable)	16-150 mm ²
Lightning impulse current (10/350 μs) non-sparking	25 kA
Short-circuit current (50 Hz) (0.1 s) non-sparking	1.65 kA
Standard	based on EN 62561-1
PU	1 pc(s)



Pipe Clamp GSG for Ex Zone 2/22

Pipe clamp for electrically contacting pipes in Ex zone 2/22. The pipe clamp is secured against self-loosening according to DIN/EN 62305-3 Supplement 2.

Pipe clamps – Complete

Part No.	540 104
Material	StSt
Clamping range pipe Ø	27-89 mm (3/4-3")
Dimensions of strap (l x w x d)	330 x 25 x 0.3 mm
Connection (solid / stranded)	4-50 mm ²
Standard	EN 62561-1
Tightening torque	≥ 15 Nm
PU	10 pc(s)



Separate grip head

For combination with endless tensioning strap (Part No. 540 901), connection cross-section 4-50 mm² (solid / stranded).

Part No.	540 199
Material	StSt
Connection (solid / stranded)	4-50 mm ²
Standard	EN 62561-1
PU	25 pc(s)



Endless tensioning strap

For cutting to length, e.g. with snips.

Part No.	540 901
Material	StSt
Dimensions of strap (w x d)	25 x 0.3 mm
Military Name	VG 96953 T05 BB001
PU	1 pc(s)



Clamps for Ex Zone 2/22

Clamps with spring washer for connecting round / flat conductors in Ex zone 2/22. The clamps are secured against self-loosening according to DIN EN 62305-3 Supplement 2.



UNI disconnecting clamp 200 kA (10/350 µs) with spring washer for two round conductors

Part No.	459 200
Material	StSt
Clamping range Rd / Rd	10 / 10 mm
Clamping range Rd / Fl	10 / 30 mm
Lightning current carrying capability (10/350 µs)	200 kA
Standard	based on EN 62561-1
PU	1 pc(s)



UNI disconnecting clamp 200 kA (10/350 µs) with spring washer for earth entry rods

Part No.	459 219
Material	StSt
Clamping range Rd / Rd	8-10 / 16 mm
Lightning current carrying capability (10/350 µs)	200 kA
Standard	based on EN 62561-1
PU	1 pc(s)



Clamping piece 200 kA (10/350 µs) with spring washer

Part No.	380 209
Material	StSt
Clamping range Fl	30 x 4 mm
Lightning current carrying capability (10/350 µs)	200 kA
Standard	based on EN 62561-1
PU	1 pc(s)



KS connector 200 kA (10/350 µs) with spring washer

Part No.	301 209
Material	StSt
Clamping range Rd	10 mm
Lightning current carrying capability (10/350 µs)	200 kA
Standard	based on EN 62561-1
PU	1 pc(s)



MV clamp 200 kA (10/350 µs) with spring washer for round conductors

Part No.	390 209
Material	StSt
Clamping range Rd / Rd	8-10 mm
Lightning current carrying capability (10/350 µs)	200 kA
Standard	based on EN 62561-1
PU	1 pc(s)



MV clamp 200 kA (10/350 µs) with spring washer for air-termination rods

Part No.	392 209
Material	StSt
Clamping range Rd / Rd	8-10 / 16 mm
Lightning current carrying capability (10/350 µs)	200 kA
Standard	based on EN 62561-1
PU	1 pc(s)



Equipotential Bonding for Ex Areas

KS connector 100 kA (10/350 μs), one-piece, with spring washer

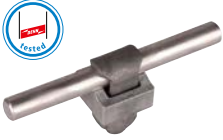

Part No.	301 010	301 017
Material of clamping screw	St/tZn	Cu
Material of clamp	ZDC	RCB
Clamping range Rd	7-10 mm	6-10 mm
Connection (solid / stranded)	—	25-70 mm ²
Type	+ spring washer	+ spring washer
Lightning current carrying capability (10/350 μs)	100 kA	100 kA
Standard	EN 62561-1	EN 62561-1
PU	100 pc(s)	1 pc(s)

KS connector 100 kA (10/350 μs), two-piece, with spring washer



Part No.	301 229
Material of clamping screw	StSt
Material of clamp	StSt
Clamping range Rd	6-10 mm
Type	+ spring washer
Lightning current carrying capability (10/350 μs)	100 kA
Standard	EN 62561-1
PU	1 pc(s)

Equipotential Bonding Busbars for Ex Zone 2/22

Equipotential bonding busbars for protective and functional equipotential bonding according to IEC 60364-4-41/60364-5-54 and lightning equipotential bonding according to IEC/EN 62305-3. Screws are secured against self-loosening according to DIN EN 62305-3 Supplement 2 by means of a spring washer.

6 terminals



Part No.	472 207	472 209
Material	Cu	StSt
Dimensions (l x w x d)	295 x 40 x 5 mm	295 x 40 x 6 mm
Cross section	200 mm ²	240 mm ²
Short-circuit current (50 Hz) (1 s; ≤ 300 °C)	39 kA	8.9 kA
Screw	⚙ M10 x 25 mm	⚙ M10 x 25 mm
Material of screw / nut	StSt	StSt
Design	with spring washer	with spring washer
Material of insulator	UP	UP
Standard	EN 62561-1	EN 62561-1
PU	1 pc(s)	1 pc(s)

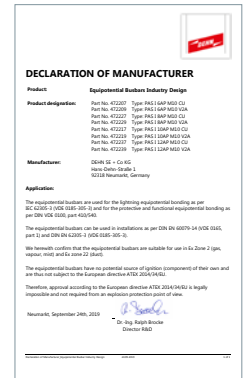

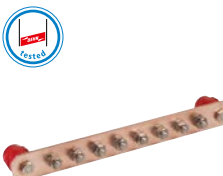

8 terminals



Part No.	472 227	472 229
Material	Cu	StSt
Dimensions (l x w x d)	365 x 40 x 5 mm	365 x 40 x 6 mm
Cross section	200 mm ²	240 mm ²
Short-circuit current (50 Hz) (1 s; ≤ 300 °C)	39 kA	8.9 kA
Screw	⚙ M10 x 25 mm	⚙ M10 x 25 mm
Material of screw / nut	StSt	StSt
Design	with spring washer	with spring washer
Material of insulator	UP	UP
Standard	EN 62561-1	EN 62561-1
PU	1 pc(s)	1 pc(s)



Equipotential Bonding for Ex Areas

10 terminals

Part No.	472 217	472 219
Material	Cu	StSt
Dimensions (l x w x d)	435 x 40 x 5 mm	435 x 40 x 6 mm
Cross section	200 mm ²	240 mm ²
Short-circuit current (50 Hz) (1 s; ≤ 300 °C)	39 kA	8.9 kA
Screw	 M10 x 25 mm	 M10 x 25 mm
Material of screw / nut	StSt	StSt
Design	with spring washer	with spring washer
Material of insulator	UP	UP
Standard	EN 62561-1	EN 62561-1
PU	1 pc(s)	1 pc(s)



12 terminals

Part No.	472 237	472 239
Material	Cu	StSt
Dimensions (l x w x d)	505 x 40 x 5 mm	505 x 40 x 6 mm
Cross section	200 mm ²	240 mm ²
Short-circuit current (50 Hz) (1 s; ≤ 300 °C)	39 kA	8.9 kA
Screw	 M10 x 25 mm	 M10 x 25 mm
Material of screw / nut	StSt	StSt
Design	with spring washer	with spring washer
Material of insulator	UP	UP
Standard	EN 62561-1	EN 62561-1
PU	1 pc(s)	1 pc(s)



Accessories for Equipotential Bonding Busbars for Ex Zone 2/22

Cover for EBB industry

Covers for EBB with insulators.

Part No.	472 279	472 269	472 289	472 299
Type of EBB	6 terminals	8 terminals	10 terminals	12 terminals
Dimensions (l x w x d)	301 x 60 x 0.8 mm	371 x 60 x 0.8 mm	441 x 60 x 0.8 mm	511 x 60 x 0.8 mm
Material	StSt	StSt	StSt	StSt
PU	1 pc(s)	1 pc(s)	1 pc(s)	1 pc(s)





Insulator for EBB industry

Part No.	472 210
Material	UP (thermoset)
Connection thread	M10 (length 12 mm)
Colour	red ●
Dimensions (d x h)	32 x 40 mm
PU	1 pc(s)



Fixing kit for EBB industry

For mounting the insulators, e.g. on walls.

Part No.	472 201	472 202
Material of screw	St/tZn	StSt
Screw	45 mm  M10 x 20 mm	45 mm  M10 x 20 mm
Plastic dowel	Ø12 x 60 mm	Ø12 x 60 mm
Total length	80 mm	80 mm
PU	1 pc(s)	1 pc(s)





Equipotential Bonding on Cable Tray Systems for Ex Zone 2/22

The equipotential bonding system is mounted on cable tray systems. All conductive system parts and electrical equipment are integrated in the Ex equipotential bonding by means of equipotential bonding plates and clamps as well as a closed ring equipotential bonding conductor.

EB clamp for cable trays and EB plate

Equipotential bonding clamp for cable trays

- Connection only with ring equipotential bonding conductor (tinned copper cable)
- For mounting on the perforated cable tray or on the equipotential bonding plate (PAP 1 / PAP 2)
- EB clamp to be mounted approx. every 0.5 m

General technical data:

Material	StSt
Material No.	1.4301
ASTM / AISI:	AISI 304
Connection to	PAP 1 EX KB ER or PAP 2 EX KB ER or cable tray or wide span cable tray
Material of screw / nut	StSt
Material No.	1.4301
ASTM / AISI:	AISI 304
EX zone	2/22



Part No.	306 200	306 201	306 202
Clamping range EB ring conductor	35 mm ² , Cu/gal Sn	50 mm ² , Cu/gal Sn	70 mm ² , Cu/gal Sn
Screw	M8 x 40 mm	M8 x 40 mm	M8 x 40 mm
Short-circuit current AC (50 Hz / 5 s)	1.5 kA	—	1.5 kA
Short-circuit current DC (5 s)	250 A	—	250 A
PU	50 pc(s)	50 pc(s)	50 pc(s)

Part No.	306 204	306 205	306 206
Clamping range EB ring conductor	35 mm ² , Cu/gal Sn	50 mm ² , Cu/gal Sn	70 mm ² , Cu/gal Sn
Screw	M6 x 35 mm	M6 x 35 mm	M6 x 35 mm
Short-circuit current AC (50 Hz / 5 s)	—	—	—
Short-circuit current DC (5 s)	—	—	—
PU	50 pc(s)	50 pc(s)	50 pc(s)

EB clamp for wire cable trays

Equipotential bonding clamp PAK for wire cable trays

- Connection only with ring equipotential bonding conductor 35 mm², Part No. 832 838 (tinned copper cable)
- For mounting on the wire cable tray or on the EB plate (PAP 1 / PAP 2)
- EB clamp to be mounted approx. every 0.5 m

Part No.	306 203
Material	StSt
Material No.	1.4301
ASTM / AISI:	AISI 304
Connection to	PAP 1 EX GI ER / PAP 2 EX GI ER or wire cable tray
Clamping range EB ring conductor	35 mm ² , Cu/gal Sn
Screw	M8 x 40 mm
Material of screw / nut	StSt
Material No.	1.4301
ASTM / AISI:	AISI 304
EX zone	2/22
Short-circuit current AC (50 Hz / 5 s)	1.5 kA
Short-circuit current DC (5 s)	250 A
PU	50 pc(s)



EB plate for cable trays

Equipotential bonding plate for cable trays

- For attaching the equipotential bonding clamp for the ring equipotential bonding conductor (tinned copper cable)
- For mounting on the perforated cable tray

Part No.	306 210	306 211
Material	StSt	StSt
Material No.	1.4301	1.4301
ASTM / AISI:	AISI 304	AISI 304
Dimensions	120 x 180 mm	120 x 195 mm
Connection holes for EB conductor with cable lug	3x Ø11 mm, 3x Ø9 mm, strain relief 3x cable clamp M6	2x Ø11 mm, 12x Ø7 mm
Connection possibilities for EB clamps	PAK ... EX KB ER	PAK ... EX KB ER
Fixing holes for cable tray	[4x] 9 x 20 / [1x] 9 x 9 mm	[4x] 9 x 20 / [1x] 9 x 9 mm
EX zone	2/22	2/22
Short-circuit current AC (50 Hz / 5 s)	1.5 kA	1.5 kA
Short-circuit current DC (5 s)	250 A	250 A
PU	15 pc(s)	15 pc(s)



EB plate for wire cable trays

- For attaching the equipotential bonding clamp for the ring equipotential bonding conductor (tinned copper cable)
- For mounting on the wire cable tray

Part No.	306 212	306 213
Material	StSt	StSt
Material No.	1.4301	1.4301
ASTM / AISI:	AISI 304	AISI 304
Dimensions	120 x 180 mm	120 x 195 mm
Connection holes for EB conductor with cable lug	3x Ø11 mm, 3x Ø9 mm, strain relief 3x cable clamp M6	2x Ø11 mm, 12x Ø7 mm
Connection possibilities for EB clamps	PAK ... EX KB ER	PAK ... EX KB ER
Fixing holes for wire cable tray	wire cable tray [4x] 9 x 20 / [1x] 9 x 9 mm	[4x] 9 x 20 / [1x] 9 x 9 mm
EX zone	2/22	2/22
Short-circuit current AC (50 Hz / 5 s)	1.5 kA	1.5 kA
Short-circuit current DC (5 s)	250 A	250 A
PU	15 pc(s)	15 pc(s)



EB pipe clamps Equipotential bonding pipe clamp (SBD 60 PAK 35)

- Connection only with ring equipotential bonding conductor 35 mm², Part No. 832 838 (tinned copper cable)
- For mounting on round pipe DN50 (60 mm)
- EB clamp to be mounted approx. every 0.5 m

Part No.	306 220
Material	StSt
Material No.	1.4301
ASTM / AISI:	AISI 304
Dimensions	Ø60 mm
Clamping range EB ring conductor	35 mm ² , Cu/gal Sn
EX zone	2/22
PU	50 pc(s)



Cable clamp as strain relief for installing copper cables on the equipotential bonding plate PAP1 EX KB ER or PAP1 EX GI ER.

Part No.	306 230	306 231
Material	StSt	StSt
Material No.	1.4301	1.4301
ASTM / AISI:	AISI 304	AISI 304
Connection to	PAP1 EX KB ER or PAP1 EX GI ER	PAP1 EX KB ER or PAP1 EX GI ER
Clamping range copper cable	35 mm ²	50 or 70 mm ²
EX zone	2/22	2/22
PU	10 pc(s)	10 pc(s)



Locknut for cable clamps (MPE S 35 ER and MPE S 50/70 ER).

Part No.	306 240
Material	StSt
Material No.	1.4301
ASTM / AISI:	AISI 304
Type	M6
EX zone	2/22
PU	20 pc(s)



Hexagon nut for cable clamps (MPE S 35 ER and MPE S 50/70 ER).

Part No.	505 901
Material	StSt
Material No.	1.4301
ASTM / AISI:	AISI 304
Type	M6
PU	20 pc(s)



Spring washer for cable clamps (MPE S 35 ER and MPE S 50/70 ER).

Part No.	524 906
Material	StSt
Material No.	1.4310
ASTM / AISI:	AISI 301
Type	A6
PU	20 pc(s)



Accessories for Equipotential Bonding on Cable Tray Systems for Ex Zone 2/22

Tinned copper cable For use as a ring equipotential bonding conductor or equipotential bonding.

Part No.	832 838	832 839	832 292
Cross-section	35 mm ²	50 mm ²	70 mm ²
Cable structure qty x Ø wire	7 x 2.5 mm	19 x 1.8 mm	19 x 2.1 mm
Material	Cu/gal Sn	Cu/gal Sn	Cu/gal Sn
PU	100 m	100 m	100 m





EXFS L / EXFS KU

For bridging insulating flanges and insulating glands in cathodically protected pipe sections (e.g., pipelines or LPG plants) in hazardous areas in case of surges and lightning currents.

EXFS L

Ex isolating spark gap for aboveground installation.



Type	EXFS L100	EXFS L200	EXFS L300
Part No.	923 060	923 061	923 062
Isolating spark gap according to EN 62561-3 / IEC 62561-3	yes	yes	yes
Lightning impulse current (10/350 μs) (I _{imp})	50 kA	50 kA	50 kA
Class (lightning current carrying capability)	N	N	N
Rated impulse sparkover voltage (U _{r imp})	≤ 2.5 kV	≤ 2.5 kV	≤ 2.5 kV
Degree of protection	IP 54	IP 54	IP 54
ATEX approvals	DEKRA 11ATEX0146 X	DEKRA 11ATEX0146 X	DEKRA 11ATEX0146 X
Ex marking according to EN 60079-0 and EN 60079-15: gas	II 3 G Ex nC IIC T4 Gc	II 3 G Ex nC IIC T4 Gc	II 3 G Ex nC IIC T4 Gc
IECEx approvals	IECEx DEK 11.0063X	IECEx DEK 11.0063X	IECEx DEK 11.0063X
Ex marking according to EN 60079-0	Ex nC IIC T4 Gc	Ex nC IIC T4 Gc	Ex nC IIC T4 Gc
Cable length	100 mm	200 mm	300 mm
PU	1 pc(s)	1 pc(s)	1 pc(s)

EXFS KU

Ex isolating spark gap with connecting cables for aboveground and underground installation; with water-proof sheath; can be shortened for short cable lengths.



Type	EXFS KU
Part No.	923 019
Isolating spark gap according to EN 62561-3 / IEC 62561-3	yes
Lightning impulse current (10/350 μs) (I _{imp})	50 kA
Class (lightning current carrying capability)	N
Rated impulse sparkover voltage (U _{r imp})	≤ 2.5 kV
Degree of protection	IP 67
ATEX approvals	DEKRA 11ATEX0146 X
Ex marking according to EN 60079-0 and EN 60079-15: gas	II 3 G Ex nC IIC T4 Gc
IECEx approvals	IECEx DEK 11.0063X
Ex marking according to EN 60079-0	Ex nC IIC T4 Gc
Cable length	2x approx. 1500 mm
PU	1 pc(s)

EXFS 100 / EXFS 100 KU



For bridging insulating flanges and insulating glands in cathodically protected pipe sections (e.g. pipelines or LPG plants) in hazardous areas in case of surges and lightning currents.

- Class (lightning current carrying capability) H (100 kA)
- Particularly low sparkover voltage
- ATEX and IECEx approvals for zone 1 and zone 21

EXFS 100

Isolating spark gap for use in hazardous areas with plastic sheath and M10 threaded screws.



Type	EXFS 100
Part No.	923 100
Isolating spark gap according to EN 62561-3 / IEC 62561-3	yes
Lightning impulse current (10/350 μs) (I _{imp})	100 kA
Class (lightning current carrying capability)	H
Rated impulse sparkover voltage (U _{r imp})	≤ 1.25 kV
Degree of protection	IP 67
Approvals	UL
ATEX approvals	DEKRA 11ATEX0178 X
Ex marking according to EN 60079-0 and EN 60079-1: gas	II 2 G Ex db IIC T6 Gb
Ex marking according to EN 60079-0 and EN 60079-31: dust	II 2 D Ex tb IIIC T80 °C Db IP 66/67
IECEx approvals	IECEx KEM 09.0051X
Ex marking according to EN 60079-0 and EN 60079-1: gas	Ex db IIC T6 Gb
Ex marking according to EN 60079-0 and EN 60079-31: dust	Ex tb IIIC T80 °C Db IP 66/67
Inmetro approvals	TÜV 17.0698 X
Ex marking according to EN 60079-0 and EN 60079-1: gas	Ex db IIC T6 Gb
Ex marking according to EN 60079-0 and EN 60079-31: dust	Ex tb IIIC T80 °C Db IP 66/67
PU	1 pc(s)

EXFS 100 KU

Ex isolating spark gap with connecting cable for aboveground and underground installation; with water-proof sheath; can be shortened for short cable lengths.

Type	EXFS 100 KU
Part No.	923 101
Isolating spark gap according to EN 62561-3 / IEC 62561-3	yes
Lightning impulse current (10/350 µs) (I_{imp})	100 kA
Class (lightning current carrying capability)	H
Rated impulse sparkover voltage ($U_{r imp}$)	≤ 1.25 kV
Degree of protection	IP 67
Approvals	UL
ATEX approvals	DEKRA 11ATEX0178 X
Ex marking according to EN 60079-0 and EN 60079-1: gas	II 2 G Ex d IIC T6 Gb
Ex marking according to EN 60079-0 and EN 60079-31: dust	II 2 D Ex tb IIIC T80 °C Db IP 66/67
IECEx approvals	IECEx KEM 09.0051X
Ex marking according to EN 60079-0 and EN 60079-1: gas	Ex d IIC T6 Gb
Ex marking according to EN 60079-0 and EN 60079-31: dust	Ex tb IIIC T80°C Db IP 66/67
Inmetro approvals	TÜV 17.0698 X
Ex marking according to EN 60079-0 and EN 60079-1: gas	Ex db IIC T6 Gb
Ex marking according to EN 60079-0 and EN 60079-31: dust	Ex tb IIIC T80 °C Db IP 66/67
Cable length	2x approx. 2000 mm
PU	1 pc(s)



Accessories for EXFS 100 / EXFS 100 KU

Angled connection brackets – IF 1 –

Angled connection bracket for EXFS ...; diameter corresponds to the bolt diameter of the flange joint; material: St/tZn.

Type	AB EXFS IF1 W 11	AB EXFS IF1 W 14	AB EXFS IF1 W 18	AB EXFS IF1 W 22
Part No.	923 311	923 314	923 318	923 322
Borehole diameter d1	11 mm	14 mm	18 mm	22 mm
PU	1 pc(s)	1 pc(s)	1 pc(s)	1 pc(s)

Type	AB EXFS IF1 W 26	AB EXFS IF1 W 30	AB EXFS IF1 W 33
Part No.	923 326	923 330	923 333
Borehole diameter d1	26 mm	30 mm	33 mm
PU	1 pc(s)	1 pc(s)	1 pc(s)

Type	AB EXFS IF1 W 36	AB EXFS IF1 W 39	AB EXFS IF1 W 42
Part No.	923 336	923 339	923 342
Borehole diameter d1	36 mm	39 mm	42 mm
PU	1 pc(s)	1 pc(s)	1 pc(s)

Type	AB EXFS IF1 W 48	AB EXFS IF1 W 56	AB EXFS IF1 W 62
Part No.	923 348	923 356	923 362
Borehole diameter d1	48 mm	56 mm	62 mm
PU	1 pc(s)	1 pc(s)	1 pc(s)



Flat connection brackets – IF 3 –

Flat connection bracket for EXFS ...; diameter corresponds to the bolt diameter of the flange joint; material: St/tZn.

Type	AB EXFS IF3 G 11	AB EXFS IF3 G 14	AB EXFS IF3 G 18	AB EXFS IF3 G 22
Part No.	923 211	923 214	923 218	923 222
Borehole diameter d1	11 mm	14 mm	18 mm	22 mm
PU	1 pc(s)	1 pc(s)	1 pc(s)	1 pc(s)

Type	AB EXFS IF3 G 26	AB EXFS IF3 G 30	AB EXFS IF3 G 33
Part No.	923 226	923 230	923 233
Borehole diameter d1	26 mm	30 mm	33 mm
PU	1 pc(s)	1 pc(s)	1 pc(s)

Type	AB EXFS IF3 G 36	AB EXFS IF3 G 39	AB EXFS IF3 G 42
Part No.	923 236	923 239	923 242
Borehole diameter d1	36 mm	39 mm	42 mm
PU	1 pc(s)	1 pc(s)	1 pc(s)

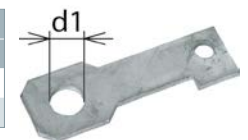

EXFS 100: Connecting cable, Cu, 25 mm²

Connecting cable for EXFS 100; two cable lugs (Ø10.5 mm) made of Cu/gal Sn, screw, nut and spring washer.

Type	AL EXFS L100 KS	AL EXFS L200 KS	AL EXFS L300 KS
Part No.	923 025	923 035	923 045
Cable length	100 mm	200 mm	300 mm
PU	1 pc(s)	1 pc(s)	1 pc(s)





DEHN protects.

Earth Resistance Meter MI 3123



For all kinds of earth resistance measurement, such as the 4-conductor method (Wenner method) for measuring the soil resistivity and resistance measurements in earth-termination systems.

Accessories:

- Power supply adapter + 6 batteries NiMH AA
- CD with instruction manual and handbook
- Calibration certificate for first calibration
- PC software Euro Link Pro PLUS according to ZVEH for Smartec incl. USB/RS232 cable
- Padded carrying bag and hand strap

The earthing test leads, test clamps and augers must be ordered separately.

Part No.	578 351
Display	digital LCD display
Resistance measuring range acc. to EN 61557	0.67 to 9 999 ohms
Measuring method	earth resistance, earth resistivity
Frequency of the test voltage	125 Hz
Measurement category	CAT IV
Dimensions (l x w x d)	135 x 230 x 75 mm
PU	1 pc(s)



Note: Accessories see pages 290 to 292!

Accessories for Earth Resistance Meter MI 3123

METREL A1018 clip-on current transducer (1000A / 1A current clamp with connection cable)

The Metrel A1018 clip-on current transducer with connection cable (length 1.5 m) and banana pins can be directly plugged into the earth resistance meter MI 3123. Connection points see METREL MI 3123 instruction manual.

Measuring methods on the down conductor:

- (Selective) earth resistance measurement with one current clamp
- Contactless earth resistance measurement (with both current clamps A1018 and A1019)

Part No.	578 352
Rated current	1000 A
Current measurement range	0.001 A - 1200 A
Overvoltage category	CAT III 600 V
Dimensions	220 x 120 x 48 mm
PU	1 pc(s)



METREL A1019 clip-on current transducer (1000A / 1A generator clamp with connection sockets)

The A1019 with banana sockets (Ø 4 mm) for connection via measuring cable to an MI3123 earth resistance meter. Connection points see METREL MI 3123 instructions for use.

Measuring methods on the down conductor:

- Contactless earth resistance measurement (with both current clamps A1018 and A1019)

Part No.	578 353
Rated current	1000 A
Current measurement range	0.2 A - 1200 A
Overvoltage category	CAT III 600 V
Dimensions	220 x 120 x 48 mm
PU	1 pc(s)



Earth Resistance Meter GEOHM C

For measuring the earth resistance and soil resistivity, with automatic selection of the measuring range and checking of sensor and auxiliary earth-electrode resistance.



Part No.	578 110
Display	digital LCD display
Resistance measuring range	0.01 to 20 000 Ω
Measuring frequency	45 to 200 Hz
Measuring method	3-/4-pole
Dimensions (l x w x d)	275 x 140 x 65 mm
PU	1 pc(s)



Earth Resistance Meter Metraclip Earth



For earth loop measurement.
Easy handling, high-resolution OLED display.
Automatic calibration, Bluetooth interface incl. software.



Part No.	578 386
Display	OLED display
Resistance measuring range	0.01 to 1 500 ohms
Current measuring range	0.2 mA to 40 A
Category of measurement	CAT IV 600 V
Clamp diameter inside	35 mm
PU	1 pc(s)

EP4 Continuity Tester



Continuity tester for measuring the resistance of e.g. air-termination and down conductors and subsequently installed reinforcing bars of buildings. The tester is suited for measuring the resistance of earth-termination systems according to DIN 18014 with a test current of 200 mA.



Part No.	578 370
Display	digital LCD display
Resistance measuring range	0.01 Ω to 2 000 k Ω
Measuring current	200 mA in the range up to 10 Ω acc. to EN 61557-4
Dimensions (l x w x d)	230 x 60 x 40 mm
PU	1 pc(s)

Case with Measuring Accessory for Continuity Tester

For storing the continuity tester and measuring accessories.

Equipment includes:

- 2 coilers with unwinding handle and 50 m measuring line, blue, with banana pin, Part No. 585 320
- 1 measuring line 0.75 mm², 3 m long, black, with banana pin on both sides, Part No. 545 020
- 1 test clamp, clamping range 2-21 mm, Part No. 588 000



Part No.	582 620
Material	artificial leather
Dimensions (l x w x h)	370 x 130 x 220 mm
PU	1 pc(s)

Earth Resistance Measuring Equipment in a Case

Case with shoulder strap for easy transport.

Equipment includes:

- 1 coiler with unwinding handle and 25 m red measuring line with banana pin, Part No. 585 310
- 1 coiler with unwinding handle and 50 m blue measuring line with banana pin, Part No. 585 320
- 2 auger drills, 350 mm long, Part No. 587 460
- 2 black measuring lines 0.75 mm², 3 m long, with banana pin on both sides, Part No. 545 010 (connection between earth-termination system and earth resistance meter)
- 1 red measuring line 0.75 mm², 0.5 m long, with banana pin on both sides, Part No. 545 010
- 1 blue measuring line 0.75 mm², 0.5 m long, with banana pin on both sides, Part No. 545 011 (connection between coiler and auger drill)
- 1 test clamp, clamping range 2-21 mm, Part No. 588 000



With storage compartment for Metrel MI 3123 or GEOHM C measuring device.

Part No.	582 600
Material	artificial leather
Dimensions (l x w x h)	400 x 200 x 240 mm
PU	1 pc(s)

Accessories for Earth Resistance Measuring Equipment in a Case

Auger

As an auxiliary earth electrode and probe for measuring the earth and soil resistance. With hole for banana pin of the measuring line.

Part No.	587 460
Connection	✻ M5
Material	MCl/gal Zn
Length	350 mm
PU	1 pc(s)



Test clamp up to 21 mm

For measuring earth electrodes.

Part No.	588 000
Connection	✻ M5
Material	MCl/tZn
Clamping range	2-21 mm
Clamping spindle	M8
PU	1 pc(s)



Test clamp up to 45 mm

For measuring earth electrodes.

Part No.	589 000
Connection	✻ M5
Material	MCl/tZn
Clamping range	4-45 mm
Clamping spindle	M10
PU	1 pc(s)



Coiler width 40 mm

With split plug, socket and handle.



Part No.	585 310	585 051	585 025	585 320
Length of measuring line	25 m	50 m	25 m	50 m
Colour of measuring line	red ●	red ●	blue ●	blue ●
Width	40 mm	40 mm	40 mm	40 mm
Material	plastic	plastic	plastic	plastic
PU	1 pc(s)	1 pc(s)	1 pc(s)	1 pc(s)

Coiler, width 80 mm

With split plug, socket and handle.



Part No.	585 211	585 210
Length of measuring line	100 m	100 m
Colour of measuring line	red ●	blue ●
Width	80 mm	80 mm
Material	plastic	plastic
PU	1 pc(s)	1 pc(s)

Coiler, empty

With socket and handle.



Part No.	585 010	585 200
Length of measuring line	0 m	0 m
Width	40 mm	80 mm
Material	plastic	plastic
Colour	grey ●	grey ●
PU	1 pc(s)	1 pc(s)

Measuring line

Part No.	545 000	545 001
Cross section	0.75 mm ²	0.75 mm ²
Material	Cu	Cu
Designation	H05V-K	H05V-K
Insulation	PVC	PVC
Colour	blue ●	red ●
PU	100 m	100 m

Lightning Strike Counter

Counter for digitally recording impulse currents.

The discharge current counter is preferably installed between the equipotential bonding bar and the earth-termination system.



Part No.	599 100
Operating current (8/20 μs) (I _{tc})	1 kA
Max. discharge current (10/350 μs) (I _{mcw})	100 kA
Clamping range Rd	8-10 mm
Clamping range Fl	max. 30 mm
Degree of protection	IP 65
PU	1 pc(s)

Wire Straighteners



For straightening round conductors of different materials (semi-rigid).

5 guide pulleys, with handles

Part No.	597 004
Material	St/gal Zn
Support Rd	7-10 mm
Material of guide pulleys	St/gal Zn
Dimensions	approx. 180 x 290 mm
PU	1 pc(s)



10 guide pulleys, with handles

Part No.	597 005
Material	St/gal Zn
Support Rd	7-10 mm
Material of guide pulleys	St/gal Zn
Dimensions	approx. 650 x 180 mm
PU	1 pc(s)



10 guide pulleys, with derrick

For stationary set-up.

Part No.	597 003
Material	St/tZn
Support Rd	7-10 mm
Material of guide pulleys	St/gal Zn
Dimensions	approx. 1350 x 580 mm
PU	1 pc(s)



10 guide pulleys, movable on rubber wheels

With wire unwinding device, for handling coils (St/tZn, Cu and Al) with an inner diameter of 450-800 mm and widths up to 150 mm.

Part No.	597 006
Material	St/tZn
Support Rd	7-10 mm
Material of guide pulleys	St/gal Zn
Dimensions	approx. 1650 x 1200 mm
PU	1 pc(s)



Straightening Tool



For bending and straightening conductors.

Straight design

Part No.	596 000
Material	St/burnished
For Rd / Fl	8-10 / -4 mm
Length	260 mm
PU	1 pc(s)



Cranked design

Wrench size 13 for screwing.

Part No.	595 000
Material	St/burnished
For Rd	8-10 mm
Length	260 mm
PU	1 pc(s)



Spider Wrench



Universal use installing lightning protection systems. With four wrench sizes.

Part No.	572 000
Material	St/gal Zn
Wrench size	10, 13, 17, 19 mm
PU	1 pc(s)

Anti-Corrosion Tape

For wrapping aboveground and underground connections in accordance with the requirements of DIN 12068. In reels, length 10 m, UV-stabilised.



Part No.	556 125	556 130
Material	petrolatum	petrolatum
Length	10 m	10 m
Width	50 mm	100 mm
PU	24 pc(s)	12 pc(s)

Heat-Shrinkable Sleeve

Heat-shrinkable sleeve for coating Rd and FI conductors, e.g. when leading terminal lugs out of the concrete or earth entries out of the ground. UV-stabilised, customised length.



Part No.	554 011
For Rd	16 mm
For FI	30 mm
Material	DERAY
Colour	black ●
PU	1 m

Part No. / GTIN* / PG / Weight / PU / SU / Page

Part No.	GTIN*	PG	Weight	PU	SU	Page
100 100	019119	01 01 01 01	1.64 kg	10	pc(s)	96
100 150	019140	01 01 01 01	2.44 kg	10	pc(s)	96
101 000	094505	01 01 01 01	212 g	20	pc(s)	95/111
101 001	105539	01 07 01 01	600 g	1	pc(s)	121
101 007	128705	01 01 01 01	700 g	20	pc(s)	95
101 009	128699	01 01 01 01	600 g	20	pc(s)	95/111
101 010	138698	01 01 01 01	208 g	10	pc(s)	112
101 110	138704	01 01 01 01	305 g	1	pc(s)	112
101 150	019515	01 02 01 01	2.42 kg	10	pc(s)	57/230
102 002	105126	01 01 01 01	17.02 kg	54	pc(s)	103
102 003	105133	01 01 01 01	8.52 kg	120	pc(s)	103
102 010	057814	01 01 01 01	17.62 kg	54	pc(s)	102/207
102 012	105089	01 01 01 01	17.60 kg	54	pc(s)	103/202
102 050	045996	01 01 01 01	217 g	1	pc(s)	103/207
102 060	094987	01 01 01 01	140 g	1	pc(s)	103/205
102 075	094215	01 01 01 01	8.46 kg	120	pc(s)	103/205
102 340	105119	01 01 01 01	17.82 kg	54	pc(s)	102/148
103 013	129818	01 01 01 02	228 kg	1	pc(s)	107
103 016	129825	01 01 01 02	230 kg	1	pc(s)	107
103 019	129832	01 01 01 02	310 kg	1	pc(s)	107
103 022	129849	01 01 01 02	452 kg	1	pc(s)	107
103 025	129856	01 01 01 02	550 kg	1	pc(s)	107
103 030	129917	01 01 01 02	2620 kg	1	pc(s)	108
103 031	129924	01 01 01 02	4900 kg	1	pc(s)	108
103 040	129894	01 01 01 02	22.90 kg	1	pc(s)	108
103 041	129900	01 01 01 02	38 kg	1	pc(s)	108
103 121	112711	01 01 01 02	33 kg	1	pc(s)	107
103 122	112728	01 01 01 02	33.20 kg	1	pc(s)	107
103 123	112735	01 01 01 02	37.60 kg	1	pc(s)	107
103 124	112742	01 01 01 02	37.60 kg	1	pc(s)	107
103 125	112759	01 01 01 02	42.20 kg	1	pc(s)	107
103 126	112841	01 01 01 02	42.40 kg	1	pc(s)	107
103 210	066311	01 01 01 01	480 g	10	pc(s)	95
103 211	078529	01 01 01 01	480 g	10	pc(s)	96
103 220	066328	01 01 01 01	760 g	10	pc(s)	95
103 221	078536	01 01 01 01	760 g	10	pc(s)	96
103 230	066335	01 01 01 01	1.02 kg	10	pc(s)	95
103 231	078543	01 01 01 01	1.02 kg	10	pc(s)	96
103 240	066342	01 01 01 01	1.30 kg	10	pc(s)	95
103 241	081857	01 01 01 01	1.30 kg	10	pc(s)	96
103 250	093485	01 01 01 01	1.52 kg	10	pc(s)	95
103 251	093515	01 01 01 01	1.52 kg	10	pc(s)	96
103 260	093492	01 01 01 01	1.85 kg	10	pc(s)	95
103 261	093522	01 01 01 01	1.73 kg	10	pc(s)	96
103 280	093508	01 01 01 01	2.40 kg	10	pc(s)	95
103 410	105775	01 01 01 01	360 g	10	pc(s)	96/111
103 417	128682	01 01 01 01	1.20 kg	10	pc(s)	96
103 419	128651	01 01 01 01	1.10 kg	10	pc(s)	96
103 420	105782	01 01 01 01	500 g	10	pc(s)	96
103 429	128668	01 01 01 01	1.60 kg	10	pc(s)	96
103 430	105799	01 01 01 01	570 g	10	pc(s)	96
103 439	128675	01 01 01 01	2.05 kg	10	pc(s)	96
103 440	105805	01 01 01 01	800 g	10	pc(s)	96
103 449	128798	01 01 01 01	2.57 kg	10	pc(s)	96
103 450	105812	01 01 01 01	900 g	10	pc(s)	96
103 460	105829	01 01 01 01	1.10 kg	10	pc(s)	96
103 480	105836	01 01 01 01	1.30 kg	10	pc(s)	96
104 150	028487	01 01 01 01	820 g	10	pc(s)	95
104 200	056343	01 01 01 01	1.08 kg	10	pc(s)	95

Part No.	GTIN*	PG	Weight	PU	SU	Page
104 250	056350	01 01 01 01	1.40 kg	10	pc(s)	95
104 300	056367	01 01 01 01	1.68 kg	10	pc(s)	95
104 600	076556	01 01 01 01	3.32 kg / pc(s)	1	pc(s)	96
104 903	030497	01 02 01 01	1.60 kg	10	pc(s)	57/230
104 905	030503	01 02 01 01	2.38 kg	10	pc(s)	57/230
104 906	082854	01 02 01 01	3.20 kg	10	pc(s)	57/230
105 071	101456	01 01 01 05	694 g	1	pc(s)	121/123
105 079	100183	01 01 01 05	96 g	1	pc(s)	121/124
105 140	112650	01 01 01 05	653 g	1	pc(s)	105/158
105 160	113022	01 01 01 05	506 g	1	pc(s)	106/158
105 161	118324	01 01 01 05	667 g	1	pc(s)	157
105 162	146433	01 01 01 05	600 g	1	pc(s)	106/158
105 163	248281	01 01 01 05	586 g	1	pc(s)	106
105 170	151192	01 01 01 01	4.17 kg	1	pc(s)	101
105 171	151215	01 01 01 01	5.60 kg	1	pc(s)	101
105 172	151239	01 01 01 01	7.20 kg	1	pc(s)	101
105 173	151253	01 01 01 01	8.60 kg	1	pc(s)	101
105 174	151277	01 01 01 01	10.14 kg	1	pc(s)	101
105 175	151208	01 01 01 01	4.40 kg	1	pc(s)	101
105 176	151222	01 01 01 01	6 kg	1	pc(s)	101
105 177	151246	01 01 01 01	7.45 kg	1	pc(s)	101
105 178	151260	01 01 01 01	9.00 kg	1	pc(s)	101
105 179	151284	01 01 01 01	10.40 kg	1	pc(s)	101
105 190	152045	01 01 01 01	9.20 kg	1	pc(s)	101
105 191	152052	01 01 01 01	12.60 kg	1	pc(s)	101
105 192	152069	01 01 01 01	16.20 kg	1	pc(s)	101
105 193	152076	01 01 01 01	19.40 kg	1	pc(s)	101
105 194	152083	01 01 01 01	22.40 kg	1	pc(s)	101
105 195	152090	01 01 01 01	10 kg	1	pc(s)	101
105 196	152106	01 01 01 01	14.30 kg	1	pc(s)	101
105 197	152113	01 01 01 01	16.80 kg	1	pc(s)	101
105 198	152120	01 01 01 01	20 kg	1	pc(s)	101
105 199	152137	01 01 01 01	23.60 kg	1	pc(s)	101
105 200	095908	01 01 01 01	9.60 kg	1	pc(s)	102/127
105 201	095915	01 01 01 01	17.23 kg	1	pc(s)	127/200
105 229	280625	01 07 01 01	89 g	10	pc(s)	145/204
105 240	135116	01 07 01 02	7.23 kg	1	pc(s)	161
105 241	361225	01 07 01 01	4.66 kg	1	pc(s)	104/161
105 245	135383	01 07 01 02	1.16 kg	1	pc(s)	161
105 246	135390	01 07 01 02	1.14 kg	1	pc(s)	161
105 272	255777	01 07 01 01	2.30 kg	1	pc(s)	157
105 273	255807	01 07 01 01	2.65 kg	1	pc(s)	157
105 274	255814	01 07 01 01	3.20 kg	1	pc(s)	157
105 280	255838	01 07 01 01	3.59 kg	1	pc(s)	157
105 281	260962	01 07 01 01	4 kg	1	pc(s)	160
105 288	256040	01 07 01 01	4.55 kg	1	pc(s)	159
105 290	126046	01 01 01 01	8.40 kg	1	pc(s)	102
105 291	126053	01 01 01 01	19 kg	1	pc(s)	102
105 300	098534	01 01 01 05	5.20 kg	1	pc(s)	124
105 301	098541	01 01 01 05	7.20 kg	1	pc(s)	124
105 302	100077	01 01 01 05	10.20 kg	1	pc(s)	124
105 306	106024	01 01 01 05	5.23 kg	1	pc(s)	124
105 314	157781	01 07 01 01	10 kg	1	pc(s)	175
105 315	157804	01 07 01 01	11 kg	1	pc(s)	175
105 316	157798	01 07 01 01	15.52 kg	1	pc(s)	175
105 317	157811	01 07 01 01	17 kg	1	pc(s)	175
105 320	152373	01 07 01 03	10.60 kg	1	pc(s)	198
105 321	152397	01 07 01 03	12.20 kg	1	pc(s)	198
105 322	152380	01 07 01 03	15.80 kg	1	pc(s)	198
105 323	152403	01 07 01 03	16.20 kg	1	pc(s)	198
105 325	157828	01 07 01 01	5.42 kg	1	pc(s)	175
105 326	157842	01 07 01 01	5.82 kg	1	pc(s)	176

Part No. / GTIN* / PG / Weight / PU / SU / Page

Part No.	GTIN*	PG	Weight	PU	SU	Page
105 327	157835	01 07 01 01	8.02 kg	1	pc(s)	175
105 328	157859	01 07 01 01	8.32 kg	1	pc(s)	176
105 330	152496	01 07 01 01	5.60 kg	1	pc(s)	175
105 331	152502	01 07 01 01	6 kg	1	pc(s)	175
105 332	152519	01 07 01 01	8.20 kg	1	pc(s)	175
105 333	152526	01 07 01 01	8.50 kg	1	pc(s)	175
105 336	157866	01 07 01 01	9.90 kg	1	pc(s)	175
105 337	157880	01 07 01 01	11.64 kg	1	pc(s)	176
105 338	157873	01 07 01 01	15.13 kg	1	pc(s)	175
105 339	157897	01 07 01 01	16.86 kg	1	pc(s)	176
105 340	098794	01 01 01 05	618 g	1	pc(s)	124/202
105 341	098800	01 01 01 05	607 g	1	pc(s)	124/203
105 342	111141	01 01 01 05	514 g	1	pc(s)	105/203
105 343	118515	01 01 01 05	3.60 kg	1	pc(s)	106/203
105 344	147300	01 01 01 05	1.52 kg	1	pc(s)	106/203
105 345	110489	01 01 01 05	3.60 kg	1	pc(s)	171/196
105 347	278554	01 01 01 05	2.42 kg	1	pc(s)	106/203
105 348	287013	01 01 01 05	540 g	1	pc(s)	105/203
105 349	288614	01 01 01 05	5.80 kg	1	pc(s)	106/203
105 351	238916	01 01 01 05	11.50 kg	1	pc(s)	177/199
105 354	098725	01 01 01 05	617 g	5	pc(s)	106/203
105 355	098732	01 01 01 05	690 g	1	pc(s)	126/203
105 356	098749	01 01 01 05	562 g	5	pc(s)	126/203
105 360	099777	01 01 01 05	358 g	1	pc(s)	125/202
105 361	102033	01 01 01 05	385 g	1	pc(s)	125/202
105 362	110496	01 01 01 05	467 g	1	pc(s)	126/202
105 363	106031	01 01 01 05	8.87 kg	1	pc(s)	181/204
105 364	106048	01 01 01 05	10.85 kg	1	pc(s)	181/204
105 365	106055	01 01 01 05	14.63 kg	1	pc(s)	181/204
105 376	115545	01 01 01 05	660 g	1	pc(s)	126/203
105 390	156944	01 07 01 01	6.30 kg	1	pc(s)	178/201
105 391	156951	01 07 01 01	22.90 kg	1	pc(s)	178/201
105 392	157903	01 07 01 03	10 kg	1	pc(s)	199
105 393	157927	01 07 01 03	12 kg	1	pc(s)	199
105 394	157910	01 07 01 03	15 kg	1	pc(s)	199
105 395	157934	01 07 01 03	17 kg	1	pc(s)	199
105 396	156487	01 07 01 01	1.80 kg	1	pc(s)	178/201
105 397	156494	01 07 01 01	2.50 kg	1	pc(s)	178/201
105 398	156500	01 07 01 01	3 kg	1	pc(s)	178/201
105 400	094383	01 01 01 01	13.40 kg	1	pc(s)	98
105 440	099692	01 01 01 05	7.64 kg	1	pc(s)	123
105 450	094413	01 01 01 01	13.80 kg	1	pc(s)	98
105 455	099715	01 01 01 05	11.45 kg	1	pc(s)	123
105 460	381513	01 07 01 02	529 g	1	pc(s)	148
105 461	381520	01 07 01 01	821 g	1	pc(s)	183
105 462	381537	01 07 01 03	830 g	1	pc(s)	206
105 467	381599	01 07 01 03	4.10 kg	1	pc(s)	206
105 468	381582	01 07 01 03	3.65 kg	1	pc(s)	206
105 469	381575	01 07 01 01	3.64 kg	1	pc(s)	183
105 470	100138	01 01 01 05	14.65 kg	1	pc(s)	123
105 490	156968	01 07 01 01	7.40 kg	1	pc(s)	178/201
105 491	156975	01 07 01 01	30 kg	1	pc(s)	178/201
105 496	156517	01 07 01 01	2.40 kg	1	pc(s)	178/201
105 497	156524	01 07 01 01	3.40 kg	1	pc(s)	178/201
105 498	156531	01 07 01 01	4 kg	1	pc(s)	178/201
105 500	094420	01 01 01 01	15 kg	1	pc(s)	98
105 513	270282	01 07 01 03	5 kg	1	pc(s)	199
105 515	271821	01 07 01 03	7.84 kg	1	pc(s)	199
105 525	241985	01 01 01 01	3.40 kg	1	pc(s)	97
105 530	242029	01 01 01 01	3.80 kg	1	pc(s)	97
105 535	242043	01 01 01 01	4.10 kg	1	pc(s)	97
105 543	271845	01 07 01 03	6.24 kg	1	pc(s)	199
105 545	271876	01 07 01 03	8.72 kg	1	pc(s)	199

Part No.	GTIN*	PG	Weight	PU	SU	Page
105 550	094437	01 01 01 01	15.20 kg	1	pc(s)	98
105 563	271937	01 07 01 03	5.54 kg	1	pc(s)	198
105 565	271944	01 07 01 03	7.92 kg	1	pc(s)	198
105 573	271975	01 07 01 03	6.40 kg	1	pc(s)	198
105 575	272026	01 07 01 03	8.74 kg	1	pc(s)	198
105 600	094444	01 01 01 01	29.40 kg	1	pc(s)	98
105 601	142336	01 01 01 01	6 kg	1	pc(s)	127/200
105 650	094451	01 01 01 01	30 kg	1	pc(s)	98
105 700	094468	01 01 01 01	31.20 kg	1	pc(s)	98
105 750	094475	01 01 01 01	31.40 kg	1	pc(s)	98
105 800	094338	01 01 01 01	32.60 kg	1	pc(s)	98
105 850	094482	01 01 01 01	32.80 kg	1	pc(s)	98
105 900	240766	01 01 01 01	33.29 kg	1	pc(s)	98
105 910	256941	01 01 01 01	53 kg	1	pc(s)	99
105 911	256958	01 01 01 01	54 kg	1	pc(s)	99
105 922	240520	01 01 01 01	97.31 kg	1	pc(s)	100
105 923	242081	01 01 01 01	98.31 kg	1	pc(s)	100
105 924	242104	01 01 01 01	103.31 kg	1	pc(s)	100
106 008	099241	01 01 01 01	352 g	1	pc(s)	112
106 090	100190	01 01 01 06	470 g	1	pc(s)	115
106 100	092907	01 01 01 06	545 g	1	pc(s)	115
106 105	100206	01 01 01 06	658 g	1	pc(s)	115
106 115	100213	01 01 01 06	488 g	1	pc(s)	115
106 120	092945	01 01 01 06	552 g	1	pc(s)	115
106 123	100220	01 01 01 06	686 g	1	pc(s)	115
106 125	099517	01 01 01 06	1.15 kg	10	pc(s)	116
106 126	093324	01 01 01 06	82 g	20	pc(s)	116
106 127	093317	01 01 01 06	228 g	20	pc(s)	117
106 128	123731	01 01 01 06	131 g	20	pc(s)	117
106 129	123748	01 01 01 06	135 g	20	pc(s)	117
106 150	092914	01 01 01 06	340 g	1	pc(s)	116
106 160	092938	01 01 01 06	286 g	1	pc(s)	116
106 165	100237	01 01 01 06	242 g	1	pc(s)	117
106 170	097285	01 01 01 06	310 g	1	pc(s)	117
106 175	100244	01 01 01 06	448 g	1	pc(s)	117
106 178	100251	01 01 01 06	260 g	1	pc(s)	117
106 180	097292	01 01 01 06	326 g	1	pc(s)	117
106 185	100268	01 01 01 06	465 g	1	pc(s)	117
106 207	127623	01 01 01 06	493 g	10	pc(s)	121
106 210	127630	01 01 01 06	625 g	10	pc(s)	121
106 217	128811	01 01 01 06	280 g	10	pc(s)	121
106 220	128828	01 01 01 06	410 g	10	pc(s)	121
106 225	100299	01 01 01 06	684 g	1	pc(s)	115
106 226	098930	01 01 01 06	722 g	1	pc(s)	115
106 228	100305	01 01 01 06	878 g	1	pc(s)	115
106 245	100336	01 01 01 06	561 g	1	pc(s)	116
106 246	098954	01 01 01 06	608 g	1	pc(s)	116
106 248	100343	01 01 01 06	762 g	1	pc(s)	116
106 301	096806	01 01 01 06	50 g	20	pc(s)	117
106 309	129276	01 01 01 06	100 g	20	pc(s)	117
106 310	096813	01 01 01 06	100 g	20	pc(s)	118
106 311	096820	01 01 01 06	150 g	20	pc(s)	118
106 312	098756	01 01 01 05	327 g	5	pc(s)	119/127
106 315	096943	01 01 01 06	98 g	20	pc(s)	118
106 316	096844	01 01 01 06	244 g	1	pc(s)	118
106 319	124820	01 01 01 06	271 g	1	pc(s)	120
106 320	149434	01 01 01 06	48 g	20	pc(s)	119
106 321	096851	01 01 01 06	121 g	10	pc(s)	119
106 322	097308	01 01 01 06	146 g	10	pc(s)	119
106 323	097315	01 01 01 06	110 g	10	pc(s)	119/210
106 324	099074	01 01 01 06	48 g	20	pc(s)	119/210
106 325	096929	01 01 01 06	222 g	10	pc(s)	120

Part No. / GTIN* / PG / Weight / PU / SU / Page

Part No.	GTIN*	PG	Weight	PU	SU	Page
106 326	096936	01 01 01 06	337 g	1	pc(s)	120
106 328	099098	01 01 01 05	547 g	1	pc(s)	127
106 331	100367	01 01 01 05	715 g	1	pc(s)	127
106 340	096868	01 01 01 06	104 g	20	pc(s)	120
106 341	096875	01 01 01 06	104 g	20	pc(s)	120
106 342	096882	01 01 01 06	104 g	20	pc(s)	120
106 352	096905	01 01 01 06	375 g	10	pc(s)	118/126
106 353	096912	01 01 01 06	466 g	1	pc(s)	118/126
106 812	104907	01 07 01 01	435 g	1	pc(s)	148
106 814	381483	01 07 01 03	673 g	1	pc(s)	206
106 815	381506	01 07 01 01	538 g	1	pc(s)	183
106 852	119307	01 07 01 02	229 g	1	pc(s)	148
108 009	133686	01 01 01 03	288 g	1	pc(s)	113
110 000	021440	01 01 01 03	20 g	50	pc(s)	113
110 017	021457	01 01 01 03	28 g	10	pc(s)	113
123 021	092822	01 01 01 03	2.20 kg	1	pc(s)	109
123 032	242067	01 01 01 03	17.70 kg	1	pc(s)	110
123 040	353817	01 03 01 01	167 g	12	pc(s)	104/162
123 041	353787	01 03 01 01	180 g	12	pc(s)	104/162
123 042	353794	01 03 01 01	122 g	12	pc(s)	104/162
123 043	353824	01 03 01 01	75 g	12	pc(s)	104/162
123 050	402454	01 06 01 01	5.66 kg	1	pc(s)	105/162
123 051	402461	01 06 01 01	8.17 kg	1	pc(s)	105/162
123 052	402478	01 06 01 01	10.68 kg	1	pc(s)	105/162
123 109	107366	01 01 01 03	340 g	1	pc(s)	110
123 110	147911	01 01 01 03	321 g	1	pc(s)	111
123 116	147966	01 01 01 03	1.11 kg	1	pc(s)	111
123 425	129009	01 01 01 03	2.82 kg	1	pc(s)	109
123 430	129016	01 01 01 03	3.22 kg	1	pc(s)	109
123 435	129023	01 01 01 03	3.42 kg	1	pc(s)	109
145 241	022584	01 01 01 04	11 kg	1	pc(s)	39
146 309	072398	01 01 01 04	864 g	1	pc(s)	39
200 027	031258	01 04 01 04	46 g	10	pc(s)	50
200 029	031265	01 04 01 04	45 g	10	pc(s)	50
200 039	129283	01 04 01 04	40 g	10	pc(s)	50
200 057	041530	01 04 01 04	30 g	25	pc(s)	50
200 059	041547	01 04 01 04	26 g	25	pc(s)	50
200 067	041554	01 04 01 04	34 g	25	pc(s)	50
200 069	041561	01 04 01 04	28 g	25	pc(s)	50
200 077	082335	01 04 01 04	32 g	50	pc(s)	50
200 079	069138	01 04 01 04	49 g	50	pc(s)	50
200 087	082342	01 04 01 04	36 g	50	pc(s)	50
200 089	074729	01 04 01 04	54 g	50	pc(s)	50
200 600	098220	01 06 01 01	4 g	50	pc(s)	55/65
200 601	098237	01 06 01 01	7 g	50	pc(s)	55/65
202 000	019881	01 03 01 02	9 g	50	pc(s)	49
202 001	020474	01 03 01 02	3 g	50	pc(s)	49
202 005	022041	01 03 01 01	70 g	50	pc(s)	43
202 010	019874	01 03 01 01	159 g	50	pc(s)	36
202 015	022089	01 03 01 01	59 g	50	pc(s)	43
202 017	019904	01 03 01 01	189 g	1	pc(s)	36
202 020	020764	01 03 01 01	250 g	25	pc(s)	32
202 021	020788	01 03 01 01	264 g	1	pc(s)	32
202 027	020771	01 03 01 01	290 g	1	pc(s)	32
202 030	022362	01 03 01 01	114 g	50	pc(s)	26
202 037	019942	01 03 01 01	187 g	50	pc(s)	36

Part No.	GTIN*	PG	Weight	PU	SU	Page
202 040	019935	01 03 01 01	170 g	50	pc(s)	36
202 050	020214	01 03 01 01	137 g	25	pc(s)	36
202 060	022263	01 03 01 01	226 g	1	pc(s)	26
202 080	020276	01 03 01 01	250 g	50	pc(s)	36
202 169	105737	01 03 01 02	6 g	100	pc(s)	49
202 227	020795	01 03 01 01	290 g	25	pc(s)	32
202 829	159822	01 07 01 01	119 g	1	pc(s)	163/184
202 850	354135	01 07 01 01	201 g	25	pc(s)	149/184
202 851	354142	01 07 01 01	208 g	25	pc(s)	149/184
202 852	354159	01 07 01 01	153 g	25	pc(s)	149/184
202 853	354166	01 07 01 01	109 g	25	pc(s)	149/184
202 857	153189	01 07 01 03	127 g	1	pc(s)	208
202 860	354180	01 07 01 03	207 g	25	pc(s)	208
202 861	354197	01 07 01 03	217 g	25	pc(s)	208
202 862	354203	01 07 01 03	160 g	25	pc(s)	209
202 863	354210	01 07 01 03	115 g	25	pc(s)	209
202 900	020801	01 03 01 01	127 g	1	pc(s)	32
202 901	019928	01 03 01 01	83 g	50	pc(s)	36
202 902	020467	01 03 01 01	81 g	50	pc(s)	36
202 906	022102	01 03 01 01	32 g	50	pc(s)	43
204 001	018990	01 03 01 02	8 g	100	pc(s)	45
204 002	019195	01 03 01 02	8 g	50	pc(s)	45
204 003	019034	01 03 01 02	15 g	100	pc(s)	45
204 004	019003	01 03 01 02	15 g	50	pc(s)	45
204 006	028371	01 03 01 02	19 g	50	pc(s)	46
204 007	019188	01 03 01 02	9 g	50	pc(s)	45
204 017	019058	01 03 01 02	9 g	100	pc(s)	45
204 027	018969	01 03 01 02	12 g	100	pc(s)	45
204 029	032286	01 03 01 01	35 g	50	pc(s)	33
204 037	019331	01 03 01 02	16 g	50	pc(s)	45
204 039	032293	01 03 01 01	35 g	50	pc(s)	33
204 049	032309	01 03 01 01	40 g	50	pc(s)	37
204 059	032316	01 03 01 01	41 g	50	pc(s)	37
204 069	032675	01 03 01 01	31 g	50	pc(s)	37
204 079	032668	01 03 01 01	31 g	50	pc(s)	37
204 089	109568	01 03 01 01	67 g	1	pc(s)	34
204 107	028104	01 03 01 01	105 g	25	pc(s)	32
204 109	028098	01 03 01 01	98 g	25	pc(s)	32
204 120	085749	01 03 01 02	20 g	50	pc(s)	46
204 127	028142	01 03 01 01	110 g	25	pc(s)	32
204 129	021433	01 03 01 01	102 g	25	pc(s)	32
204 147	042513	01 03 01 01	51 g	50	pc(s)	34
204 149	042285	01 03 01 01	52 g	50	pc(s)	34
204 157	042520	01 03 01 01	83 g	50	pc(s)	34
204 159	042537	01 03 01 01	78 g	50	pc(s)	34
204 169	042551	01 03 01 01	100 g	1	pc(s)	34
204 170	072435	01 03 01 01	40 g	50	pc(s)	34
204 171	073708	01 03 01 01	38 g	50	pc(s)	34
204 177	042568	01 03 01 01	70 g	50	pc(s)	34
204 179	042575	01 03 01 01	60 g	50	pc(s)	34
204 187	042582	01 03 01 01	91 g	50	pc(s)	34
204 189	042599	01 03 01 01	83 g	50	pc(s)	34
204 197	042605	01 03 01 01	112 g	1	pc(s)	34
204 199	042278	01 03 01 01	111 g	50	pc(s)	34
204 229	035300	01 03 01 01	31 g	50	pc(s)	38
204 239	035317	01 03 01 01	31 g	50	pc(s)	38
204 247	041806	01 03 01 01	72 g	25	pc(s)	31
204 249	041790	01 03 01 01	68 g	25	pc(s)	31
204 267	035805	01 03 01 01	70 g	25	pc(s)	31
204 269	035812	01 03 01 01	64 g	25	pc(s)	31
204 359	082779	01 03 01 01	61 g	1	pc(s)	36
204 449	124837	01 03 01 01	66 g	25	pc(s)	31

Part No. / GTIN* / PG / Weight / PU / SU / Page

Part No.	GTIN*	PG	Weight	PU	SU	Page
204 469	124851	01 03 01 01	63 g	25	pc(s)	31
204 906	028456	01 03 01 01	19 g	50	pc(s)	43
204 911	030640	01 03 01 01	98 g	25	pc(s)	32
204 913	030664	01 03 01 01	108 g	25	pc(s)	32
204 916	030565	01 03 01 01	19 g	50	pc(s)	43
204 921	030589	01 03 01 01	50 g	1	pc(s)	34
204 924	030619	01 03 01 01	64 g	50	pc(s)	34
204 925	030626	01 03 01 01	90 g	50	pc(s)	34
204 935	029958	01 03 01 01	40 g	1	pc(s)	33
204 936	029927	01 03 01 01	40 g	50	pc(s)	33
204 937	029941	01 03 01 01	46 g	50	pc(s)	33
204 938	029989	01 03 01 01	47 g	50	pc(s)	33
204 949	129290	01 03 01 01	54 g	50	pc(s)	33
204 957	129269	01 03 01 01	55 g	50	pc(s)	33

206 049	242982	01 03 01 01	25 g	50	pc(s)	37
206 105	083189	01 03 01 01	74 g	50	pc(s)	43
206 109	042810	01 03 01 01	110 g	25	pc(s)	32
206 170	082816	01 03 01 01	51 g	50	pc(s)	35
206 171	089488	01 03 01 01	51 g	50	pc(s)	35
206 207	054257	01 03 01 01	65 g	50	pc(s)	35
206 209	042759	01 03 01 01	59 g	50	pc(s)	35
206 217	052208	01 03 01 01	93 g	50	pc(s)	35
206 219	042766	01 03 01 01	83 g	50	pc(s)	35
206 227	054264	01 03 01 01	117 g	1	pc(s)	35
206 229	042773	01 03 01 01	114 g	50	pc(s)	35
206 237	077300	01 03 01 01	81 g	25	pc(s)	31
206 239	042650	01 03 01 01	74 g	25	pc(s)	31
206 247	078574	01 03 01 01	92 g	25	pc(s)	31
206 249	042803	01 03 01 01	80 g	25	pc(s)	31
206 289	149427	01 03 01 01	76 g	50	pc(s)	35
206 309	042780	01 03 01 01	60 g	50	pc(s)	35
206 319	042667	01 03 01 01	87 g	50	pc(s)	35
206 329	042797	01 03 01 01	110 g	50	pc(s)	35
206 339	047730	01 03 01 01	27 g	50	pc(s)	43
206 349	047716	01 03 01 01	48 g	50	pc(s)	38
206 359	047723	01 03 01 01	65 g	50	pc(s)	36
206 369	086494	01 03 01 01	50 g	50	pc(s)	38
206 389	109544	01 03 01 01	62 g	50	pc(s)	37
206 399	109551	01 03 01 01	63 g	50	pc(s)	37
206 439	124875	01 03 01 01	72 g	25	pc(s)	31
206 449	124899	01 03 01 01	78 g	25	pc(s)	31
206 807	046306	01 03 01 01	107 g	25	pc(s)	32
206 809	077485	01 03 01 01	114 g	25	pc(s)	32
206 817	078581	01 03 01 01	122 g	25	pc(s)	32
206 819	077362	01 03 01 01	115 g	25	pc(s)	32

207 007	054899	01 03 01 02	16 g	50	pc(s)	45
207 009	054882	01 03 01 02	16 g	50	pc(s)	45
207 017	054905	01 03 01 02	16 g	50	pc(s)	45
207 019	054912	01 03 01 02	20 g	50	pc(s)	45
207 027	042728	01 03 01 02	26 g	50	pc(s)	45
207 029	042711	01 03 01 02	24 g	50	pc(s)	45
207 037	042742	01 03 01 02	26 g	50	pc(s)	45
207 039	042735	01 03 01 02	24 g	50	pc(s)	45
207 107	235649	01 03 01 02	30 g	50	pc(s)	45
207 109	085800	01 03 01 02	27 g	50	pc(s)	45

216 000	020054	01 03 01 01	74 g	25	pc(s)	33
---------	--------	-------------	------	----	-------	----

223 005	099937	01 03 01 03	481 g	1	pc(s)	112
223 010	092778	01 03 01 01	184 g	50	pc(s)	41
223 011	092785	01 03 01 01	167 g	50	pc(s)	41

Part No.	GTIN*	PG	Weight	PU	SU	Page
223 020	092792	01 03 01 01	121 g	50	pc(s)	42
223 021	092808	01 03 01 01	103 g	50	pc(s)	42
223 031	092815	01 03 01 01	117 g	50	pc(s)	41
223 040	096752	01 03 01 01	100 g	50	pc(s)	41
223 041	096769	01 03 01 01	96 g	50	pc(s)	41
223 070	108738	01 03 01 01	103 g	50	pc(s)	41

239 000	022621	01 01 01 04	4.70 kg	1	pc(s)	39
239 001	022638	01 01 01 04	5.17 kg	1	pc(s)	39
239 009	072350	01 01 01 04	4.04 kg	1	pc(s)	39
239 019	093560	01 01 01 04	5.20 kg	1	pc(s)	39

240 000	022614	01 01 01 04	1.50 kg	1	pc(s)	39
---------	--------	-------------	---------	---	-------	----

241 009	072985	01 01 01 04	440 g	20	pc(s)	39
---------	--------	-------------	-------	----	-------	----

250 000	023871	01 03 01 02	30 g	50	pc(s)	46
250 001	023888	01 03 01 02	29 g	50	pc(s)	46
250 007	023895	01 03 01 02	29 g	50	pc(s)	46

251 002	095779	01 04 01 02	135 g	50	pc(s)	84
251 027	096394	01 04 01 02	148 g	1	pc(s)	84

252 000	023963	01 03 01 03	45 g	50	pc(s)	63
---------	--------	-------------	------	----	-------	----

253 015	022201	01 03 01 01	1.05 kg	10	pc(s)	25 / 181
253 021	022256	01 03 01 01	6 g	50	pc(s)	26
253 023	022249	01 03 01 01	8 g	50	pc(s)	25
253 025	053984	01 03 01 01	6 g	50	pc(s)	26
253 026	100169	01 07 01 01	8 g	50	pc(s)	147 / 181
253 027	110427	01 07 01 01	8 g	50	pc(s)	181
253 030	054271	01 03 01 01	58 g	100	pc(s)	25
253 050	079687	01 03 01 01	1.04 kg	10	pc(s)	25
253 051	079823	01 03 01 01	38 g	100	pc(s)	25
253 060	081628	01 03 01 01	1.04 kg	10	pc(s)	25
253 115	129870	01 03 01 01	4.82 kg	24	pc(s)	122
253 125	129887	01 03 01 01	4.84 kg	24	pc(s)	122
253 229	159846	01 07 01 01	4.89 kg	1	pc(s)	147 / 181
253 239	159853	01 07 01 01	8.70 kg	1	pc(s)	147 / 182
253 279	159877	01 07 01 01	178 g	1	pc(s)	148 / 182
253 289	159860	01 07 01 01	89 g	1	pc(s)	147 / 182
253 300	129771	01 03 01 01	165 g	24	pc(s)	122 / 205
253 301	129788	01 03 01 01	4.60 kg	24	pc(s)	122 / 205
253 302	129764	01 03 01 01	9 g	24	pc(s)	122
253 310	129795	01 03 01 01	470 g	10	pc(s)	122
253 315	129801	01 03 01 01	54 g	24	pc(s)	111 / 122
253 325	129863	01 03 01 01	75 g	24	pc(s)	111 / 122
253 330	153585	01 07 01 03	96 g	1	pc(s)	205
253 331	155206	01 07 01 03	180 g	25	pc(s)	205
253 333	153578	01 07 01 03	4.74 kg	24	pc(s)	204
253 334	154933	01 07 01 03	8.59 kg	1	pc(s)	204

260 106	023512	01 03 01 03	112 g	50	pc(s)	62
260 108	023413	01 03 01 02	96 g	50	pc(s)	48
260 118	023796	01 03 01 02	52 g	50	pc(s)	49
260 158	023420	01 03 01 02	117 g	1	pc(s)	48
260 187	023475	01 03 01 02	101 g	1	pc(s)	48
260 708	023406	01 03 01 02	80 g	50	pc(s)	48

262 070	023628	01 03 01 02	88 g	50	pc(s)	48
262 100	023635	01 03 01 02	97 g	50	pc(s)	48

273 019	031487	01 03 01 02	22 g	50	pc(s)	49
---------	--------	-------------	------	----	-------	----

Part No. / GTIN* / PG / Weight / PU / SU / Page

Part No.	GTIN*	PG	Weight	PU	SU	Page
273 731	096691	01 03 01 03	146 g	1	pc(s)	62
273 740	096714	01 03 01 02	111 g	50	pc(s)	49/61
273 741	096721	01 03 01 02	123 g	50	pc(s)	49/61
273 742	096738	01 03 01 02	145 g	1	pc(s)	49/61
274 030	130340	01 03 01 02	34 g	50	pc(s)	53/63
274 110	123434	01 03 01 02	30 g	50	pc(s)	46/59
274 113	123403	01 03 01 02	36 g	50	pc(s)	47/59
274 116	123410	01 03 01 03	37 g	50	pc(s)	61/97
274 117	128194	01 03 01 02	30 g	50	pc(s)	46/59
274 150	128187	01 03 01 02	33 g	50	pc(s)	46/59
274 160	123380	01 03 01 02	40 g	50	pc(s)	47/221
274 167	128200	01 03 01 02	41 g	50	pc(s)	47/59
274 230	130456	01 03 01 02	45 g	50	pc(s)	53/63
274 260	123489	01 03 01 03	48 g	50	pc(s)	61/97
275 019	031494	01 03 01 03	31 g	50	pc(s)	63
275 030	095847	01 03 01 02	87 g	50	pc(s)	54/64
275 110	095793	01 03 01 02	65 g	50	pc(s)	47/60
275 113	095816	01 03 01 02	82 g	50	pc(s)	48/60
275 116	095823	01 03 01 03	96 g	50	pc(s)	62
275 129	106758	01 07 01 01	21 g	10	pc(s)	218
275 160	095809	01 03 01 02	76 g	50	pc(s)	47/60
275 220	103450	01 07 01 01	17 g	25	pc(s)	150/218
275 225	103467	01 07 01 01	17 g	25	pc(s)	186
275 229	102040	01 07 01 01	59 g	50	pc(s)	186/218
275 230	095854	01 03 01 02	94 g	50	pc(s)	54/64
275 239	115811	01 07 01 01	73 g	1	pc(s)	186
275 240	152335	01 07 01 03	53 g	25	pc(s)	207
275 241	152342	01 07 01 03	53 g	25	pc(s)	207
275 242	152359	01 07 01 03	52 g	25	pc(s)	207
275 249	152366	01 07 01 03	56 g	25	pc(s)	207
275 250	155602	01 07 01 01	46 g	25	pc(s)	150/185
275 251	155619	01 07 01 01	46 g	25	pc(s)	150/185
275 252	155626	01 07 01 01	46 g	25	pc(s)	150/185
275 259	155633	01 07 01 01	49 g	25	pc(s)	150/185
275 260	095830	01 03 01 03	100 g	50	pc(s)	62
275 319	229952	01 07 01 01	124 g	10	pc(s)	185
275 320	099876	01 07 01 01	250 g	1	pc(s)	184
275 330	105065	01 07 01 01	218 g	1	pc(s)	184
275 333	105072	01 07 01 01	220 g	1	pc(s)	184
275 339	223332	01 07 01 01	247 g	1	pc(s)	207
275 359	223271	01 07 01 01	131 g	1	pc(s)	207
275 440	146914	01 07 01 01	152 g	10	pc(s)	186
275 441	146921	01 07 01 01	240 g	10	pc(s)	187
275 442	146938	01 07 01 01	250 g	10	pc(s)	187
275 444	244252	01 07 01 01	158 g	10	pc(s)	187
275 450	244436	01 07 01 01	168 g	10	pc(s)	209
275 451	244498	01 07 01 01	273 g	10	pc(s)	209
275 454	244504	01 07 01 01	173 g	10	pc(s)	210
275 455	244535	01 07 01 01	277 g	10	pc(s)	210
275 498	146945	01 07 01 01	320 g	10	pc(s)	187/209
275 711	124233	01 03 01 02	37 g	50	pc(s)	52
275 716	124226	01 03 01 03	40 g	50	pc(s)	52
275 730	124219	01 03 01 02	42 g	50	pc(s)	52
276 006	023291	01 03 01 02	2 g	100	pc(s)	48
276 007	028166	01 03 01 02	2 g	100	pc(s)	48
276 009	083318	01 03 01 02	8 g	100	pc(s)	48
276 016	123373	01 03 01 02	3 g	100	pc(s)	48
276 017	126596	01 03 01 02	3 g	100	pc(s)	48
276 056	104983	01 06 01 01	2 g	100	pc(s)	21
276 057	104990	01 06 01 01	2 g	1	pc(s)	21

Part No.	GTIN*	PG	Weight	PU	SU	Page
277 130	022669	01 03 01 02	28 g	50	pc(s)	278
277 230	110984	01 05 01 04	120 g	25	pc(s)	54/278
277 237	110991	01 05 01 04	126 g	25	pc(s)	54/278
277 239	111004	01 05 01 04	117 g	25	pc(s)	54/278
277 240	022577	01 05 01 04	167 g	25	pc(s)	54/278
284 030	022485	01 03 01 02	54 g	100	pc(s)	53/64
284 040	022492	01 03 01 02	65 g	100	pc(s)	53/64
286 030	022508	01 03 01 02	60 g	50	pc(s)	53/64
286 139	035393	01 03 01 02	45 g	50	pc(s)	53/64
286 819	085824	01 03 01 02	70 g	50	pc(s)	47/60
290 001	027909	03 01 01 01	326 g	25	pc(s)	244
290 002	027893	03 01 01 01	89 g	50	pc(s)	244
297 015	023383	01 03 01 01	131 g	25	pc(s)	26
297 025	023390	01 03 01 01	5 g	100	pc(s)	26
297 110	100886	01 03 01 01	32 g	50	pc(s)	42
297 120	100916	01 03 01 01	40 g	50	pc(s)	42
297 199	107526	01 50 01 03	864 g/l	1	liter	42
300 002	024052	01 04 01 02	115 g	25	pc(s)	51/76
300 017	024069	01 04 01 02	154 g	1	pc(s)	51/76
301 000	067035	01 04 01 02	61 g	100	pc(s)	51/75
301 007	021358	01 04 01 02	75 g	1	pc(s)	51/75
301 009	081284	01 04 01 02	61 g	100	pc(s)	51/75
301 010	067028	01 04 01 02	61 g	100	pc(s)	51/282
301 017	053502	01 04 01 02	79 g	1	pc(s)	51/282
301 019	081277	01 04 01 02	63 g	100	pc(s)	51/75
301 089	304161	01 04 01 02	61 g	100	pc(s)	51/75
301 099	304178	01 04 01 02	63 g	100	pc(s)	51/75
301 209	158252	01 04 01 02	59 g	1	pc(s)	94/281
301 229	101562	01 07 01 01	167 g	1	pc(s)	52/282
302 010	134904	01 04 01 01	137 g	50	pc(s)	52/76
305 000	041936	01 04 01 01	146 g	50	pc(s)	77
305 007	052307	01 04 01 01	151 g	50	pc(s)	77
306 020	096264	01 04 01 01	145 g	50	pc(s)	77
306 029	129467	01 04 01 01	120 g	50	pc(s)	77
306 100	024113	01 04 01 01	238 g	25	pc(s)	77
306 101	024120	01 04 01 01	412 g	25	pc(s)	77
306 105	269125	01 05 01 05	242 g	1	pc(s)	280
306 106	269149	01 05 01 05	420 g	1	pc(s)	280
306 121	284920	03 01 01 01	161 g	50	pc(s)	77/241
306 122	284937	03 01 01 01	165 g	50	pc(s)	77/241
306 200	327368	01 05 01 05	74 g	50	pc(s)	284
306 201	327375	01 05 01 05	74 g	50	pc(s)	284
306 202	327351	01 05 01 05	71 g	50	pc(s)	284
306 203	327382	01 05 01 05	74 g	50	pc(s)	284
306 204	336766	01 05 01 05	75 g	50	pc(s)	284
306 205	336773	01 05 01 05	73 g	50	pc(s)	284
306 206	336780	01 05 01 05	71 g	50	pc(s)	284
306 210	327399	01 05 01 05	356 g	15	pc(s)	284
306 211	327405	01 05 01 05	340 g	15	pc(s)	284
306 212	327412	01 05 01 05	314 g	15	pc(s)	285
306 213	327429	01 05 01 05	392 g	15	pc(s)	285
306 220	327436	01 05 01 05	394 g	50	pc(s)	285
306 230	327443	01 05 01 05	11 g	10	pc(s)	285
306 231	327450	01 05 01 05	11 g	10	pc(s)	285

Part No. / GTIN* / PG / Weight / PU / SU / Page

Part No.	GTIN*	PG	Weight	PU	SU	Page
306 240	327467	01 05 01 05	2 g	20	pc(s)	285
307 000	024151	01 04 01 01	105 g	50	pc(s)	77
307 007	024168	01 04 01 01	104 g	1	pc(s)	77
308 001	027947	03 01 01 01	216 g	25	pc(s)	244
308 025	035881	03 01 01 01	100 g	50	pc(s)	135/240
308 026	035874	03 01 01 01	107 g	25	pc(s)	135/240
308 030	030749	03 01 01 01	125 g	50	pc(s)	135/240
308 031	136571	03 01 01 01	230 g	25	pc(s)	137/242
308 032	152823	03 01 01 01	169 g	25	pc(s)	137/242
308 035	123472	03 01 01 01	165 g	25	pc(s)	131/240
308 036	136588	03 01 01 01	266 g	25	pc(s)	137/242
308 037	154704	03 01 01 01	208 g	25	pc(s)	137/242
308 040	055902	03 01 01 01	450 g	20	pc(s)	75/241
308 041	056411	03 01 01 01	471 g	20	pc(s)	75/241
308 045	124455	03 01 01 01	262 g	25	pc(s)	135/240
308 046	124462	03 01 01 01	288 g	25	pc(s)	131/241
308 060	066281	03 01 01 01	138 g	50	pc(s)	82
308 062	344051	03 01 01 01	156 g	50	pc(s)	81/243
308 070	066298	03 01 01 01	197 g	1	pc(s)	82
308 120	099258	03 01 01 01	134 g	25	pc(s)	137/242
308 129	099265	03 01 01 01	131 g	25	pc(s)	137/242
308 130	288942	03 01 01 01	18 g	50	pc(s)	134/239
308 131	288881	03 01 01 01	18 g	50	pc(s)	134/239
308 132	288423	03 01 01 01	20 g	50	pc(s)	134/239
308 133	288911	03 01 01 01	20 g	50	pc(s)	134/239
308 134	308091	03 01 01 01	18 g	50	pc(s)	134/239
308 135	308107	03 01 01 01	18 g	50	pc(s)	134/239
308 136	308114	03 01 01 01	18 g	50	pc(s)	134/239
308 137	308121	03 01 01 01	18 g	50	pc(s)	134/239
308 140	288935	03 01 01 01	21 g	50	pc(s)	134/239
308 141	288904	03 01 01 01	19 g	50	pc(s)	134/239
308 142	288522	03 01 01 01	18 g	50	pc(s)	134/239
308 143	289123	03 01 01 01	18 g	50	pc(s)	134/239
308 150	106970	03 01 01 01	682 g	1	pc(s)	244
308 220	084216	03 01 01 01	250 g	25	pc(s)	81/243
308 229	083745	03 01 01 01	190 g	25	pc(s)	81/243
308 230	090859	03 01 01 01	241 g	25	pc(s)	81/243
308 239	090866	03 01 01 01	197 g	25	pc(s)	81/243
308 249	129313	03 01 01 01	200 g	25	pc(s)	81/243
308 320	028531	03 01 01 01	266 g	25	pc(s)	81/243
308 329	081338	03 01 01 01	220 g	25	pc(s)	81/243
308 330	096660	03 01 01 01	266 g	25	pc(s)	82/243
309 008	024229	01 04 01 01	140 g	50	pc(s)	76
309 087	024243	01 04 01 01	99 g	50	pc(s)	76
310 008	024328	01 04 01 01	124 g	50	pc(s)	76
314 300	096400	01 04 01 01	120 g	50	pc(s)	78
314 307	096417	01 04 01 01	132 g	50	pc(s)	78
314 310	042841	01 04 01 01	174 g	50	pc(s)	78
315 119	134072	01 04 01 01	90 g	50	pc(s)	76
316 163	024502	01 04 01 01	191 g	1	pc(s)	78
316 167	035386	01 04 01 01	209 g	25	pc(s)	78
318 033	021471	03 01 01 01	236 g	25	pc(s)	80
318 201	021464	03 01 01 01	234 g	25	pc(s)	79
318 203	159914	03 01 01 01	329 g	1	pc(s)	80
318 205	159921	03 01 01 01	242 g	25	pc(s)	81

Part No.	GTIN*	PG	Weight	PU	SU	Page
318 207	021488	03 01 01 01	253 g	1	pc(s)	79
318 209	035973	03 01 01 01	245 g	25	pc(s)	79
318 219	129320	03 01 01 01	235 g	25	pc(s)	80
318 229	159938	03 01 01 01	323 g	25	pc(s)	80
318 233	096646	03 01 01 01	225 g	25	pc(s)	80
318 239	159945	03 01 01 01	240 g	25	pc(s)	81
318 251	046559	03 01 01 01	241 g	25	pc(s)	80
318 252	048454	03 01 01 01	251 g	25	pc(s)	80
319 201	024519	03 01 01 01	320 g	25	pc(s)	79
319 202	024526	03 01 01 01	333 g	25	pc(s)	79
319 207	020047	03 01 01 01	349 g	25	pc(s)	79
319 209	035980	03 01 01 01	313 g	25	pc(s)	79
319 219	069916	03 01 01 01	319 g	25	pc(s)	79
319 229	108752	03 01 01 01	409 g	25	pc(s)	79
320 044	021501	03 01 01 01	301 g	25	pc(s)	80
321 045	021518	03 01 01 01	413 g	25	pc(s)	79
321 047	021525	03 01 01 01	453 g	25	pc(s)	79
338 000	024847	01 04 01 02	171 g	25	pc(s)	86
338 001	054172	01 04 01 02	68 g	25	pc(s)	86
338 007	024854	01 04 01 02	190 g	25	pc(s)	86
338 009	057982	01 04 01 02	136 g	25	pc(s)	86
339 010	024823	01 04 01 02	195 g	25	pc(s)	87
339 050	096257	01 04 01 02	138 g	25	pc(s)	86
339 051	127388	01 04 01 02	95 g	25	pc(s)	86
339 057	096332	01 04 01 02	150 g	25	pc(s)	86
339 059	096301	01 04 01 02	132 g	25	pc(s)	86
339 060	046870	01 04 01 02	133 g	25	pc(s)	86
339 061	127395	01 04 01 02	83 g	25	pc(s)	86
339 067	046887	01 04 01 02	136 g	25	pc(s)	86
339 069	079960	01 04 01 02	122 g	25	pc(s)	86
339 100	092068	01 04 01 02	180 g	25	pc(s)	85
339 101	092082	01 04 01 02	84 g	1	pc(s)	85
339 110	092105	01 04 01 02	176 g	25	pc(s)	85
339 111	092129	01 04 01 02	92 g	25	pc(s)	85
339 157	096325	01 04 01 02	142 g	25	pc(s)	86
339 167	034426	01 04 01 02	140 g	1	pc(s)	86
343 000	024861	01 04 01 02	167 g	25	pc(s)	87
343 007	024878	01 04 01 02	180 g	1	pc(s)	87
345 008	025073	01 04 01 02	27 g	100	pc(s)	88
345 010	025080	01 04 01 02	25 g	100	pc(s)	88
347 205	136601	01 04 01 02	25 g	100	pc(s)	88
363 000	045750	01 04 01 02	66 g	50	pc(s)	132/235
363 010	045743	01 04 01 02	124 g	50	pc(s)	132/235
365 000	024731	01 04 01 02	109 g	50	pc(s)	84
365 007	024748	01 04 01 02	131 g	50	pc(s)	84
365 010	096318	01 04 01 02	107 g	50	pc(s)	84
365 017	096349	01 04 01 02	105 g	50	pc(s)	84
365 019	096295	01 04 01 02	83 g	50	pc(s)	84
365 020	035126	01 04 01 02	120 g	50	pc(s)	84
365 027	035133	01 04 01 02	146 g	50	pc(s)	84
365 030	046894	01 04 01 02	100 g	50	pc(s)	84
365 031	055438	01 04 01 02	49 g	50	pc(s)	84
365 037	046900	01 04 01 02	103 g	50	pc(s)	84

Part No. / GTIN* / PG / Weight / PU / SU / Page

Part No.	GTIN*	PG	Weight	PU	SU	Page
365 039	057777	01 04 01 02	89 g	50	pc(s)	84
365 040	069053	01 04 01 02	124 g	50	pc(s)	84
365 047	069046	01 04 01 02	139 g	1	pc(s)	84
365 050	091825	01 04 01 02	155 g	50	pc(s)	85
365 051	091832	01 04 01 02	75 g	50	pc(s)	85
365 057	091849	01 04 01 02	165 g	50	pc(s)	85
365 059	091856	01 04 01 02	134 g	50	pc(s)	41 / 85
365 117	035331	01 04 01 02	115 g	1	pc(s)	85
365 127	080317	01 04 01 02	104 g	1	pc(s)	85
365 220	096103	01 04 01 02	171 g	50	pc(s)	85
365 221	092396	01 04 01 02	91 g	50	pc(s)	85
365 227	096127	01 04 01 02	197 g	50	pc(s)	85
365 229	096110	01 04 01 02	161 g	50	pc(s)	85
365 250	148307	01 04 01 02	83 g	50	pc(s)	274
365 419	128927	01 04 01 03	458 g	5	pc(s)	30
365 509	141773	01 04 01 03	335 g	1	pc(s)	30
365 519	130869	01 04 01 03	333 g	1	pc(s)	30
370 014	096387	01 04 01 02	188 g	25	pc(s)	82
370 018	024724	01 04 01 02	290 g	25	pc(s)	82
371 007	024663	01 04 01 02	231 g	1	pc(s)	82
371 008	024670	01 04 01 02	148 g	50	pc(s)	82
371 009	024656	01 04 01 02	208 g	20	pc(s)	82
372 018	104624	01 04 01 02	158 g	25	pc(s)	83
372 019	104631	01 04 01 02	154 g	25	pc(s)	83
372 035	104648	01 04 01 02	177 g	25	pc(s)	83
372 110	119055	01 04 01 02	283 g	25	pc(s)	83
372 119	119178	01 04 01 02	277 g	25	pc(s)	83
372 120	119062	01 04 01 02	288 g	25	pc(s)	83
372 129	119185	01 04 01 02	283 g	25	pc(s)	83
372 140	119086	01 04 01 02	336 g	25	pc(s)	83
372 149	119208	01 04 01 02	326 g	25	pc(s)	83
372 150	119093	01 04 01 02	339 g	25	pc(s)	83
372 159	119215	01 04 01 02	333 g	25	pc(s)	83
372 210	119116	01 04 01 02	284 g	25	pc(s)	83
372 219	119239	01 04 01 02	278 g	25	pc(s)	83
372 220	119123	01 04 01 02	288 g	25	pc(s)	83
372 229	119246	01 04 01 02	283 g	25	pc(s)	83
372 240	119147	01 04 01 02	335 g	25	pc(s)	83
372 249	119260	01 04 01 02	326 g	1	pc(s)	83
372 250	119154	01 04 01 02	338 g	25	pc(s)	83
372 259	119277	01 04 01 02	331 g	25	pc(s)	83
374 011	030701	01 04 01 03	80 g	25	pc(s)	27
374 020	030725	01 04 01 03	37 g	50	pc(s)	27
377 005	024908	01 04 01 02	22 g	50	pc(s)	87
377 006	024922	01 04 01 03	37 g	50	pc(s)	28
377 007	092686	01 04 01 03	107 g	10	pc(s)	28
377 009	119284	01 04 01 02	52 g	50	pc(s)	87
377 015	092693	01 04 01 03	36 g	10	pc(s)	28
377 016	083417	01 04 01 03	36 g	50	pc(s)	28
377 017	024915	01 04 01 02	49 g	50	pc(s)	87
377 026	068582	01 04 01 03	45 g	50	pc(s)	28
377 027	034204	01 04 01 03	112 g	50	pc(s)	28
377 045	099296	01 04 01 03	36 g	100	pc(s)	29
377 100	078604	01 04 01 02	74 g	50	pc(s)	87
377 107	092709	01 04 01 03	172 g	10	pc(s)	29
377 115	092716	01 04 01 03	59 g	10	pc(s)	29
377 200	136465	01 04 01 02	70 g	50	pc(s)	87
377 210	083028	01 04 01 03	53 g	10	pc(s)	29

Part No.	GTIN*	PG	Weight	PU	SU	Page
377 310	033382	01 04 01 03	72 g	100	pc(s)	29
377 410	083035	01 04 01 03	90 g	10	pc(s)	29
377 510	033399	01 04 01 03	110 g	10	pc(s)	29
380 020	066373	01 04 01 01	86 g	50	pc(s)	89
380 029	066359	01 04 01 01	70 g	50	pc(s)	89
380 110	133273	01 04 01 01	100 g	50	pc(s)	88
380 116	133280	01 04 01 01	100 g	50	pc(s)	88
380 129	150416	01 04 01 02	100 g	50	pc(s)	88
380 209	158269	01 04 01 02	102 g	1	pc(s)	94 / 281
385 202	068131	01 04 01 01	69 g	50	pc(s)	78
385 203	035669	01 04 01 01	64 g	50	pc(s)	78
385 207	049093	01 04 01 01	64 g	50	pc(s)	78
385 213	090873	01 04 01 01	38 g	50	pc(s)	78
385 216	100565	01 04 01 01	133 g	10	pc(s)	89
390 050	095991	01 04 01 01	99 g	50	pc(s)	73 / 241
390 051	096219	01 04 01 01	55 g	50	pc(s)	73
390 057	096073	01 04 01 01	118 g	50	pc(s)	73
390 059	096004	01 04 01 01	92 g	50	pc(s)	73
390 060	096011	01 04 01 01	108 g	50	pc(s)	73
390 061	096196	01 04 01 01	67 g	50	pc(s)	73
390 063	159396	01 04 01 01	103 g	50	pc(s)	73
390 067	096080	01 04 01 01	122 g	50	pc(s)	73
390 079	128996	01 04 01 01	96 g	50	pc(s)	73 / 221
390 110	104921	01 04 01 02	18 g	100	pc(s)	49
390 119	104945	01 04 01 02	18 g	100	pc(s)	49
390 120	346901	01 03 01 02	12 g	50	pc(s)	49
390 121	346918	01 03 01 02	20 g	50	pc(s)	49
390 122	346925	01 03 01 02	18 g	50	pc(s)	49
390 150	032187	01 04 01 02	53 g	100	pc(s)	51 / 75
390 157	032194	01 04 01 02	53 g	1	pc(s)	51 / 75
390 159	032200	01 04 01 02	61 g	100	pc(s)	51 / 75
390 209	158245	01 04 01 01	104 g	1	pc(s)	94 / 281
390 250	031791	01 04 01 01	74 g	50	pc(s)	74
390 257	031807	01 04 01 01	78 g	50	pc(s)	74
390 259	031814	01 04 01 01	71 g	50	pc(s)	74
390 267	034402	01 04 01 01	79 g	1	pc(s)	74
390 479	035324	01 04 01 02	74 g	50	pc(s)	132 / 235
390 499	127517	01 04 01 02	57 g	50	pc(s)	132 / 235
390 550	096042	01 04 01 01	101 g	50	pc(s)	73 / 241
390 551	096202	01 04 01 01	58 g	50	pc(s)	73
390 557	096097	01 04 01 01	118 g	50	pc(s)	73
390 559	096035	01 04 01 01	98 g	50	pc(s)	73
390 565	385313	01 04 01 01	50 g	50	pc(s)	74
390 657	096165	01 04 01 01	100 g	50	pc(s)	74
391 050	087064	01 04 01 01	101 g	50	pc(s)	73 / 241
391 059	087071	01 04 01 01	98 g	50	pc(s)	73
391 060	088009	01 04 01 01	113 g	50	pc(s)	73
391 069	087095	01 04 01 01	106 g	50	pc(s)	73
391 550	088016	01 04 01 01	105 g	50	pc(s)	73
391 559	087088	01 04 01 01	100 g	50	pc(s)	73
392 050	096066	01 04 01 01	121 g	50	pc(s)	74 / 89
392 059	096059	01 04 01 01	119 g	50	pc(s)	74 / 89
392 060	096141	01 04 01 01	130 g	50	pc(s)	74 / 89
392 069	096158	01 04 01 01	126 g	50	pc(s)	74 / 89
392 209	158238	01 04 01 01	140 g	1	pc(s)	94 / 281
393 069	094079	01 04 01 01	150 g	50	pc(s)	120

Part No.	GTIN*	PG	Weight	PU	SU	Page
405 020	098459	01 07 01 01	81 g	1	pc(s)	183
407 012	026100	01 05 01 02	432 g	10	pc(s)	273
407 034	026117	01 05 01 02	443 g	10	pc(s)	273
407 100	026124	01 05 01 02	457 g	10	pc(s)	273
407 112	026148	01 05 01 02	502 g	10	pc(s)	273
407 114	026131	01 05 01 02	480 g	10	pc(s)	273
407 200	026162	01 05 01 02	556 g	1	pc(s)	273
410 003	028722	03 07 01 01	105 g	1	pc(s)	255
410 005	028715	03 07 01 01	120 g	1	pc(s)	255
410 006	028708	03 07 01 01	140 g	1	pc(s)	255
410 010	028692	03 07 01 01	190 g	1	pc(s)	255
410 012	026186	01 05 01 02	234 g	25	pc(s)	274
410 015	028685	03 07 01 01	248 g	1	pc(s)	255
410 020	028678	03 07 01 01	300 g	1	pc(s)	255
410 025	028661	03 07 01 01	370 g	1	pc(s)	255
410 030	028654	03 07 01 01	438 g	1	pc(s)	255
410 034	026247	01 05 01 02	231 g	25	pc(s)	274
410 035	028647	03 07 01 01	490 g	1	pc(s)	255
410 038	026223	01 05 01 02	211 g	25	pc(s)	274
410 040	028630	03 07 01 01	550 g	1	pc(s)	255
410 050	028623	03 07 01 01	680 g	1	pc(s)	255
410 060	028616	03 07 01 01	800 g	1	pc(s)	255
410 070	028609	03 07 01 01	920 g	1	pc(s)	255
410 099	028593	03 07 01 01	1.27 kg	1	pc(s)	255
410 100	026254	01 05 01 02	246 g	25	pc(s)	274
410 112	026278	01 05 01 02	296 g	25	pc(s)	274
410 114	026261	01 05 01 02	276 g	25	pc(s)	274
410 134	026285	01 05 01 02	312 g	1	pc(s)	274
410 140	028586	03 07 01 01	1.78 kg	1	pc(s)	255
410 150	028579	03 07 01 01	1.87 kg	1	pc(s)	255
410 199	028562	03 07 01 01	2.48 kg	1	pc(s)	255
410 200	026292	01 05 01 02	324 g	25	pc(s)	274
410 212	026308	01 05 01 02	402 g	1	pc(s)	274/276
410 219	118829	01 07 01 02	74 g	1	pc(s)	144
410 229	107731	01 07 01 01	72 g	1	pc(s)	174
410 239	152465	01 07 01 01	80 g	1	pc(s)	198
410 299	028555	03 07 01 01	3.66 kg	1	pc(s)	255
410 300	026315	01 05 01 02	416 g	1	pc(s)	274/276
410 309	081451	01 05 01 02	180 g	1	pc(s)	274
410 319	081505	01 05 01 02	188 g	25	pc(s)	274
410 329	081512	01 05 01 02	192 g	25	pc(s)	274
410 339	081550	01 05 01 02	206 g	25	pc(s)	274
410 349	081604	01 05 01 02	232 g	1	pc(s)	274
410 359	081468	01 05 01 02	248 g	1	pc(s)	274
410 369	081529	01 05 01 02	260 g	25	pc(s)	274
410 379	081475	01 05 01 02	272 g	1	pc(s)	274
410 389	081482	01 05 01 02	315 g	1	pc(s)	274
410 399	081499	01 05 01 02	360 g	1	pc(s)	274
410 401	029200	03 07 01 01	90 g	1	pc(s)	258
410 403	029194	03 07 01 01	109 g	1	pc(s)	258
410 404	029187	03 07 01 01	122 g	1	pc(s)	258
410 405	029262	03 07 01 01	140 g	1	pc(s)	258
410 406	029163	03 07 01 01	147 g	1	pc(s)	258
410 407	029255	03 07 01 01	145 g	1	pc(s)	258
410 410	029248	03 07 01 01	200 g	1	pc(s)	258
410 411	029156	03 07 01 01	197 g	1	pc(s)	258
410 413	029279	03 07 01 01	110 g	1	pc(s)	258
410 415	029149	03 07 01 01	261 g	1	pc(s)	258
410 416	029231	03 07 01 01	250 g	1	pc(s)	258
410 420	029132	03 07 01 01	320 g	1	pc(s)	258
410 421	029224	03 07 01 01	320 g	1	pc(s)	258

Part No.	GTIN*	PG	Weight	PU	SU	Page
410 425	029125	03 07 01 01	385 g	1	pc(s)	258
410 426	029217	03 07 01 01	370 g	1	pc(s)	258
410 430	029118	03 07 01 01	445 g	1	pc(s)	258
410 431	029590	03 07 01 01	430 g	1	pc(s)	258
410 450	029170	03 07 01 01	135 g	1	pc(s)	258
410 503	029408	03 07 01 01	100 g	1	pc(s)	257
410 506	029415	03 07 01 01	116 g	1	pc(s)	257
410 510	029422	03 07 01 01	185 g	1	pc(s)	257
410 515	029439	03 07 01 01	250 g	1	pc(s)	257
410 520	029446	03 07 01 01	300 g	1	pc(s)	257
410 525	029453	03 07 01 01	365 g	1	pc(s)	257
410 530	029460	03 07 01 01	425 g	1	pc(s)	257
410 603	029330	03 07 01 01	100 g	1	pc(s)	255
410 605	029347	03 07 01 01	120 g	1	pc(s)	255
410 606	029491	03 07 01 01	114 g	1	pc(s)	260
410 610	029354	03 07 01 01	185 g	1	pc(s)	255
410 615	029361	03 07 01 01	240 g	1	pc(s)	255
410 620	029378	03 07 01 01	305 g	1	pc(s)	255
410 625	029385	03 07 01 01	365 g	1	pc(s)	255
410 630	029392	03 07 01 01	430 g	1	pc(s)	255
410 720	032415	03 07 01 01	292 g	1	pc(s)	260
410 903	029033	03 07 01 01	110 g	1	pc(s)	259
410 905	029040	03 07 01 01	140 g	1	pc(s)	259
410 906	029057	03 07 01 01	140 g	1	pc(s)	259
410 910	029064	03 07 01 01	200 g	1	pc(s)	259
410 915	029071	03 07 01 01	260 g	1	pc(s)	259
410 920	029088	03 07 01 01	320 g	1	pc(s)	259
410 925	029095	03 07 01 01	380 g	1	pc(s)	259
410 930	029101	03 07 01 01	440 g	1	pc(s)	259
416 003	028937	03 07 01 01	126 g	1	pc(s)	256
416 005	028920	03 07 01 01	165 g	1	pc(s)	256
416 006	028913	03 07 01 01	184 g	1	pc(s)	256
416 010	028906	03 07 01 01	262 g	1	pc(s)	256
416 015	028890	03 07 01 01	360 g	1	pc(s)	256
416 016	029484	03 07 01 01	340 g	1	pc(s)	260
416 020	028883	03 07 01 01	460 g	1	pc(s)	256
416 025	028876	03 07 01 01	545 g	1	pc(s)	256
416 030	028869	03 07 01 01	650 g	1	pc(s)	256
416 035	028852	03 07 01 01	748 g	1	pc(s)	256
416 040	028845	03 07 01 01	830 g	1	pc(s)	256
416 050	028838	03 07 01 01	1.04 kg	1	pc(s)	256
416 060	028821	03 07 01 01	1.24 kg	1	pc(s)	256
416 070	028814	03 07 01 01	1.44 kg	1	pc(s)	256
416 080	028807	03 07 01 01	1.60 kg	1	pc(s)	256
416 100	042933	03 07 01 01	2.01 kg	1	pc(s)	256
416 120	028791	03 07 01 01	2.43 kg	1	pc(s)	256
416 140	028784	03 07 01 01	2.73 kg	1	pc(s)	256
416 150	028777	03 07 01 01	3.01 kg	1	pc(s)	256
416 200	028760	03 07 01 01	3.95 kg	1	pc(s)	256
416 220	028753	03 07 01 01	4.38 kg	1	pc(s)	256
416 280	028746	03 07 01 01	5.64 kg	1	pc(s)	256
416 300	028739	03 07 01 01	5.94 kg	1	pc(s)	256
416 403	029286	03 07 01 01	130 g	1	pc(s)	259
416 410	032422	03 07 01 01	265 g	1	pc(s)	259
416 411	032545	03 07 01 01	266 g	1	pc(s)	259
416 415	032439	03 07 01 01	364 g	1	pc(s)	259
416 416	032453	03 07 01 01	364 g	1	pc(s)	259
416 420	032446	03 07 01 01	464 g	1	pc(s)	259
416 421	036116	03 07 01 01	461 g	1	pc(s)	259
416 425	032460	03 07 01 01	558 g	1	pc(s)	259
416 426	032477	03 07 01 01	558 g	1	pc(s)	259
416 430	032484	03 07 01 01	654 g	1	pc(s)	259

Part No. / GTIN* / PG / Weight / PU / SU / Page

Part No.	GTIN*	PG	Weight	PU	SU	Page
416 431	032491	03 07 01 01	655 g	1	pc(s)	259
416 440	032507	03 07 01 01	849 g	1	pc(s)	259
416 441	032514	03 07 01 01	849 g	1	pc(s)	259
416 450	032521	03 07 01 01	1.04 kg	1	pc(s)	259
416 451	032538	03 07 01 01	1.04 kg	1	pc(s)	259
416 505	029477	03 07 01 01	158 g	1	pc(s)	258
416 516	032408	03 07 01 01	341 g	1	pc(s)	256
416 903	028944	03 07 01 01	132 g	1	pc(s)	260
416 905	028951	03 07 01 01	180 g	1	pc(s)	260
416 906	028968	03 07 01 01	190 g	1	pc(s)	260
416 910	028975	03 07 01 01	265 g	1	pc(s)	260
416 915	028982	03 07 01 01	365 g	1	pc(s)	260
416 920	028999	03 07 01 01	455 g	1	pc(s)	260
416 925	029002	03 07 01 01	550 g	1	pc(s)	260
416 930	029019	03 07 01 01	660 g	1	pc(s)	260
416 970	029026	03 07 01 01	1.46 kg	1	pc(s)	260
417 005	031982	03 07 01 01	168 g	1	pc(s)	257
417 010	031975	03 07 01 01	259 g	1	pc(s)	257
417 015	031968	03 07 01 01	353 g	1	pc(s)	257
417 020	031951	03 07 01 01	447 g	1	pc(s)	257
417 030	031944	03 07 01 01	635 g	1	pc(s)	257
417 050	031937	03 07 01 01	1.01 kg	1	pc(s)	257
417 100	031920	03 07 01 01	1.95 kg	1	pc(s)	257
417 115	031913	03 07 01 01	2.89 kg	1	pc(s)	257
417 120	031906	03 07 01 01	3.83 kg	1	pc(s)	257
417 125	031890	03 07 01 01	4.77 kg	1	pc(s)	257
417 130	031883	03 07 01 01	5.71 kg	1	pc(s)	257
417 150	031876	03 07 01 01	9.47 kg	1	pc(s)	257
420 100	022805	01 04 01 04	137 g	50	pc(s)	50/276
420 107	045828	01 04 01 04	158 g	1	pc(s)	50/276
420 120	022829	01 04 01 04	160 g	1	pc(s)	50/276
420 127	045804	01 04 01 04	186 g	1	pc(s)	50/276
420 207	045873	01 04 01 04	215 g	1	pc(s)	50/277
423 010	054325	01 04 01 04	113 g	50	pc(s)	50/277
423 011	054332	01 04 01 04	48 g	50	pc(s)	50/277
423 017	054349	01 04 01 04	119 g	1	pc(s)	50/277
423 019	054356	01 04 01 04	109 g	50	pc(s)	50/277
423 020	054288	01 04 01 04	138 g	50	pc(s)	50/277
423 021	054295	01 04 01 04	61 g	50	pc(s)	50/277
423 027	054301	01 04 01 04	156 g	50	pc(s)	50/277
423 029	054318	01 04 01 04	151 g	50	pc(s)	50/277
425 076	022683	01 04 01 04	208 g	50	pc(s)	276
425 089	022706	01 04 01 04	231 g	1	pc(s)	276
435 803	029781	03 07 01 01	468 g	1	pc(s)	262
435 805	029798	03 07 01 01	317 g	1	pc(s)	261
444 006	029323	03 07 01 01	29 g	100	pc(s)	261
444 008	029293	03 07 01 01	36 g	1	pc(s)	261
444 009	029309	03 07 01 01	36 g	1	pc(s)	261
444 010	029316	03 07 01 01	34 g	100	pc(s)	261
444 050	291218	03 07 01 01	24 g/Sa	1	Sa	145/204
450 000	025158	01 04 01 03	122 g	50	pc(s)	93
450 001	090903	01 04 01 03	62 g	50	pc(s)	93
450 007	025165	01 04 01 03	133 g	1	pc(s)	93
450 011	025172	01 04 01 03	134 g	50	pc(s)	93
450 101	094093	01 04 01 03	44 g	50	pc(s)	93

Part No.	GTIN*	PG	Weight	PU	SU	Page
453 100	025523	01 04 01 03	333 g	10	pc(s)	66
454 000	025387	01 04 01 03	261 g	25	pc(s)	93
454 100	035904	01 04 01 03	177 g	25	pc(s)	92
454 107	035911	01 04 01 03	198 g	25	pc(s)	92
455 000	025394	01 04 01 03	250 g	1	pc(s)	93
459 000	025189	01 04 01 03	127 g	50	pc(s)	91
459 003	025202	01 04 01 03	126 g	50	pc(s)	91
459 010	099838	01 04 01 03	110 g	1	pc(s)	92
459 019	031272	01 04 01 03	87 g	50	pc(s)	92
459 020	099845	01 04 01 03	103 g	50	pc(s)	92
459 029	047587	01 04 01 03	87 g	50	pc(s)	92
459 030	099852	01 04 01 03	101 g	50	pc(s)	92
459 039	047594	01 04 01 03	88 g	50	pc(s)	92
459 119	051379	01 04 01 03	124 g	50	pc(s)	91
459 127	119291	01 04 01 03	152 g	1	pc(s)	90
459 129	051386	01 04 01 03	120 g	50	pc(s)	90/221
459 139	078628	01 04 01 03	122 g	50	pc(s)	91
459 159	152830	01 04 01 03	122 g	50	pc(s)	92
459 200	155527	01 04 01 03	132 g	1	pc(s)	94/281
459 219	158221	01 04 01 03	126 g	1	pc(s)	94/281
460 147	025349	01 04 01 03	340 g	1	pc(s)	93
460 213	034358	01 04 01 03	166 g	50	pc(s)	92
460 507	034266	01 04 01 03	126 g	1	pc(s)	91
460 517	034259	01 04 01 03	105 g	1	pc(s)	91
460 557	034242	01 04 01 03	80 g	1	pc(s)	91
463 010	025493	01 04 01 03	138 g	50	pc(s)	76
465 801	030091	03 07 01 01	321 g	1	pc(s)	263
466 192	030084	03 07 01 01	550 g	1	pc(s)	263
466 203	033009	03 07 01 01	813 g	1	pc(s)	263
472 021	027879	01 05 01 03	866 g	1	pc(s)	271
472 022	030305	01 05 01 03	588 g	1	pc(s)	270
472 023	030312	01 05 01 03	517 g	1	pc(s)	270
472 024	034495	01 05 01 03	677 g	1	pc(s)	271
472 109	074477	01 05 01 03	604 g	1	pc(s)	270
472 119	074484	01 05 01 03	740 g	1	pc(s)	270
472 129	074491	01 05 01 03	841 g	1	pc(s)	271
472 139	074507	01 05 01 03	1.10 kg	1	pc(s)	271
472 201	089631	01 06 01 01	66 g	1	pc(s)	269/283
472 202	147331	01 06 01 01	70 g	1	pc(s)	269/283
472 207	090927	01 05 01 03	964 g	1	pc(s)	268/282
472 209	090934	01 05 01 03	1.01 kg	1	pc(s)	268/282
472 210	096790	01 50 50 01	92 g	1	pc(s)	269/283
472 217	090941	01 05 01 03	1.35 kg	1	pc(s)	268/283
472 219	090958	01 05 01 03	1.41 kg	1	pc(s)	268/283
472 227	096424	01 05 01 03	1.14 kg	1	pc(s)	268/282
472 229	096431	01 05 01 03	1.18 kg	1	pc(s)	268/282
472 237	096448	01 05 01 03	1.53 kg	1	pc(s)	268/283
472 239	096455	01 05 01 03	1.59 kg	1	pc(s)	268/283
472 269	096462	01 05 01 03	322 g	1	pc(s)	269/283
472 279	090972	01 05 01 03	285 g	1	pc(s)	269/283
472 289	090989	01 05 01 03	366 g	1	pc(s)	269/283
472 299	096479	01 05 01 03	403 g	1	pc(s)	269/283
472 309	157170	01 05 01 03	226 g	1	pc(s)	269
472 319	157187	01 05 01 03	267 g	1	pc(s)	269
472 329	157194	01 05 01 03	307 g	1	pc(s)	270

Part No.	GTIN*	PG	Weight	PU	SU	Page
472 339	157200	01 05 01 03	348 g	1	pc(s)	270
472 349	157217	01 05 01 03	387 g	1	pc(s)	270
476 001	028548	01 04 01 03	468 g	10	pc(s)	68
476 010	025578	01 04 01 03	797 g	1	pc(s)	67
476 016	125216	01 04 01 03	559 g	1	pc(s)	67
476 020	126916	01 04 01 03	800 g	1	pc(s)	68
476 050	219717	01 04 01 03	869 g	1	pc(s)	68
476 053	219724	01 04 01 03	185 g	1	pc(s)	68
476 055	219755	01 04 01 03	1.02 kg	1	pc(s)	68
476 100	086470	01 04 01 03	460 g	10	pc(s)	68
478 011	033054	01 05 01 01	301 g	10	pc(s)	129/233
478 012	069183	01 05 01 01	182 g	10	pc(s)	129/233
478 019	072107	01 05 01 01	299 g	10	pc(s)	129/233
478 027	125995	01 05 01 01	603 g	1	pc(s)	130/234
478 041	105157	01 05 01 01	304 g	10	pc(s)	129/233
478 049	105164	01 05 01 01	303 g	10	pc(s)	129/233
478 051	124448	01 05 01 01	370 g	1	pc(s)	129/233
478 098	337411	01 05 01 01	8 g	10	pc(s)	130/234
478 099	120334	01 06 01 01	52 g	20	pc(s)	21/231
478 112	118140	01 05 01 01	276 g	10	pc(s)	130/233
478 129	118508	01 05 01 01	140 g	10	pc(s)	133/236
478 141	101425	01 05 01 01	338 g	10	pc(s)	133/236
478 149	154964	01 05 01 01	390 g	10	pc(s)	133/236
478 150	359512	01 05 01 01	464 g	10	pc(s)	133/236
478 200	035652	01 05 01 01	263 g	10	pc(s)	130/234
478 410	136335	01 05 01 01	580 g	1	pc(s)	130/237
478 430	136342	01 05 01 01	680 g	1	pc(s)	130/237
478 450	136359	01 05 01 01	780 g	1	pc(s)	130/237
478 530	120341	01 05 01 01	697 g	1	pc(s)	131/237
478 540	120358	01 05 01 01	750 g	1	pc(s)	131/237
478 550	120365	01 05 01 01	838 g	1	pc(s)	131/237
478 598	158016	01 06 01 01	120 g	10	pc(s)	131/237
478 599	158023	01 06 01 01	170 g	10	pc(s)	131/237
478 699	158054	01 05 01 01	122 g	10	pc(s)	133/236
480 003	035348	01 06 01 01	24 g	50	pc(s)	71
480 004	035355	01 06 01 01	26 g	50	pc(s)	71
480 018	076372	01 02 01 01	1.90 kg	10	pc(s)	57/230
480 019	068339	01 02 01 01	1.82 kg	10	pc(s)	57/230
480 020	051638	01 02 01 01	2.24 kg	10	pc(s)	57/230
480 021	051621	01 02 01 01	3.06 kg	10	pc(s)	57/230
480 113	112681	01 06 01 01	61 g	50	pc(s)	71
480 150	019591	01 02 01 01	2.58 kg	1	pc(s)	57/229
480 157	019577	01 02 01 01	2.87 kg	1	pc(s)	57/229
480 291	149441	01 06 01 01	9 g	100	pc(s)	70/71
480 598	105607	01 07 01 01	80 g	1	pc(s)	186
480 599	105614	01 07 01 01	9 g	1	pc(s)	186
480 698	144590	01 07 01 01	128 g	1	pc(s)	219
480 699	107229	01 07 01 01	12 g	1	pc(s)	219
481 0xx	025608	01 06 01 01	27 g	1	pc(s)	71
482 0xx	025615	01 06 01 01	28 g	1	pc(s)	71
483 100	019430	01 01 01 01	1.60 kg	10	pc(s)	95
483 125	019416	01 01 01 01	2 kg	10	pc(s)	95
483 150	019492	01 02 01 01	2.40 kg	10	pc(s)	57/230
483 200	019713	01 02 01 01	3.20 kg	10	pc(s)	57/230
490 000	306417	01 06 01 01	1 g	100	pc(s)	70
490 001	306431	01 06 01 01	1 g	100	pc(s)	70

Part No.	GTIN*	PG	Weight	PU	SU	Page
490 002	306493	01 06 01 01	1 g	100	pc(s)	70
490 003	306509	01 06 01 01	1 g	100	pc(s)	70
490 004	306516	01 06 01 01	1 g	100	pc(s)	70
490 005	306523	01 06 01 01	1 g	100	pc(s)	70
490 006	306530	01 06 01 01	1 g	100	pc(s)	70
490 007	306547	01 06 01 01	1 g	100	pc(s)	70
490 008	306554	01 06 01 01	1 g	100	pc(s)	70
490 009	306561	01 06 01 01	1 g	100	pc(s)	70
490 020	306578	01 06 01 01	4 g	100	pc(s)	70
490 021	306585	01 06 01 01	34 g	50	pc(s)	70
490 022	306592	01 06 01 01	10 g	100	pc(s)	70
490 099	306455	01 06 01 01	7.93 kg	1	pc(s)	70
490 100	306486	01 06 01 01	6 g	100	pc(s)	69
490 110	306462	01 06 01 01	23 g	50	pc(s)	69
490 116	306479	01 06 01 01	24 g	50	pc(s)	69
490 900	306424	01 06 01 01	1 g	100	pc(s)	70
490 999	306448	01 06 01 01	7.93 kg	1	pc(s)	69
505 901	019355	01 50 50 01	2 g	20	pc(s)	285
524 906	004009	01 50 50 01	1 g	20	pc(s)	285
528 610	150553	01 06 01 01	3 g	500	pc(s)	30
528 619	108882	01 06 01 01	7 g	1	pc(s)	29
528 820	400122	01 06 01 01	99 g	1	pc(s)	105/162
528 821	400139	01 06 01 01	98 g	1	pc(s)	105/162
528 850	020955	01 06 01 01	15 g	1	pc(s)	55/65
528 870	020962	01 06 01 01	22 g	1	pc(s)	55/65
538 010	054868	01 03 01 02	8 g	500	pc(s)	53/65
538 030	026902	01 03 01 02	19 g	300	pc(s)	55/65
540 100	094109	01 05 01 02	133 g	10	pc(s)	262/272
540 103	101302	01 05 01 02	120 g	10	pc(s)	262/272
540 104	239685	01 05 01 05	127 g	10	pc(s)	280
540 105	115880	01 05 01 02	359 g	1	pc(s)	112
540 110	094116	01 05 01 02	98 g	50	pc(s)	262/272
540 120	379947	01 04 01 02	144 g	25	pc(s)	273
540 121	380660	01 04 01 02	144 g	25	pc(s)	248/272
540 122	379930	01 04 01 02	63 g	25	pc(s)	51/272
540 199	304741	01 05 01 05	107 g	25	pc(s)	280
540 200	113039	01 05 01 02	136 g	10	pc(s)	273
540 210	221284	01 05 01 02	98 g	50	pc(s)	273
540 250	138650	01 04 01 02	60 g	50	pc(s)	275
540 251	138674	01 04 01 02	37 g	10	pc(s)	275
540 260	138667	01 04 01 02	60 g	50	pc(s)	275
540 261	138681	01 04 01 02	36 g	10	pc(s)	275
540 270	320536	01 04 01 02	100 g	50	pc(s)	220
540 271	385306	01 04 01 01	50 g	50	pc(s)	74/220
540 801	115460	01 05 01 05	503 g	1	pc(s)	279
540 803	115477	01 05 01 05	566 g	1	pc(s)	279
540 805	128873	01 05 01 05	766 g	1	pc(s)	279
540 810	115484	01 05 01 05	550 g	1	pc(s)	279
540 821	123724	01 05 01 05	249 g	1	pc(s)	279
540 900	076532	01 05 01 02	55 g	50	pc(s)	271
540 901	076525	01 05 01 02	6.28 kg	1	pc(s)	120/280
540 905	273269	01 05 01 02	3.45 kg	1	pc(s)	52
540 910	025684	01 05 01 02	71 g	10	pc(s)	271
540 911	025691	01 05 01 02	76 g	10	pc(s)	271
540 912	035362	01 05 01 02	94 g	10	pc(s)	271
540 920	144194	01 05 01 02	29 g	10	pc(s)	271
540 930	101319	01 05 01 02	24 g	25	pc(s)	52
540 931	101296	01 05 01 02	1.69 kg	1	pc(s)	52

Part No. / GTIN* / PG / Weight / PU / SU / Page

Part No.	GTIN*	PG	Weight	PU	SU	Page
545 000	027367	03 05 01 03	10.50 g/m	100	m	292
545 001	141131	03 05 01 03	10.50 g/m	100	m	292
546 000	019959	03 06 01 01	465 g	1	pc(s)	277
546 001	019973	03 06 01 01	470 g	1	pc(s)	277
546 002	004016	03 06 01 01	177 g	1	pc(s)	277
546 025	004023	03 06 01 01	178 g	1	pc(s)	277
549 000	025547	01 04 01 03	6.20 kg	1	pc(s)	66
549 001	025554	01 04 01 03	6.10 kg	1	pc(s)	66
549 050	128217	01 04 01 03	1.90 kg	1	pc(s)	66
549 051	128224	01 04 01 03	1.38 kg	1	pc(s)	66
549 090	128231	01 04 01 03	3.58 kg	1	pc(s)	67
549 091	128248	01 04 01 03	3.00 kg	1	pc(s)	67
552 010	021150	01 01 01 03	33 g	25	pc(s)	27
552 030	021563	01 01 01 03	196 g	25	pc(s)	27
554 011	030756	01 06 01 01	46 g/m	1	m	294
556 125	028517	01 06 01 01	560 g	24	pc(s)	221/294
556 130	028524	01 06 01 01	1.28 kg	12	pc(s)	221/294
562 001	019782	01 06 01 01	4 g	100	pc(s)	90
562 035	019744	01 06 01 01	3 g	100	pc(s)	90
562 050	019751	01 06 01 01	4 g	100	pc(s)	90
562 101	019799	01 06 01 01	3 g	100	pc(s)	90
562 135	019768	01 06 01 01	2 g	100	pc(s)	90
562 150	019775	01 06 01 01	4 g	100	pc(s)	90
562 250	019737	01 06 01 01	2 g	100	pc(s)	90
562 440	019805	01 06 01 01	38 g	1	pc(s)	90
562 460	019812	01 06 01 01	57 g	1	pc(s)	90
563 010	027800	01 05 01 03	469 g	1	pc(s)	266
563 011	027732	01 05 01 03	13 g	200	pc(s)	267
563 012	027749	01 05 01 03	63 g	1	pc(s)	267
563 013	027756	01 05 01 03	32 g	100	pc(s)	267
563 014	027787	01 05 01 03	11 g	50	pc(s)	267
563 015	027794	01 05 01 03	59 g	10	pc(s)	266
563 016	027763	01 05 01 03	166 g	10	pc(s)	267
563 017	027770	01 05 01 03	370 g	10	pc(s)	267
563 018	083585	01 05 01 03	672 g	1	pc(s)	267
563 019	096998	01 05 01 03	65 g	1	pc(s)	267
563 020	027817	01 05 01 03	476 g	1	pc(s)	266
563 030	027824	01 05 01 03	444 g	1	pc(s)	266
563 040	082861	01 05 01 03	460 g	1	pc(s)	266
563 050	054707	01 05 01 03	226 g	1	pc(s)	265
563 105	027831	01 05 01 03	210 g	10	pc(s)	265
563 169	104839	01 05 01 04	76 g	50	pc(s)	278
563 200	056558	01 05 01 03	410 g	1	pc(s)	265
563 201	101234	01 05 01 03	397 g	1	pc(s)	265
572 000	021723	01 06 01 02	198 g	1	pc(s)	294
573 000	021617	01 06 01 01	25 kg/pc(s)	25	kg	229/246
578 110	096974	03 05 01 01	1.20 kg	1	pc(s)	289
578 351	356429	03 05 01 01	850 g	1	pc(s)	289
578 352	370982	03 05 01 01	677 g	1	pc(s)	289
578 353	390263	03 05 01 01	616 g	1	pc(s)	289
578 370	110953	03 05 01 01	240 g	1	pc(s)	290
578 386	353329	03 05 01 01	2.23 kg	1	pc(s)	290

Part No.	GTIN*	PG	Weight	PU	SU	Page
582 600	034730	03 05 01 02	5.88 kg	1	pc(s)	291
582 620	110960	03 05 01 02	3.77 kg	1	pc(s)	291
585 010	029620	03 05 01 03	211 g	1	pc(s)	292
585 025	029637	03 05 01 03	468 g	1	pc(s)	292
585 051	141155	03 05 01 03	740 g	1	pc(s)	292
585 200	029712	03 05 01 03	211 g	1	pc(s)	292
585 210	029729	03 05 01 03	1.33 kg	1	pc(s)	292
585 211	141162	03 05 01 03	1.33 kg	1	pc(s)	292
585 310	034679	03 05 01 03	468 g	1	pc(s)	292
585 320	148024	03 05 01 03	740 g	1	pc(s)	292
587 460	035263	03 05 01 03	368 g	1	pc(s)	291
588 000	027404	03 05 01 03	100 g	1	pc(s)	291
589 000	027411	03 05 01 03	292 g	1	pc(s)	291
595 000	046535	01 06 01 02	329 g	1	pc(s)	293
596 000	046528	01 06 01 02	362 g	1	pc(s)	293
597 003	027725	01 06 01 02	30.44 kg	1	pc(s)	293
597 004	027701	01 06 01 02	5.95 kg	1	pc(s)	293
597 005	027718	01 06 01 02	15.70 kg	1	pc(s)	293
597 006	029606	01 06 01 02	42.80 kg	1	pc(s)	293
597 020	154957	01 06 01 02	155 g	1	pc(s)	219
597 032	155008	01 06 01 02	1.49 kg	1	pc(s)	151/212
597 101	143838	01 06 01 02	10 g/Sa	1	Sa	151/189
597 102	153127	01 06 01 02	3.30 g/Sa	1	Sa	212
597 120	142497	01 06 01 02	100 g	1	pc(s)	151/189
597 127	153110	01 06 01 02	412 g	1	pc(s)	212
597 130	155022	01 06 01 02	1 g	1	pc(s)	151/190
597 139	157941	01 06 01 02	172 g	1	pc(s)	151/212
597 220	144972	01 06 01 02	330 g	1	pc(s)	150/189
597 227	153103	01 06 01 02	699 g	1	pc(s)	212
597 230	155015	01 06 01 02	202 g	1	pc(s)	151/190
597 320	154940	01 06 01 02	442 g	1	pc(s)	219
599 100	287402	01 06 01 03	370 g	1	pc(s)	55/292
600 003	026957	03 04 01 03	39 kg	1	pc(s)	253
600 029	026803	03 04 01 03	5.30 kg	1	pc(s)	253
600 035	033436	03 04 01 03	4.55 kg	1	pc(s)	253
600 050	052260	03 04 01 03	2.22 kg	1	pc(s)	253
610 010	022010	03 04 01 01	786 g	1	pc(s)	248
610 020	054110	03 04 01 01	436 g	25	pc(s)	248
618 214	322950	03 03 01 01	2 kg	1	pc(s)	220
620 001	021938	03 04 01 02	36 g	100	pc(s)	245
620 002	066052	03 04 01 03	857 g	1	pc(s)	252
620 005	027039	03 04 01 03	1.07 kg	1	pc(s)	249
620 007	027084	03 04 01 03	1.08 kg	1	pc(s)	250
620 008	066151	03 04 01 03	1.44 kg	1	pc(s)	250
620 009	118119	03 04 01 03	2.80 kg	1	pc(s)	250
620 010	244764	03 04 01 03	2.31 kg	1	pc(s)	250
620 011	026636	03 04 01 01	315 g	20	pc(s)	247
620 012	026698	03 04 01 01	418 g	10	pc(s)	248
620 015	026582	03 04 01 01	370 g	20	pc(s)	247
620 017	026612	03 04 01 01	420 g	1	pc(s)	247
620 019	027008	03 04 01 03	1.98 kg	1	pc(s)	250

Part No. / GTIN* / PG / Weight / PU / SU / Page

Part No.	GTIN*	PG	Weight	PU	SU	Page
620 021	026667	03 04 01 01	289 g	1	pc(s)	248
620 029	066113	03 04 01 03	1.43 kg	1	pc(s)	251
620 030	244818	03 04 01 03	800 g	1	pc(s)	251
620 031	244849	03 04 01 03	1.14 kg	1	pc(s)	251
620 101	021860	03 03 01 01	2.50 kg	6	pc(s)	245
620 151	021846	03 03 01 01	3.70 kg	6	pc(s)	245
620 902	021914	03 03 01 02	3.67 kg	6	pc(s)	245
620 903	342859	03 03 01 02	2.43 kg	6	pc(s)	245
620 915	026629	03 04 01 01	298 g	20	pc(s)	247
625 001	021945	03 04 01 02	69 g	50	pc(s)	245
625 002	095380	03 04 01 03	810 g	1	pc(s)	252
625 005	027046	03 04 01 03	1.05 kg	1	pc(s)	249
625 007	027091	03 04 01 03	1.06 kg	1	pc(s)	250
625 008	066144	03 04 01 03	1.41 kg	1	pc(s)	250
625 009	118126	03 04 01 03	2.80 kg	1	pc(s)	250
625 010	157613	03 04 01 03	2.25 kg	1	pc(s)	250
625 011	026643	03 04 01 01	340 g	20	pc(s)	247
625 012	026704	03 04 01 01	424 g	1	pc(s)	248
625 015	026599	03 04 01 01	383 g	20	pc(s)	247
625 019	027015	03 04 01 03	1.94 kg	1	pc(s)	250
625 021	026674	03 04 01 01	310 g	20	pc(s)	248
625 029	066120	03 04 01 03	1.41 kg	1	pc(s)	251
625 030	244825	03 04 01 03	760 g	1	pc(s)	251
625 031	244856	03 04 01 03	1.10 kg	1	pc(s)	251
625 101	021877	03 03 01 01	3.72 kg	6	pc(s)	245
625 151	021853	03 03 01 01	5.72 kg	6	pc(s)	245
630 120	107427	03 04 01 01	152 g	25	pc(s)	247
630 129	107434	03 04 01 01	150 g	25	pc(s)	247
634 145	125735	03 07 01 01	1.20 kg	1	pc(s)	263
634 160	125728	03 07 01 01	1.60 kg	1	pc(s)	263
635 100	056640	03 02 01 01	2.53 kg	5	pc(s)	246
635 150	056657	03 02 01 01	3.75 kg	5	pc(s)	246
635 200	056664	03 02 01 01	5.28 kg	5	pc(s)	246
635 250	067011	03 02 01 01	6.20 kg	3	pc(s)	246
640 015	106864	03 04 01 01	389 g	1	pc(s)	247
640 150	105850	03 03 01 03	2.23 kg	6	pc(s)	246
644 000	030268	03 07 01 01	4.45 kg	1	pc(s)	263
646 000	078161	03 07 01 01	2.24 kg	1	pc(s)	246
648 005	129160	03 04 01 03	1.46 kg	1	pc(s)	251
648 007	129177	03 04 01 03	1.46 kg	1	pc(s)	251
648 009	315501	03 04 01 03	973 g	1	pc(s)	252
648 029	236059	03 04 01 03	1.60 kg	1	pc(s)	252
648 031	293182	03 04 01 03	1.51 kg	1	pc(s)	252
649 005	119437	03 04 01 03	1.41 kg	1	pc(s)	251
649 007	119444	03 04 01 03	1.19 kg	1	pc(s)	251
649 009	315495	03 04 01 03	1.14 kg	1	pc(s)	252
649 015	119376	03 04 01 01	300 g	20	pc(s)	247
649 029	120501	03 04 01 03	1.53 kg	1	pc(s)	252
649 031	279698	03 04 01 03	1.45 kg	1	pc(s)	252
649 150	126350	03 03 01 03	1.71 kg	6	pc(s)	246
800 008	018716	02 01 01 01	394 g/m	127	m	20/225
800 010	018723	02 01 01 01	617 g/m	81	m	20/225
800 108	018754	02 01 01 01	440 g/m	75	m	20/225

Part No.	GTIN*	PG	Weight	PU	SU	Page
800 110	018761	02 01 01 01	680 g/m	50	m	20/225
800 310	131064	02 01 01 01	617 g/m	30	m	20/225
800 910	253315	02 01 01 01	1.85 kg	10	pc(s)	20/225
800 911	273689	02 01 01 01	4.10 kg/pc(s)	1	pc(s)	20/225
801 050	018921	02 03 01 01	330 g/m	100	m	22/228
810 225	018815	02 02 01 01	400 g/m	100	m	21/227
810 304	019232	02 02 01 01	960 g/m	52	m	21/227
810 335	032880	02 02 01 01	840 g/m	50	m	21/227
810 404	048256	02 02 01 01	1.28 kg/m	40	m	21/227
810 405	032897	02 02 01 01	1.60 kg/m	30	m	21/227
819 124	329003	01 07 01 02	520 g/m	500	m	144/156
819 125	118416	01 07 01 02	520 g/m	100	m	144/156
819 129	223158	01 07 01 02	3.16 kg	1	pc(s)	144/159
819 131	223189	01 07 01 01	2.88 kg	1	pc(s)	160/131
819 132	223172	01 07 01 01	3.62 kg	1	pc(s)	172
819 135	141759	01 07 01 01	488 g/m	100	m	172
819 136	147140	01 07 01 01	630 g/m	100	m	172
819 137	152625	01 07 01 03	854 g/m	100	m	197
819 142	152458	01 07 01 03	410 g	1	pc(s)	198
819 145	152533	01 07 01 01	377 g	1	pc(s)	161/173
819 146	152540	01 07 01 01	389 g	1	pc(s)	173
819 147	152557	01 07 01 01	394 g	1	pc(s)	173
819 148	152564	01 07 01 01	419 g	1	pc(s)	173
819 149	272057	01 07 01 03	800 g	1	pc(s)	198
819 160	152298	01 07 01 03	4.80 kg	1	pc(s)	197
819 161	281646	01 07 01 03	25.97 kg	1	pc(s)	197
819 163	280199	01 07 01 03	4.36 kg	1	pc(s)	197
819 165	272224	01 07 01 03	4.48 kg	1	pc(s)	197
819 183	249325	01 07 01 01	737 g	1	pc(s)	176/199
819 184	249318	01 07 01 01	2 kg	1	pc(s)	176/199
819 185	249288	01 07 01 01	1.15 kg	1	pc(s)	176/199
819 186	249295	01 07 01 01	3.25 kg	1	pc(s)	176/199
819 196	222229	01 07 01 01	203 g	1	pc(s)	174
819 197	222236	01 07 01 01	195 g	1	pc(s)	173
819 198	222250	01 07 01 01	205 g	1	pc(s)	174
819 199	222274	01 07 01 01	198 g	1	pc(s)	173
819 220	244238	01 07 01 01	2.80 kg	1	pc(s)	172
819 223	157675	01 07 01 01	4.00 kg	1	pc(s)	172
819 226	260528	01 07 01 01	13.86 kg	1	pc(s)	172
819 227	157712	01 07 01 01	3.90 kg	1	pc(s)	172
819 243	255951	01 07 01 02	7.93 kg	1	pc(s)	159
819 247	260900	01 07 01 01	6.80 kg	1	pc(s)	160
819 255	255371	01 07 01 02	5.68 kg	1	pc(s)	156
819 256	255388	01 07 01 02	6.03 kg	1	pc(s)	156
819 257	255395	01 07 01 02	6.58 kg	1	pc(s)	156
819 258	255418	01 07 01 02	6.97 kg	1	pc(s)	156
819 259	256088	01 07 01 02	10.99 kg	1	pc(s)	156
819 271	255845	01 07 01 02	336 g	1	pc(s)	157
819 272	255876	01 07 01 02	366 g	1	pc(s)	157/160
819 282	252073	01 07 01 02	4.60 kg	1	pc(s)	145
819 287	252097	01 07 01 02	4.47 kg	1	pc(s)	145
819 288	236479	01 07 01 02	172 g	1	pc(s)	174
819 289	236486	01 07 01 02	500 g	1	pc(s)	145
819 294	152571	01 07 01 01	701 g	1	pc(s)	174
819 299	118911	01 07 01 02	139 g	1	pc(s)	144
819 326	260511	01 07 01 01	8.40 kg	1	pc(s)	170
819 328	260504	01 07 01 01	8.80 kg	1	pc(s)	170
819 336	241237	01 07 01 01	9.60 kg	1	pc(s)	170
819 338	241244	01 07 01 01	10 kg	1	pc(s)	170
819 371	260498	01 07 01 01	17 kg	1	pc(s)	170

Part No. / GTIN* / PG / Weight / PU / SU / Page

Part No.	GTIN*	PG	Weight	PU	SU	Page
819 373	260481	01 07 01 01	17.90 kg	1	pc(s)	171
819 380	241916	01 07 01 02	13.76 kg	1	pc(s)	146
819 381	241954	01 07 01 01	18.50 kg	1	pc(s)	170
819 383	241961	01 07 01 01	19.10 kg	1	pc(s)	171
819 385	241923	01 07 01 02	13.15 kg	1	pc(s)	146
819 390	241930	01 07 01 02	13.15 kg	1	pc(s)	146
819 426	260474	01 07 01 01	11.30 kg	1	pc(s)	170
819 430	152236	01 07 01 03	15.40 kg	1	pc(s)	196
819 431	155442	01 07 01 03	17 kg	1	pc(s)	196
819 433	155459	01 07 01 03	21 kg	1	pc(s)	196
819 438	241251	01 07 01 01	12.50 kg	1	pc(s)	170
819 473	260450	01 07 01 01	37 kg	1	pc(s)	171
819 483	241978	01 07 01 01	38.20 kg	1	pc(s)	171
819 730	243477	01 07 01 01	53 kg	1	pc(s)	171
819 760	240391	01 07 01 03	56.64 kg	1	pc(s)	196
830 008	018785	02 01 01 02	448 g/m	100	m	19/226
830 038	035690	02 01 01 02	448 g/m	100	m	19/226
830 108	080430	02 01 01 02	448 g/m	20	m	19/226
830 208	106116	01 07 01 01	2.60 kg	1	pc(s)	218
830 218	106123	01 07 01 01	3.60 kg	1	pc(s)	218
831 225	018891	02 02 01 02	450 g/m	100	m	21/227
832 095	048324	02 03 01 02	845 g/m	50	m	23/228
832 120	129610	02 03 01 02	1.06 kg/m	50	m	23/228
832 192	018914	02 03 01 02	597 g/m	50	m	23/228
832 193	093430	02 03 01 02	597 g/m	100	m	23/228
832 202	081048	02 03 01 02	597 g/m	50	m	23/229
832 292	093171	02 03 01 02	597 g/m	100	m	23/285
832 295	093447	02 03 01 02	845 g/m	50	m	23/229
832 320	129641	02 03 01 02	1.06 kg/m	50	m	23/229
832 739	018907	02 03 01 02	438 g/m	50	m	23/228
832 740	093454	02 03 01 02	438 g/m	100	m	23/228
832 838	335776	02 03 01 02	334 g/m	100	m	23/285
832 839	093164	02 03 01 02	438 g/m	100	m	23/285
833 008	151987	02 01 01 02	182 g/m	110	m	19/226
840 008	018730	02 01 01 04	135 g/m	148	m	19/226
840 010	018747	02 01 01 04	210 g/m	100	m	19/226
840 018	035706	02 01 01 04	135 g/m	148	m	19/226
840 028	131163	02 01 01 04	135 g/m	21	m	19/226
840 050	070141	02 03 01 04	133 g/m	100	m	22/228
840 108	080423	02 01 01 04	135 g/m	21	m	19/226
840 118	071483	02 01 01 04	200 g/m	100	m	19/226
840 128	160002	02 01 01 04	200 g/m	100	m	19/226
850 008	129627	02 03 01 03	235 g/m	100	m	22/228
850 010	129634	02 03 01 03	395 g/m	100	m	22/228
852 335	031067	02 02 01 01	840 g/m	25	m	21/227
860 008	018808	02 01 01 03	395 g/m	125	m	20/225
860 010	019997	02 01 01 03	617 g/m	80	m	20/225
860 020	092662	02 01 01 03	617 g/m	20	m	20/225
860 050	139923	02 01 01 03	617 g/m	50	m	20/225

Part No.	GTIN*	PG	Weight	PU	SU	Page
860 110	150256	02 01 01 03	624 g	5	pc(s)	58/231
860 115	101104	02 01 01 03	930 g	5	pc(s)	58/231
860 130	101111	02 01 01 03	1.80 kg	5	pc(s)	58/231
860 210	159365	02 02 01 03	830 g	5	pc(s)	58/231
860 215	101081	02 02 01 03	1.25 kg	5	pc(s)	58/231
860 230	101098	02 02 01 03	2.48 kg	5	pc(s)	58/231
860 315	150058	02 02 01 03	1.25 kg	5	pc(s)	58/231
860 325	093157	02 02 01 03	825 g/m	25	m	22/227
860 330	150065	02 02 01 03	2.50 kg	5	pc(s)	58/231
860 335	143388	02 02 01 03	827 g/m	60	m	22/227
860 404	276482	02 02 01 03	1.26 kg/m	40	m	22/227
860 405	276499	02 02 01 03	1.57 kg/m	30	m	22/227
860 425	227774	02 02 01 03	2.40 kg	5	pc(s)	58/231
860 430	227781	02 02 01 03	2 kg	5	pc(s)	58/231
860 900	143395	02 02 01 03	824 g/m	60	m	22/227
860 908	019362	02 01 01 03	395 g/m	125	m	20/225
860 910	019300	02 01 01 03	617 g/m	80	m	20/225
860 920	092679	02 01 01 03	617 g/m	20	m	20/225
860 925	093140	02 02 01 03	825 g/m	25	m	22/227
860 950	155596	02 01 01 03	617 g/m	50	m	20/225
920 000	057494	04 01 05 01	127 g	1	pc(s)	275
923 019	033177	04 01 05 02	1.70 kg	1	pc(s)	286
923 021	036161	04 01 05 01	185 g	1	pc(s)	276
923 023	074262	04 01 05 01	185 g	1	pc(s)	276
923 025	110397	04 01 05 03	137 g	1	pc(s)	287
923 035	110403	04 01 05 03	163 g	1	pc(s)	287
923 045	110410	04 01 05 03	190 g	1	Stk.	287
923 060	038899	04 01 05 02	725 g	1	pc(s)	286
923 061	038905	04 01 05 02	750 g	1	pc(s)	286
923 062	038912	04 01 05 02	733 g	1	pc(s)	286
923 100	108325	04 01 05 02	289 g	1	pc(s)	286
923 101	108332	04 01 05 02	1.98 kg	1	pc(s)	287
923 211	150904	04 01 05 03	109 g	1	pc(s)	287
923 214	150911	04 01 05 03	107 g	1	pc(s)	287
923 218	150928	04 01 05 03	99 g	1	pc(s)	287
923 222	150935	04 01 05 03	95 g	1	pc(s)	287
923 226	150942	04 01 05 03	92 g	1	pc(s)	287
923 230	150959	04 01 05 03	180 g	1	pc(s)	287
923 233	150966	04 01 05 03	174 g	1	pc(s)	287
923 236	150973	04 01 05 03	167 g	1	pc(s)	287
923 239	150980	04 01 05 03	162 g	1	pc(s)	287
923 242	150997	04 01 05 03	158 g	1	pc(s)	287
923 311	150775	04 01 05 03	105 g	1	pc(s)	287
923 314	150782	04 01 05 03	103 g	1	pc(s)	287
923 318	150799	04 01 05 03	101 g	1	pc(s)	287
923 322	150805	04 01 05 03	96 g	1	pc(s)	287
923 326	150812	04 01 05 03	91 g	1	pc(s)	287
923 330	150829	04 01 05 03	178 g	1	pc(s)	287
923 333	150836	04 01 05 03	172 g	1	pc(s)	287
923 336	150843	04 01 05 03	168 g	1	pc(s)	287
923 339	150850	04 01 05 03	159 g	1	pc(s)	287
923 342	150867	04 01 05 03	158 g	1	pc(s)	287
923 348	150874	04 01 05 03	144 g	1	pc(s)	287
923 356	150881	04 01 05 03	262 g	1	pc(s)	287
923 362	150898	04 01 05 03	244 g	1	pc(s)	287

Type	Part No.	Page	Type	Part No.	Page	Type	Part No.	Page
AB EXFS IF1 W 11	923 311	287	AK 6.10 KB S KBF3 18 V2A	372 119	83	AW DEHNHELIX	597 230	165
AB EXFS IF1 W 14	923 314	287	AK 6.10 KB W KBF18 35 STTZN	372 240	83	BA 20X2.5 CU R100M	831 225	21
AB EXFS IF1 W 18	923 318	287	AK 6.10 KB W KBF18 35 V2A	372 249	83	BA 20X2.5 STTZN R100M	810 225	21
AB EXFS IF1 W 22	923 322	287	AK 6.10 KB W KBF3 18 STTZN	372 210	83	BA 30X3.5 STTZN R25M	852 335	21
AB EXFS IF1 W 26	923 326	287	AK 6.10 KB W KBF3 18 V2A	372 219	83	BA 30X3.5 STTZN R50M	810 335	21
AB EXFS IF1 W 30	923 330	287	AK 6.10 KSV S KBF18 35 V2A	372 159	83	BA 30X3.5 V2A R25M	860 925	22
AB EXFS IF1 W 33	923 333	287	AK 6.10 KSV S KBF3 18 V2A	372 129	83	BA 30X3.5 V2A R60M	860 900	22
AB EXFS IF1 W 36	923 336	287	AK 6.10 KSV W KBF18 35 V2A	372 259	83	BA 30X3.5 V4A R25M	860 325	22
AB EXFS IF1 W 39	923 339	287	AK 6.10 KSV W KBF3 18 V2A	372 229	83	BA 30X3.5 V4A R60M	860 335	22
AB EXFS IF1 W 42	923 342	287	AK 7.10 FL40 GBM10X45 STTZN	478 141	133	BA 30X4 STTZN R52M	810 304	21
AB EXFS IF1 W 48	923 348	287	AK 7.10 FL40 GBM12X55 V4A	478 149	133	BA 40X4 STTZN R40M	810 404	21
AB EXFS IF1 W 56	923 356	287	AK 7.10 FL40 GBM16X65 V4A	478 150	133	BA 40X4 V4A R40M	860 404	22
AB EXFS IF1 W 62	923 362	287	AK 7.10 FRM10X45 KBF0.4 12 RG	371 007	82	BA 40X5 STTZN R30M	810 405	21
AB EXFS IF3 G 11	923 211	287	AK 7.10 FRM10X45 KBF0.4 12 TGTZN	371 009	82	BA 40X5 V4A R30M	860 405	22
AB EXFS IF3 G 14	923 214	287	AK 7.10 KSV KBF1 12 TGTZN	370 014	82	BA RD8 BB16 V2A ZG	106 340	120
AB EXFS IF3 G 18	923 218	287	AK 7.10 KSV KBF8 18 TGTZN	370 018	82	BA130 RD8 BB16 V2A ZG	106 342	120
AB EXFS IF3 G 22	923 222	287	AK 7.10 KSV S KBF18 35 STTZN	372 150	83	BA90 RD8 BB16 V2A ZG	106 341	120
AB EXFS IF3 G 26	923 226	287	AK 7.10 KSV S KBF3 18 STTZN	372 120	83	BB 1XB11GSM8 1XB23GSM12 AL	105 229	145
AB EXFS IF3 G 30	923 230	287	AK 7.10 KSV W KBF18 35 STTZN	372 250	83	BB SPB30 BB16 V2A AL	106 321	119
AB EXFS IF3 G 33	923 233	287	AK 7.10 KSV W KBF3 18 STTZN	372 220	83	BB16 GSM10 AL	106 301	117
AB EXFS IF3 G 36	923 236	287	AK 8.10 AQ4 50 TE20 25 V4A	540 121	248	BB16 GSM10 V2A	106 309	117
AB EXFS IF3 G 39	923 239	287	AK ES TE 20 RD10 FL30 STTZN	630 120	247	BB16 IGM8 ZG	106 126	116
AB EXFS IF3 G 42	923 242	287	AK ES TE 20 RD10 FL30 V4A	630 129	247	BES 17KG KT16 D337	102 012	103
ABST 3F D50 2900 V2A	105 601	127	AK RPA V2A	563 169	278	BES 17KG KT16 D337 SET	102 010	102
AD PAS 10AP V2A	472 289	269	AK TE 20 7.10 FL40 V4A	610 020	248	BES 17KG KT16 ULP D337 SET	102 340	102
AD PAS 12AP V2A	472 299	269	AK TE 20.30 8.12 FL40 STTZN	610 010	248	BES 17KG M16 D337	102 002	103
AD PAS 6AP V2A	472 279	269	AK ZS 8.10 FL30 GBM10X60 V4A	478 129	133	BES 4.6KG SB10 180X180X70	253 301	122
AD PAS 8AP V2A	472 269	269	AKO TBM FP400	103 040	108	BES 8.5KG KT10 16 D240 SET	102 075	103
AD WAS 16 BB16 V2A	106 325	120	AKO TBM FP565	103 041	108	BES 8.5KG M16 D240	102 003	103
AD WAS 50 BB16 V2A	106 326	120	AL EXFS L100 KS	923 025	287	BFRS D80 B35 4FSP 10 1030 AL	819 185	176
AE BO10 HVI 20 SW V2A	819 199	173	AL EXFS L200 KS	923 035	287	BFRS D80 B35 4FSP 10 1030 V2A	819 186	176
AE BO10 HVI 23 GR V2A	819 198	174	AL EXFS L300 KS	923 045	287	BFRS D80 B35 4FSP 10 530 AL	819 183	176
AEA KO HVI 20 SW V2A	819 197	173	AL ZF B11.11 B5.2 6.5 L81 AL	377 005	87	BFRS D80 B35 4FSP 10 530 V2A	819 184	176
AEA KO HVI 23 GR V2A	819 196	174	AL ZF B11.11 B5.2 6.5 L81 CU	377 017	87	BFS D61 4X20	819 294	174
AEH 50 L22 CUGALSN	444 050	145	AL ZF B11.11 B5.2 6.5 L81 V2A	377 009	87	BFS M10X20 PAS STTZN	472 201	269
AF 10 V4A 1000	860 110	58	AL ZF DUL 6.10 B5.2 6.5 L81 AL	377 200	87	BFS M10X20 PAS V2A	472 202	269
AF 10 V4A 1500	860 115	58	AL ZF KB 6.10STTZN B5.2 6.5 L81 AL	377 100	87	BFS SR D50 4AE HVI LI AL V2A	819 289	145
AF 10 V4A 3000	860 130	58	AP 2X6.10 V2A	301 229	52	BN 5X10 AL V2A	528 610	30
AF 30X3.5 V2A B6.5X12 3000	860 425	58	AP L405 TGTZN	466 203	263	BP BB16 V2A ZG	106 127	117
AF 30X3.5 V4A 1000	860 210	58	AP SR D50 4AE HVI V2A	819 288	174	BP D100 GBM8 4XB10 4XB4 STTZN	297 015	26
AF 30X3.5 V4A 1500	860 215	58	AS 37 5 B7.5 UVS K BR	276 007	48	BP D40 GBM8 4XB4 K GR	297 025	26
AF 30X3.5 V4A 3000	860 230	58	AS 37 5 B7.5 UVS K GR	276 006	48	BRS 10.27 AQ2.5 10 V2A	540 920	271
AF 30X3.5 V4A B6.5X12 3000	860 430	58	AS 37 5 B8.5 V2A	276 009	48	BRS 16.168 AK1X10 2X6.8 V2A	540 100	262
AF 30X3.5 V4A ZW 1500	860 315	58	AS S RE 27 7.10 FL40 STTZN	640 015	247	BRS 16.89 AK1X10 2X6.8 V2A	540 103	262
AF 30X3.5 V4A ZW 3000	860 330	58	AS S TE 20 7.10 FL40 CU	620 017	247	BRS 27.114 AQ4 25 V2A	540 911	271
AH D50 1000 D100.150 STTZN	105 364	181	AS S TE 20 7.10 FL40 STTZN	620 015	247	BRS 27.168 AQ4 25 V2A	540 912	271
AH D50 1000 D150.190 STTZN	105 365	181	AS S TE 20 7.10 FL40 V4A	620 915	247	BRS 27.168 Z AK1X10 2X6.8 V2A	540 200	273
AH D50 1000 D55.100 STTZN	105 363	181	AS S TE 25 7.10 FL40 STTZN	625 015	247	BRS 27.60 AQ4 25 V2A	540 910	271
AH FE RF	290 002	244	AS S TE 25 7.10 FL40 V4A	649 015	247	BRS 27.89 AK1X10 2X6.8 GSG V2A	540 104	280
AH FE RF V G	290 001	244	AS SPB25 BB16 V2A	106 322	119	BRS 50.300 BB16 8 V2A	540 105	112
AH PAS RK	563 015	266	AS TE 20 2XKSV 7.10 STTZN	620 012	248	BRS SPB25 50.300 V2A	106 323	119
AH TSK WDV5 50.200 K	476 053	68	AS TE 20 ASSM10 STTZN	620 021	248	BS 4K 20.50 BB16 ZG V2A	106 312	119
AK 3.18 BB16 V2A AL	106 319	120	AS TE 20 KSV 7.10 STTZN	620 011	247	BS D40.50 4K20.50 V2A	105 356	126
AK 4.10 FRM10X45 KBF0.4 12 TGTZN	371 008	82	AS TE 25 2XKSV 7.10 STTZN	625 012	248	BS D40.50 4K60.120 V2A	105 376	126
AK 6.10 DS KBF18 35 STTZN	372 035	83	AS TE 25 ASSM10 STTZN	625 021	248	BS D40.50 D48.60 V2A	105 354	106
AK 6.10 DS KBF5 18 STTZN	372 018	83	AS TE 25 KSV 7.10 STTZN	625 011	247	BS D40.50 D70.90 V2A	105 355	126
AK 6.10 DS KBF5 18 V2A	372 019	83	ASK 8 150 40 2XB10.5 V2A	241 009	39	BS D40.50 DS95 SB50.300 V2A	105 163	106
AK 6.10 KB S KBF18 35 STTZN	372 140	83	ASSA D6 L1000 6.10 CU V2A	365 509	30	BS D50 DS30 SB50.300 V2A	105 361	125
AK 6.10 KB S KBF18 35 V2A	372 149	83	ASSA D8 L1000 6.10 CU V2A	365 519	30	BS D50 DS90 SB50.300 V2A	105 362	126
AK 6.10 KB S KBF3 18 STTZN	372 110	83	AW DEHNHELIX	597 230	151			

Type	Part No.	Page	Type	Part No.	Page	Type	Part No.	Page
BS D50 SB50.300 V2A	105 360	125	DH K 80 BS ML0.75 L100M BL	585 210	292	DLH DG 8 SF0.7 8 V2A	223 031	41
BSC 6.3X19 SW10 V2A	528 619	29	DH K 80 BS ML0.75 L100M RT	585 211	292	DLH DG 8 TD B8.5 V2A	223 021	42
BSC D40 D45.65 V2A	105 161	157	DH ZS 20 D16 1000 GFK PA	106 812	148	DLH DG H20 UK8 V2A	206 389	37
BSC D40 DS95 D45.65 V2A	105 162	106	DH ZS 20 D16 1270 GFK PA	106 815	183	DLH DQ 6.10 FG120.240 CU	202 027	32
BSC D40.50 SB50.300 V2A	105 160	106	DH ZS 20 D16 500 GFK PA	106 852	148	DLH DQ 6.10 FG120.240 STTZN	202 020	32
BUE SPB25 V2A	106 320	119	DH ZS 27 D16 1500 GFK PA	106 814	206	DLH DQ 6.10 FG120.240 V2A	202 900	32
BVK 16.48 6.10 FL40 BSB STBL	308 045	135	DICS WB D50 10 5700 GFK AL V2A	105 455	123	DLH DQ 6.10 FG200.280 CU	202 227	32
BVK 16.48 FL40 KB6.10 BSB STBL	308 046	131	DICS WB D50 10 7200 GFK AL V2A	105 470	123	DLH DQ 6.10 FG200.280 STTZN	202 021	32
BW45 B11 B5.1 6.5 11 V2A	106 315	118	DICS WB D50.10 4.2M GFK AL V2A	105 440	123	DLH DQ 6.10 GP100X100 STTZN	202 060	26
BW90 B11 B5.1 6.5 11 V2A	106 310	118	DIDH 16 1015 V2A GFK16	106 185	117	DLH DQ 6.10 GP50X60 STTZN	202 030	26
BW90 BB16 B5.1 6.5 11 V2A	106 311	118	DIDH 16 1030 BP V2A GFK	106 123	115	DLH DQ 6.10 H55 L115 WS STTZN	202 050	36
CUI HEAD 20	597 020	219	DIDH 16 1030 RS40.60 V2A	106 228	115	DLH DQ 6.10 H55 L260 CU	202 037	36
CUI L 20 GR 3.5M	830 208	218	DIDH 16 1030 SB50.300 V2A	106 248	116	DLH DQ 6.10 H55 L260 GS CU	202 017	36
CUI L 20 GR 5M	830 218	218	DIDH 16 515 V2A GFK16	106 178	117	DLH DQ 6.10 H55 L260 GS STTZN	202 010	36
CUI STRIP 20	597 320	219	DIDH 16 530 BP V2A GFK	106 115	115	DLH DQ 6.10 H55 L260 GS V2A	202 901	36
CUPAB 500X40X0.5 AL CU	562 440	90	DIDH 16 530 RS40.60 V2A	106 225	115	DLH DQ 6.10 H55 L260 STTZN	202 040	36
CUPAB 500X60X0.5 AL CU	562 460	90	DIDH 16 530 SB50.300 V2A	106 245	116	DLH DQ 6.10 H55 L260 V2A	202 902	36
CUPAH GL Q25 L29 AL CU	562 250	90	DIDH 16 675 V2A GFK16	106 180	117	DLH DQ 6.10 H55 L410 WS STTZN	202 080	36
CUPAH GL Q35 L32 AL CU	562 035	90	DIDH 16 690 BP V2A GFK	106 120	115	DLH DQ 6.10 WPRO5 8 STTZN	202 015	43
CUPAH GL Q35 L32 CU AL	562 135	90	DIDH 16 690 RS40.60 V2A	106 226	115	DLH DQ 6.10 WPRO5 8 V2A	202 906	43
CUPAH GL Q50 L40 AL CU	562 050	90	DIDH 16 690 SB50.300 V2A	106 246	116	DLH DQ 6.10 WPRO5 STTZN	202 005	43
CUPAH GL Q50 L40 CU AL	562 150	90	DIDH 6.10 675 MMV KT V2A GFK	106 150	116	DLH DQ 8 WPRO5 V2A STTZN	206 105	43
CUPAH UGL Q50 L60 AL CU	562 001	90	DIDH 7.10 1015 V2A GFK16	106 175	117	DLH DS 8 H16 FG180.280 BR V2A	204 911	32
CUPAH UGL Q50 L60 CU AL	562 101	90	DIDH 7.10 1030 BP V2A GFK	106 105	115	DLH DS 8 H16 FG180.280 GR V2A	204 109	32
DADS D10 16 48 AL ROT	105 246	161	DIDH 7.10 1030 D50 V2A	106 331	127	DLH DS 8 H16 FG180.280BR GALCU	204 107	32
DADS D10 16 48 AL SCH	105 245	161	DIDH 7.10 515 V2A GFK16	106 165	117	DLH DS 8 H16 L169 WS V2A	204 359	36
DASH D48 A5600.750 STTZN	105 240	161	DIDH 7.10 530 BP V2A GFK	106 090	115	DLH DS 8 H16 WPRO5 8 BR V2A	204 916	43
DB 700X30X4 V2A	308 150	244	DIDH 7.10 675 V2A GFK16	106 170	117	DLH DS 8 H16 WPRO5 8 GR V2A	204 906	43
DBS KB D40.50 RA1100 V2A	105 291	102	DIDH 7.10 690 BP V2A GFK	106 100	115	DLH DS 8 H36 FG180.280 BR V2A	204 913	32
DBS KB D40.50 RA1435 STTZN	105 201	127	DIDH 7.10 690 D50 V2A	106 328	127	DLH DS 8 H36 FG180.280 GR V2A	204 129	32
DBS KB D40.50 RA560 STTZN	105 200	102	DIDH 8 675 KT V2A GFK	106 160	116	DLH DS 8 H36 FG180.280BR GALCU	204 127	32
DBS KB D40.50 RA590 V2A	105 290	102	DIDH PAE 17 D16 750 AL V2A	105 460	148	DLH DS 8 H36 KP67 K GR	297 110	42
DBS KB D50 HS RA1450 V2A	105 391	178	DIDH PAE 20 D16 1270 AL V2A	105 461	183	DLH DS 8 H36 L205 BR AL	204 171	34
DBS KB D50 HS RA600 V2A	105 390	178	DIDH PAE 27 D16 1270 AL V2A	105 462	206	DLH DS 8 H36 L205 GR AL	204 170	34
DBS KB D50 RA620 STTZN	105 351	177	DIDLH 8 H295 D300 BS	253 115	122	DLH DS 8 H36 L90 EH BR V2A	204 239	38
DC BK 10 FL30 STBLANK	308 142	134	DIDLH 8 H435 D300 BS	253 125	122	DLH DS 8 H36 L90 EH GR V2A	204 229	38
DC BK 10 RD10 STBLANK	308 132	134	DILH 8 DS10 L280 K GR GFK	253 315	111	DLH FB 8 LO 100X100X70	253 015	25
DC BK 12 FL30 STBLANK	308 143	134	DILH 8 DS10 L420 K GR GFK	253 325	111	DLH FB2 8 FE 141X86X70	253 060	25
DC BK 12 RD10 STBLANK	308 133	134	DILH 8 SB10 K GR	253 302	122	DLH FB2 8 LO 141X86X70	253 050	25
DC BK 12 RD12 STBLANK	308 136	134	DIST 10 3000 GFK	253 310	122	DLH FG 8 H32 L170 V2A	204 949	33
DC BK 6 FL30 STBLANK	308 140	134	DIST 16 3000 GFK	106 125	116	DLH FG 8 H32 L170 V2A GALCU	204 957	33
DC BK 6 RD10 STBLANK	308 130	134	DIST 16 M10 1015 GFK	106 220	121	DLH FS 8 H16 L170 BR V2A	204 936	33
DC BK 6 RD6 STBLANK	308 134	134	DIST 16 M10 675 GFK	106 217	121	DLH FS 8 H16 L170 GR V2A	204 935	33
DC BK 8 FL30 STBLANK	308 141	134	DLH AL ZS 20 23 V2A	202 853	149	DLH FS 8 H36 L170 BR V2A	204 938	33
DC BK 8 RD10 STBLANK	308 131	134	DLH AL ZS 27 V2A	202 863	209	DLH FS 8 H36 L170 GR V2A	204 937	33
DC BK 8 RD12 STBLANK	308 137	134	DLH DG 8 H20 FG180.280 KK GALCU	206 807	32	DLH KB 6.10 KF18.22 AL	223 070	41
DC BK 8 RD8 STBLANK	308 135	134	DLH DG 8 H20 FG180.280 KK V2A	206 809	32	DLH KB 6.10 RSF20.25 AL	223 040	41
DDF 8 10 16 FL20.30 D250 K	552 030	27	DLH DG 8 H20 FG180.280 V2A	206 109	32	DLH KB 6.10 RSF20.25 V2A	223 010	41
DDF 8.10 D34 B16 K	552 010	27	DLH DG 8 H20 KB8.18 V2A	206 399	37	DLH KB 6.10 TD B8.5 V2A	223 020	42
DEHNIT 25KG	573 000	229	DLH DG 8 H20 L103 EH V2A	206 349	38	DLH KF 8 LO DBS 110X100X70 SW	253 030	25
DGP EP4	578 370	290	DLH DG 8 H20 L169 WS V2A	206 359	36	DLH KF ZS 20 23 V2A	202 851	149
DGPKO ML PK ... KL	582 620	291	DLH DG 8 H20 L205 V2A AL	206 170	35	DLH KF ZS 27 V2A	202 861	208
DH K 40 BB ASG L	585 010	292	DLH DG 8 H20 L87 EH V2A	206 369	38	DLH KF2 8 LO 141X86X70	253 051	25
DH K 40 BS ML0.75 L25M BL	585 025	292	DLH DG 8 H20 WPRO5 8 V2A	206 339	43	DLH RSF ZS 20 23 V2A	202 850	149
DH K 40 BS ML0.75 L25M RT	585 310	292	DLH DG 8 H32 FG180.280 KK GALCU	206 817	32	DLH RSF ZS 27 V2A	202 860	208
DH K 40 BS ML0.75 L50M BL	585 320	292	DLH DG 8 H32 FG180.280 KK V2A	206 819	32	DLH SF ZS 20 23 V2A	202 852	149
DH K 40 BS ML0.75 L50M RT	585 051	292	DLH DG 8 H32 KP67 V2A K GR	297 120	42	DLH SF ZS 27 V2A	202 862	209
DH K 80 BB ASG L	585 200	292	DLH DG 8 H32 L205 V2A AL	206 171	35	DLH SG 8 H20 FG180.280 CU	206 237	31
			DLH DG 8 R5F20.25 AL	223 041	41	DLH SG 8 H20 FG180.280 V2A	206 239	31
			DLH DG 8 R5F20.25 V2A	223 011	41	DLH SG 8 H32 FG180.280 CU	206 247	31

Type	Part No.	Page	Type	Part No.	Page	Type	Part No.	Page
EL16 L1.55M 1KSO 8.10 1SKS 16	416 016	260	ERS 34 AB11 V2A	410 339	274	FBH ZS 30 B6.5X16 H55X50 STTZN	286 030	53
EL16 L1.55M 2KSG 10	416 915	260	ERS 34 AS4.10 TG STTZN	407 100	273	FBH ZS 30 B6.5X16 H55X50 V2A	286 139	53
EL16 L1.55M 2KSO 8.10	416 015	256	ERS 42 AB11 STTZN	410 114	274	FBH ZS 30 B6.5X16 STTZN	284 030	53
EL16 L1.55M 2KSO 8.10 GG	417 015	257	ERS 42 AB11 V2A	410 349	274	FBH ZS 30 IGM8 KD8X40STTZN ZG	275 230	54
EL16 L1.55M KSO 8.10 KSG 8	416 415	259	ERS 42 AS4.10 TG STTZN	407 114	273	FBH ZS 30 IGM8 STTZN ZG	275 030	54
EL16 L10.05M 2KSO 8.10	416 100	256	ERS 48 AB11 STTZN	410 112	274	FBH ZS 30 KS KD8X40 V2A	274 230	53
EL16 L10.05M 2KSO 8.10 GG	417 100	257	ERS 48 AB11 V2A	410 359	274	FBH ZS 30 M8 V2A	274 030	53
EL16 L12.05M 2KSO 8.10	416 120	256	ERS 48 AS4.10 TG STTZN	407 112	273	FBH ZS 40 B6.5X16 STTZN	284 040	53
EL16 L14.05M 2KSO 8.10	416 140	256	ERS 55 AB11 STTZN	410 134	274	FK DUL 6.10 KBF0.7 8 V2A	365 019	84
EL16 L15.05M 2KSO 8.10	416 150	256	ERS 55 AB11 V2A	410 369	274	FK DUL 8.10 KBF0.7 8 CU	365 017	84
EL16 L15.05M 2KSO 8.10 GG	417 115	257	ERS 60 AB11 STTZN	410 200	274	FK DUL 8.10 KBF0.7 8 STTZN	365 010	84
EL16 L2.05M 1KSO 8.10 1KSG 10	416 421	259	ERS 60 AB11 V2A	410 379	274	FK KB 6.10 KBF0.7 10 CU	365 027	84
EL16 L2.05M 1KSO 8.10 1KSG 8	416 420	259	ERS 60 AS4.10 TG STTZN	407 200	273	FK KB 6.10 KBF0.7 10 STTZN	365 020	84
EL16 L2.05M 2KSG 10	416 920	260	ERS 76 AB11 STTZN	410 212	274	FK KB 6.10 KBF0.7 8 AL	365 031	84
EL16 L2.05M 2KSO 8.10	416 020	256	ERS 76 AB11 V2A	410 389	274	FK KB 6.10 KBF0.7 8 CU	365 037	84
EL16 L2.05M 2KSO 8.10 GG	417 020	257	ERS 89 AB11 STTZN	410 300	274	FK KB 6.10 KBF0.7 8 STTZN	365 030	84
EL16 L2.55M 1KSO 8.10 1KSG 10	416 426	259	ERS 89 AB11 V2A	410 399	274	FK KB 6.10 KBF0.7 8 V2A	365 039	84
EL16 L2.55M 1KSO 8.10 1KSG 8	416 425	259	ES 10AP 11X11 V2A	472 339	270	FK KB 6.10 KBF0.7 8 W AL	365 051	85
EL16 L2.55M 2KSG 10	416 925	260	ES 12AP 11X11 V2A	472 349	270	FK KB 6.10 KBF0.7 8 W CU	365 057	85
EL16 L2.55M 2KSO 8.10	416 025	256	ES 2X2 ASB11 STTZN	472 023	270	FK KB 6.10 KBF0.7 8 W STTZN	365 050	85
EL16 L20.05M 2KSO 8.10	416 200	256	ES 2X2 ASB11 V2A	472 109	270	FK KB 6.10 KBF0.7 8 W V2A	365 059	41
EL16 L20.05M 2KSO 8.10 GG	417 120	257	ES 2X3 ASB11 STTZN	472 022	270	FK MV 8.10 KBF0.7 10 AL	365 221	85
EL16 L22.05M 2KSO 8.10	416 220	256	ES 2X3 ASB11 V2A	472 119	270	FK MV 8.10 KBF0.7 10 CU	365 227	85
EL16 L25.05M 2KSO 8.10 GG	417 125	257	ES 2X4 ASB11 STTZN	472 024	271	FK MV 8.10 KBF0.7 10 STTZN	365 220	85
EL16 L28.05M 2KSO 8.10	416 280	256	ES 2X4 ASB11 V2A	472 129	271	FK MV 8.10 KBF0.7 10 V2A	365 229	85
EL16 L3.05M 1KSO 8.10 1KSG 10	416 431	259	ES 2X6 ASB11 STTZN	472 021	271	FK ZS 7.10 KBF0.7 10 CU	365 047	84
EL16 L3.05M 1KSO 8.10 1KSG 8	416 430	259	ES 2X6 ASB11 V2A	472 139	271	FK ZS 7.10 KBF0.7 10 STTZN	365 040	84
EL16 L3.05M 2KSG 10	416 930	260	ES 4AP 11X11 V2A	472 309	269	FK ZS 7.10 KBF0.7 6 RG	365 007	84
EL16 L3.05M 2KSO 8.10	416 030	256	ES 50X50X3 450 V2A	634 145	263	FK ZS 7.10 KBF0.7 6 ZG	365 000	84
EL16 L3.05M 2KSO 8.10 GG	417 030	257	ES 50X50X3 600 V2A	634 160	263	FK ZS 7.10 KF0.7 8 CU	251 027	84
EL16 L3.55M 2KSO 8.10	416 035	256	ES 6AP 11X11 V2A	472 319	269	FK ZS 7.10 KF0.7 8 STTZN	251 002	84
EL16 L30.05M 2KSO 8.10	416 300	256	ES 8AP 11X11 V2A	472 329	270	FLA30 FB KF K SW	253 021	26
EL16 L30.05M 2KSO 8.10 GG	417 130	257	ES ZF 2X11.11 1XB13 V2A	390 479	132	FM 60 L11M IP HVI M L10M GFK AL STTZN		
EL16 L4.05M 1KSO 8.10 1KSG 10	416 441	259	ES ZF 2XB11 KSV 7.10 STTZN	363 010	132		819 730	171
EL16 L4.05M 1KSO 8.10 1KSG 8	416 440	259	ES ZF 2XB18 V2A	390 499	132	FM 60 L11M IP HVIP L10M GFK AL STTZN		
EL16 L4.05M 2KSO 8.10	416 040	256	ES ZF 3XB11 STTZN	363 000	132		819 760	196
EL16 L5.05M 1KSO 8.10 1KSG 10	416 451	259	ESS 3P M10X35 STTZN	465 801	263	FM D30 L2300 DBS R320 GFK AL STTZN		
EL16 L5.05M 1KSO 8.10 1KSG 8	416 450	259	ESS 5P M10X35 STTZN	466 192	263		819 282	145
EL16 L5.05M 2KSO 8.10	416 050	256	ESTK 8.10 ZG	463 010	76	FM D30 L2800 DBS R320 GFK AL STTZN		
EL16 L5.05M 2KSO 8.10 GG	417 050	257	ESTV 8 RG	310 008	76		819 287	145
EL16 L50.05M 2KSO 8.10 GG	417 150	257	ESV 8 RG	309 087	76	FM D50 10 2900 GFK AL DBS KB STTZN		
EL16 L6.05M 2KSO 8.10	416 060	256	ESV 8 ZG	309 008	76		819 380	146
EL16 L7.05M 2KSG 10	416 970	260	EWD MVK8.10 M10 L100 300 V4A	478 410	130	FM D50 16 10 3900 GFK AL DBS KB STTZN		
EL16 L7.05M 2KSO 8.10	416 070	256	EWD MVK8.10 M10 L300 500 V4A	478 430	130		819 385	146
EL16 L8.05M 2KSO 8.10	416 080	256	EWD MVK8.10 M10 L500 700 V4A	478 450	130	FM D50 22 16 10 4900 GFK AL DBS KB STTZN		
EMG GEOHM C	578 110	289	EX BRS 27	540 821	279		819 390	146
EMG METREL MI 3123	578 351	289	EX BRS 300	540 803	279	FP D80 ET70 8.10 V2A	108 009	113
EMKO ML EB PK ... KL	582 600	291	EX BRS 500	540 805	279	FR A6 V2A	524 906	285
EMZ M312N METRACLIP EARTH	578 386	290	EX BRS 90	540 801	279	FRH 11 6.10 WA11 B7 CU	277 237	54
ERO BSP ASSM10 1000 STTZN	644 000	263	EXFS 100	923 100	286	FRH 11 6.10 WA11 B7 STTZN	277 230	54
ERO SSP ASSM8 600 STTZN	646 000	246	EXFS 100 KU	923 101	287	FRH 11 6.10 WA11 B7 V2A	277 239	54
ERS 17 AB11 V2A	410 309	274	EXFS KU	923 019	286	FRH 11 6.10 WA15 B7 STTZN	277 240	54
ERS 17 AB11 STTZN	410 038	274	EXFS L100	923 060	286	FS 10 1000 AL	101 000	95
ERS 21 AB11 STTZN	410 012	274	EXFS L200	923 061	286	FS 10 1000 CU	101 007	95
ERS 21 AB11 V2A	410 319	274	EXFS L300	923 062	286	FS 10 1000 FG AL V2A	123 109	110
ERS 21 AS4.10 TG STTZN	407 012	273	EZ 16 FL13 ASM6 STGALZN	546 025	277	FS 10 1000 M10 V2A	101 001	121
ERS 27 AB11 STTZN	410 034	274	EZ 16 FL13 ASM6 V2A	546 002	277	FS 10 1000 V2A	101 009	95
ERS 27 AB11 V2A	410 329	274	EZ 55 FL45 ASM10 STGALZN	546 000	277	FS 16 10 1500 AL	103 210	95
ERS 27 AS4.10 TG STTZN	407 034	273	EZ 55 FL45 ASM10 V2A	546 001	277	FS 16 10 1660 GFK AL	106 207	121
ERS 34 AB11 STTZN	410 100	274				FS 16 10 2000 AL	103 220	95

Type	Part No.	Page	Type	Part No.	Page	Type	Part No.	Page
FS 16 10 2000 GFK AL	106 210	121	FS D40 22 16 10 8500 KSV V2A	105 199	101	HE TE 20 TES VH HI STBLANK	620 031	251
FS 16 10 2000 MD AL V2A	123 021	109	FS D40 22 16 10 9000 AL DBS KB STTZN			HE TE 25 R27 LVH WN STBLANK	625 009	250
FS 16 10 2000 TD AL V2A K	123 032	110		105 900	98	HE TE 25 R27 VH WN STBLANK	625 005	249
FS 16 10 2500 AL	103 230	95	FS D60 10 10M AL SBS STTZN	105 910	99	HE TE 25 SDS MAX VH STBLANK	625 030	251
FS 16 10 3000 AL	103 240	95	FS D60 10 11M AL SBS STTZN	105 911	99	HE TE 25 SW22 VH AC STBLANK	625 007	250
FS 16 10 3500 AL	103 250	95	FS M16 10 1500 AL	103 211	96	HE TE 25 SW25 VH AC STBLANK	625 008	250
FS 16 10 4000 AL	103 260	95	FS M16 10 2000 AL	103 221	96	HE TE 25 SW28 VH AC STBLANK	625 019	250
FS 16 10 5000 AL	103 280	95	FS M16 10 2500 AL	103 231	96	HE TE 25 SW28 VH BO STBLANK	625 029	251
FS 16 1000 STTZN	483 100	95	FS M16 10 3000 AL	103 241	96	HE TE 25 SW32 VH AC STBLANK	625 010	250
FS 16 1250 STTZN	483 125	95	FS M16 10 3500 AL	103 251	96	HE TE 25 TES VH HI STBLANK	625 031	251
FS 16 1500 AL	104 150	95	FS M16 10 4000 AL	103 261	96	HG TE VH STTZN	600 003	253
FS 16 1500 STTZN	483 150	57	FSA KT16 B16 95 STTZN V2A	106 008	112	HP 90X90 2400 EHI	145 241	39
FS 16 2000 AL	104 200	95	FSK 2X8.10 16 FRM10X50 AL	380 116	88	HSC 8X32 AGM8X13 STGALZN	528 850	55
FS 16 2000 STTZN	483 200	57	FSK 3X8.10 FRM10X50 AL	380 110	88	HSC 8X42 AGM8X13 STGALZN	528 870	55
FS 16 2500 AL	104 250	95	FSK 8.10 16 SKM10X25 STTZN	380 020	89	HSPD HS4.5 L50 PA	200 600	55
FS 16 3000 AL	104 300	95	FSK 8.10 16 SKM10X25 V2A	380 029	89	HSPD HS4.5 L85 PA	200 601	55
FS 16 6000 AL	104 600	96	FSP 10 1000 MVK 8.10 V2A	105 071	121	HVI 20 M L6M SR1955 FS2500 DSH GFK AL		
FS 22 16 10 2500 AL DBS R320 STTZN	105 525	97	FSP 10 1000 W55 AL	101 010	112		819 247	160
FS 22 16 10 2500 SK AL V2A	123 425	109	FSPS 10 1000 W55 FK AL	101 110	112	HVI 20 M L6M SR3200 IP FSP1000 GFK AL		
FS 22 16 10 3000 AL DBS R320 STTZN	105 530	97	FSS 16 1000 KS STTZN	100 100	96		819 326	170
FS 22 16 10 3000 SK AL V2A	123 430	109	FSS 16 1500 KS STTZN	100 150	96	HVI 20 M L6M SR3200 IP RFS2500 GFK AL		
FS 22 16 10 3500 AL DBS R320 STTZN	105 535	97	FTS 8.10 FL30.40 IS STTZN	453 100	66		819 328	170
FS 22 16 10 3500 SK AL V2A	123 435	109				HVI 20 M L6M SR4700 IP RFS2500 GFK AL		
FS 7.10 ZG	110 000	113	GAD EFP M10 10 L130 V4A	478 699	133		819 426	170
FS 8 MSGALCU	110 017	113	GMA 250 2000X1000X4 V4A	618 214	220	HVI 20M L6M SR3200 SA FSP1000 AL DBS V2A		
FS D100 10 12M AL DBS STTZN	105 922	100	GP B10 H60 D300 KS GR	253 300	122		819 371	170
FS D100 10 13M AL DBS STTZN	105 923	100	GSS 3 M16X340 V2A	105 396	178	HVI 20M L6M SR3200 SA RFS2500 AL DBS V2A		
FS D100 10 14M AL DBS STTZN	105 924	100	GSS 3 M16X520 V2A	105 397	178		819 373	171
FS D40 16 10 4000 AL DBS KB STTZN	105 400	98	GSS 3 M16X650 V2A	105 398	178	HVI 20M L6M SR4700 SA RFS2500 AL DBS V2A		
FS D40 16 10 4000 KSV AL	105 170	101	GSS 4 M16X340 V2A	105 496	178		819 473	171
FS D40 16 10 4000 KSV V2A	105 190	101	GSS 4 M16X520 V2A	105 497	178	HVI 23 L6M SR3200 IP FSP1000 GFK AL		
FS D40 16 10 5000 AL DBS KB STTZN	105 500	98	GSS 4 M16X650 V2A	105 498	178		819 336	170
FS D40 16 10 5000 KSV AL	105 171	101				HVI 23 L6M SR3200 IP RFS2500 GFK AL		
FS D40 16 10 5000 KSV V2A	105 191	101	HA 10 1F FG120.300 V2A	123 110	111		819 338	170
FS D40 16 10 6000 AL DBS KB STTZN	105 600	98	HA 16 2F FG120.300 V2A	123 116	111	HVI 23 L6M SR3200 SA FSP1000 AL DBS V2A		
FS D40 16 10 6000 KSV AL	105 172	101	HA M8 AL ZF B5.2 6.5 V2A	123 043	104		819 381	170
FS D40 16 10 6000 KSV V2A	105 192	101	HA M8 KF18.22 V2A	123 041	104	HVI 23 L6M SR3200 SA RFS2500 AL DBS V2A		
FS D40 16 10 7000 AL DBS KB STTZN	105 700	98	HA M8 RSF20.25 V2A	123 040	104		819 383	171
FS D40 16 10 7000 KSV AL	105 173	101	HA M8 SF0.7 8 V2A	123 042	104	HVI 23 L6M SR4700 IP RFS2500 GFK AL		
FS D40 16 10 7000 KSV V2A	105 193	101	HA VH AT	600 029	253		819 438	170
FS D40 16 10 8000 AL DBS KB STTZN	105 800	98	HA VH BO	600 050	253	HVI 23 L6M SR4700 SA RFS2500 AL DBS V2A		
FS D40 16 10 8000 KSV AL	105 174	101	HA VH WA	600 035	253		819 483	171
FS D40 16 10 8000 KSV V2A	105 194	101	HE RE 25 R27 VH WN STBLANK	648 005	251	HVI CUTTER 32	597 032	151
FS D40 22 16 10 4500 AL DBS KB STTZN			HE RE 25 SDS MAX VH STBLANK	648 009	252	HVI HEAD 20	597 120	151
	105 450	98	HE RE 25 SW22 VH AC STBLANK	648 007	251	HVI HEAD 27	597 127	212
FS D40 22 16 10 4500 KSV AL	105 175	101	HE RE 25 SW28 VH BO STBLANK	648 029	252	HVI HH	597 139	151
FS D40 22 16 10 4500 KSV V2A	105 195	101	HE RE 25 TES VH HI STBLANK	648 031	252	HVI LI 20 L6M SR1990 FSP1000 GFK AL V2A		
FS D40 22 16 10 5500 AL DBS KB STTZN			HE RE 27 R27 VH WN STBLANK	649 005	251		819 256	156
	105 550	98	HE RE 27 SDS MAX VH STBLANK	649 009	252	HVI LI 20 L6M SR1990 FSP500 GFK AL V2A		
FS D40 22 16 10 5500 KSV AL	105 176	101	HE RE 27 SW22 VH AC STBLANK	649 007	251		819 255	156
FS D40 22 16 10 5500 KSV V2A	105 196	101	HE RE 27 SW28 VH BO STBLANK	649 029	252	HVI LI 20 L6M SR2640 FSP1000 GFK AL V2A		
FS D40 22 16 10 6500 AL DBS KB STTZN			HE RE 27 TES VH HI STBLANK	649 031	252		819 258	156
	105 650	98	HE TE 20 R27 LVH WN STBLANK	620 009	250	HVI LI 20 L6M SR2640 FSP500 GFK AL V2A		
FS D40 22 16 10 6500 KSV AL	105 177	101	HE TE 20 R27 VH WN STBLANK	620 005	249		819 257	156
FS D40 22 16 10 6500 KSV V2A	105 197	101	HE TE 20 SDS MAX VH STBLANK	620 030	251	HVI LI 20 L6M SR2875 FSP1000 DSH GFK AL		
FS D40 22 16 10 7500 AL DBS KB STTZN	105 750	98	HE TE 20 SW22 VH AC STBLANK	620 007	250		819 243	159
FS D40 22 16 10 7500 KSV AL	105 178	101	HE TE 20 SW25 VH AC STBLANK	620 008	250	HVI LI 20 L7.5M SR5040 FSP500 GFK AL V2A		
FS D40 22 16 10 7500 KSV V2A	105 198	101	HE TE 20 SW28 VH AC STBLANK	620 019	250		819 259	156
FS D40 22 16 10 8500 AL DBS KB STTZN	105 850	98	HE TE 20 SW28 VH BO STBLANK	620 029	251	HVI LI 45 20 L .. GR	819 129	144
FS D40 22 16 10 8500 KSV AL	105 179	101	HE TE 20 SW32 VH AC STBLANK	620 010	250	HVI LI 45 20 L100M GR	819 125	144

Type	Part No.	Page	Type	Part No.	Page	Type	Part No.	Page
HVI LI 45 20 L500M GR	819 124	144	KS 7.10 B10.5 AL	347 205	88	LH DFI DQ 6.10 V2A H30 GR	250 001	46
HVI LI AE M12 AB10X50	819 299	144	KS 798 PAS	563 018	267	LH DG 8 H20 B7.8 CU	207 007	45
HVI LI ASS RIV 20 GFB1000	819 271	157	KS 8 B11 STTZN	345 008	88	LH DG 8 H20 B7.8 V2A	207 009	45
HVI LI ASS RIV 20 GFB2200	819 272	157	KS 8.10 16 FL30 STTZN	318 252	80	LH DG 8 H20 H55X50 KD8 CU BR	207 107	45
HVI LO 75 20 L... SW M	819 131	160	KS 8.10 16 FL30 ZP STTZN	319 202	79	LH DG 8 H20 H55X50 KD8 V2A GR	207 109	45
HVI LO 75 20 L100M SW M	819 135	172	KS 8.10 16 FL30 ZP V4A	319 219	79	LH DG 8 H20 IGM6 CU	207 017	45
HVI LO 75 23 L... GR	819 132	172	KS 8.10 8.10 FL30 OV CU	314 307	78	LH DG 8 H20 IGM6 V2A	207 019	45
HVI LO 75 23 L100M GR	819 136	172	KS 8.10 8.10 FL30 OV STTZN	314 300	78	LH DG 8 H32 B7.8 CU	207 027	45
HVI LO ASS RAV 23	819 148	173	KS 8.10 8.10 FL30 OV ZP STTZN	314 310	78	LH DG 8 H32 B7.8 V2A	207 029	45
HVI LO ASS RAV MM 20	819 146	173	KS 8.10 8.10 FL30 STTZN	318 251	80	LH DG 8 H32 IGM6 CU	207 037	45
HVI LO ASS RIV 20	819 145	161	KS 8.10 8.10 FL30 V4A	318 219	80	LH DG 8 H32 IGM6 V2A	207 039	45
HVI LO ASS RIV 23	819 147	173	KS 8.10 8.10 FL30 ZP CU	319 207	79	LH DQ 6.10 ND6X60 V2A	390 120	49
HVI P 27 L6M SR3500 FS2500 GFK V2A			KS 8.10 8.10 FL30 ZP FRSM8 STTZN	318 203	80	LH DQ 6.10 ND8X80 STTZN	390 121	49
	819 431	196	KS 8.10 8.10 FL30 ZP FRSM8 V4A	318 229	80	LH DQ 6.10 ND8X80 V2A	390 122	49
HVI P 27 L6M SR3500 FSP1000 GFK V2A			KS 8.10 8.10 FL30 ZP STTZN	319 201	79	LH DS 8 H16 H55X50 GR	204 006	46
	819 430	196	KS 8.10 8.10 FL30 ZP V4A	319 209	79	LH DS 8 H16 H55X50 KD8 GR	204 120	46
HVI P 27 L6M SR5000 FS2500 GFK V2A			KS 8.10 FL30 CU	318 207	79	LH DS 8 H16 IGM6 BR	204 007	45
	819 433	196	KS 8.10 FL30 FRSM8 STTZN	318 205	81	LH DS 8 H16 IGM6 GR	204 001	45
HVI P LO 90 27 L100M SW	819 137	197	KS 8.10 FL30 FRSM8 V4A	318 239	81	LH DS 8 H16 IGM8 BR	204 017	45
HVI P LO 90 27 L36...80M SW	819 161	197	KS 8.10 FL30 STTZN	318 201	79	LH DS 8 H16 IGM8 GR	204 002	45
HVI P LO 90 27 L6...35M SW	819 163	197	KS 8.10 FL30 V4A	318 209	79	LH DS 8 H36 IGM6 BR	204 027	45
HVI P LO ASS 27	819 142	198	KS 8.10 FL40 CU	321 047	79	LH DS 8 H36 IGM6 GR	204 003	45
HVI P LO ASS RAV 27	819 149	198	KS 8.10 FL40 STTZN	321 045	79	LH DS 8 H36 IGM8 BR	204 037	45
HVI P RAV 90 27 L6M SW	819 165	197	KS B11.11 FL30X4 V2A	380 129	88	LH DS 8 H36 IGM8 GR	204 004	45
HVI P RIV 90 27 L6M SW	819 160	197	KS FL30 STTZN	318 033	80	LH FS 8 H16 GR V2A	204 029	33
HVI RAV 75 20 L6M SW M	819 226	172	KS FL30 V4A	318 233	80	LH FS 8 H16 K BR V2A	204 039	33
HVI RAV 75 23 L6M GR	819 227	172	KS FL40 STTZN	320 044	80	LH KD 8.10 D76 STTZN	425 076	276
HVI RIV 75 20 L6M SW M	819 220	172	KSB 100 L10M	556 130	221	LH KD 8.10 D89 STTZN	425 089	276
HVI RIV 75 23 L6M GR	819 223	172	KSB 50 L10M	556 125	221	LH KP 6.10 VKS70 STTZN	260 118	49
HVI STRIP 20	597 220	150	KSS M6X16 V2A	490 020	70	LH KR 6.10 H22 B6.5 V2A	273 019	49
HVI STRIP 27	597 227	212	KSS SW10 13 17 19 STGALZN	572 000	294	LH PS 8 H16 KB4.6 BR V2A	204 079	37
HWS 297X210 ABS DE EN AL	480 698	219	KSV 200 10 FER V2A	301 209	94	LH PS 8 H16 KB4.6 GR V2A	204 069	37
HWS 297X210 AGU3MV DE EN AL	480 699	219	KSV 2X7.10 STTZN	302 010	52	LH US 8 H16 L205 KT GR V2A	204 089	34
HWS 300X200 AGBS HVI DE EN K	480 598	186	KSV 6.10 CU	301 007	51	LH ZG 8 H20 KB4.16 V2A	206 049	37
HWS 70X30 APA DE EN K	480 599	186	KSV 6.10 FER CU	301 017	51	LH ZS 13 IGM8 STTZN ZG	275 113	48
			KSV 6.10 FER V2A	301 019	51	LH ZS 13 M8 V2A	274 113	47
IS PAS M10	472 210	269	KSV 6.10 FER V4A	301 099	51	LH ZS 16 M8 V2A	274 116	61
			KSV 6.10 V2A	301 009	51	LH ZS 16 SBB PA V2A	275 716	52
KÖFU I TBM FP400	103 030	108	KSV 6.10 V4A	301 089	51	LH ZS 20 23 B5.5X10 V2A	275 252	150
KÖFU II TBM FP565	103 031	108	KSV 7.10 FER STTZN	301 010	51	LH ZS 20 23 DS10 L75 V2A	253 289	147
KB 6.10 B9 STTZN	390 110	49	KSV 7.10 STTZN	301 000	51	LH ZS 20 23 GM6 V2A	275 251	150
KB 6.10 B9 V2A	390 119	49	KSV 8.12.5 CU	300 017	51	LH ZS 20 23 GM8 V2A	275 250	150
KB 6.10 FRM10X35 CU	390 157	51	KSV 8.12.5 STTZN	300 002	51	LH ZS 20 23 KS H10 V2A	275 259	150
KB 6.10 FRM10X35 STTZN	390 150	51	KV FE UNI	308 001	244	LH ZS 20 23 KT D16 L85 V2A	253 279	148
KB 6.10 FRM10X35 V2A	390 159	51				LH ZS 20 23 SB50.300 V2A	275 320	184
KFSU	923 021	276	LH 6.13 FL30 B10 K GR	277 130	278	LH ZS 20 23 SBH 25X0.3 V2A	275 319	185
KLA 8 FB KF K SW	253 025	26	LH 6.8 SB50.120 SPSM8 CU	200 027	50	LH ZS 20 EX P200 SBB V2A	275 442	187
KP AQ4 50 DUL 8.10 VKL11 V2A	540 261	275	LH 6.8 SB50.120 SPSM8 V2A	200 029	50	LH ZS 20 EX P70 SBB V2A	275 444	187
KP AQ4 50 DUL 8.10 VKL9 V2A	540 251	275	LH 6.8 SB50.150 SPSM8 V2A	200 039	50	LH ZS 20 EX W200 BP V2A	275 441	187
KRA 6.10 STTZN	538 010	53	LH 7.10 BB16 V2A ZG	106 128	117	LH ZS 20 EX W70 BP V2A	275 440	186
KRA FL30 STTZN	538 030	55	LH 8 SB100 SCL CU	200 057	50	LH ZS 20 H10 B6.5X16 V2A	275 229	186
KS 10 B11 STTZN	345 010	88	LH 8 SB100 SCL V2A	200 059	50	LH ZS 20 H19 IGM8 GR PA	275 220	150
KS 16 8.10 FL30 OV ZP CU	316 167	78	LH 8 SB100.120 SCG GALCU	200 087	50	LH ZS 20 SB50.300 PA V2A	275 330	184
KS 16 8.10 FL30 OV ZP STTZN	316 163	78	LH 8 SB100.120 SCG V2A	200 089	50	LH ZS 23 H10 B6.5X16 V2A	275 239	186
KS 198 PAS	563 016	267	LH 8 SB80.100 SCG GALCU	200 077	50	LH ZS 23 H19 IGM8 GR PA	275 225	186
KS 200 B11.11 FL30X4 V2A	380 209	94	LH 8 SB80.100 SCG V2A	200 079	50	LH ZS 23 SB50.300 PA V2A	275 333	184
KS 35 14 B8.5 UVS BR	276 017	48	LH 8 SB80.100 SCL CU	200 067	50	LH ZS 27 30 SBH 25X0.3 V2A	275 359	207
KS 35 14 B8.5 UVS GR	276 016	48	LH 8 SB80.100 SCL V2A	200 069	50	LH ZS 27 B5.5X10 V2A	275 242	207
KS 398 PAS	563 017	267	LH DFI DQ 6.10 CU H30 BR	250 007	46	LH ZS 27 DS10 L75 V2A	253 330	205
KS 7.10 7.10 FL40 ZP V4A	319 229	79	LH DFI DQ 6.10 STTZN H30 GR	250 000	46	LH ZS 27 EX P240 SBB V2A	275 455	210

Type	Part No.	Page	Type	Part No.	Page	Type	Part No.	Page
LH ZS 27 EX P85 SBB V2A	275 454	210	MVK 8.10 16 FRM10X40 STTZN	392 060	74	PAS I 10AP M10 CU	472 217	268
LH ZS 27 EX W240 BP V2A	275 451	209	MVK 8.10 16 FRM10X40 V2A	392 069	74	PAS I 10AP M10 V2A	472 219	268
LH ZS 27 EX W85 BP V2A	275 450	209	MVK 8.10 16 SKM10X40 FSC STTZN	392 050	74	PAS I 12AP M10 CU	472 237	268
LH ZS 27 GM6 V2A	275 241	207	MVK 8.10 16 SKM10X40 FSC V2A	392 059	74	PAS I 12AP M10 V2A	472 239	268
LH ZS 27 GM8 V2A	275 240	207	MVK 8.10 FRM10X35 AL	390 061	73	PAS I 6AP M10 CU	472 207	268
LH ZS 27 KS H10 V2A	275 249	207	MVK 8.10 FRM10X35 STTZN	390 060	73	PAS I 6AP M10 V2A	472 209	268
LH ZS 27 KT D16 L85 V2A	253 331	205	MVK 8.10 FRM10X35V2A STTZN	390 063	73	PAS I 8AP M10 CU	472 227	268
LH ZS 27 SB50.300 V2A	275 339	207	MVK 8.10 M10 V2A	105 079	121	PAS I 8AP M10 V2A	472 229	268
LH ZS 6.11 FL30 SBB PA V2A	275 730	52	MVK 8.10 SKM10X30 AL	390 051	73	PK 2.21 ASSM5 TGTZN	588 000	291
LH ZS 6.11 SBB PA V2A	275 711	52	MVK 8.10 SKM10X30 FSC AL	390 551	73	PK 4.45 ASSM5 TGTZN	589 000	291
LH ZS 7.10 AB D10X140 STTZN ZG	273 740	49	MVK 8.10 SKM10X30 FSC STTZN	390 550	73	PSE 50X50X3 1000 STTZN	635 100	246
LH ZS 7.10 AB D10X180 STTZN ZG	273 741	49	MVK 8.10 SKM10X30 FSC V2A	390 559	73	PSE 50X50X3 1500 STTZN	635 150	246
LH ZS 7.10 AB D10X240 STTZN ZG	273 742	49	MVK 8.10 SKM10X30 STTZN	390 050	73	PSE 50X50X3 2000 STTZN	635 200	246
LH ZS 7.10 FL20 LRS100 STTZN	262 100	48	MVK 8.10 SKM10X30 V2A	390 059	73	PSE 50X50X3 2500 STTZN	635 250	246
LH ZS 7.10 FL20 LRS70 STTZN	262 070	48	MVK 8.10 SKM10X35 V4A	390 079	73	PV 4.10 SKM8X30 CU	305 007	77
LH ZS 7.10 FL20 VKS100 CU	260 187	48				PV 4.10 SKM8X30 STTZN	305 000	77
LH ZS 7.10 FL20 VKS100 STTZN	260 108	48	NS 16 OZ AL	480 004	71	PV 5.12.5 SKM8X45 CU	306 100	77
LH ZS 7.10 FL20 VKS150 STTZN	260 158	48	NS 7.10 FL30 OZ AL	480 003	71	PV 5.12.5 SKM8X45 GSG CUGALSN	306 105	280
LH ZS 7.10 FL20 VKS70 STTZN	260 708	48	NS SOB 0.9	490 999	69	PV 5.16 SKM10X50 CU	306 101	77
LH ZS 7.10 FL30 AS KD8X40 V2A	286 819	47	NS SOB L	490 099	70	PV 5.16 SKM10X50 GSG CUGALSN	306 106	280
LH ZS 7.10 IGM8 STTZN ZG	275 110	47	NSE 0 V2A	490 000	70	PV 6.22 FRM10X40 STBLANK	306 121	77
LH ZS 7.10 KD8X40 STTZN ZG	275 160	47	NSE 1 V2A	490 001	70	PV 6.22 FRM10X40 STTZN	306 122	77
LH ZS 8 H16 KB4.16 BR V2A	204 059	37	NSE 2 V2A	490 002	70	PV 7.10 FRM10X35 STTZN	306 020	77
LH ZS 8 H16 KB4.16 GR V2A	204 049	37	NSE 3 V2A	490 003	70	PV 7.10 FRM10X35 V4A	306 029	77
LH ZS 8.10 FL20 KS KD8X40 CU	274 167	47	NSE 4 V2A	490 004	70	PV 7.10 SKM8X20 CU	307 007	77
LH ZS 8.10 FL20 KS KD8X40 V2A	274 160	47	NSE 5 V2A	490 005	70	PV 7.10 SKM8X20 STTZN	307 000	77
LH ZS 8.10 FL20 M8 CU	274 117	46	NSE 6 V2A	490 006	70			
LH ZS 8.10 FL20 M8 KS CU	274 150	46	NSE 7 V2A	490 007	70	RD 10 AI WEI R100M	840 010	19
LH ZS 8.10 FL20 M8 V2A	274 110	46	NSE 8 V2A	490 008	70	RD 10 KM STTZN R50M	800 110	20
LH ZSUEL 20 2XB6.5 V2A	275 129	218	NSE 9 V2A	490 009	70	RD 10 STTZN L3000	800 910	20
			NSE BLANK AL	490 900	70	RD 10 STTZN L6000	800 911	20
MAMVK 8.16 15.25 STBL	308 040	75	NST 16 ON AL	490 116	69	RD 10 STTZN R30M	800 310	20
MAMVK 8.16 15.25 STTZN	308 041	75	NST 7.10 FL30 ON AL	490 110	69	RD 10 STTZN R81M	800 010	20
MDH D48 VB550.900 V2A	105 241	104	NST ON AL	490 100	69	RD 10 V2A R20M	860 920	20
ML 0.75 L100M CU BL	545 000	292				RD 10 V2A R50M	860 950	20
ML 0.75 L100M CU RT	545 001	292	OENTK 7.10 7.10 ZG	460 213	92	RD 10 V2A R80M	860 910	20
MMVK 3.5 8.10 SKM8X30 STBLANK	390 565	74				RD 10 V4A R20M	860 020	20
MMVK 3.5 8.10 SKM8X30 V4A	540 271	74	PAE 17 20 AB11 V2A	410 219	144	RD 10 V4A R50M	860 050	20
MMVK 6.8 FRM10X35 CU	390 257	74	PAE 20 23 AB11 V2A	410 229	174	RD 10 V4A R80M	860 010	20
MMVK 6.8 FRM10X35 STTZN	390 250	74	PAE 27 AB11 V2A	410 239	198	RD 8 AL CU WEI R110M	833 008	19
MMVK 6.8 FRM10X35 V2A	390 259	74	PAK 20 AQ4 95 STTZN	405 020	183	RD 8 AL WE KM R100M	840 128	19
MPE S 35 ER	306 230	285	PAK 35 M6 EX KB ER	306 204	284	RD 8 ALMGSI HH R148M	840 008	19
MPE S 50/70 ER	306 231	285	PAK 35 M8 EX GI ER	306 203	284	RD 8 ALMGSI HH R21M	840 108	19
MS 37 4.7 B7.5 K BR	276 057	21	PAK 35 M8 EX KB ER	306 200	284	RD 8 ALMGSI WE KM R100M	840 118	19
MS 37 4.7 B7.5 K GR	276 056	21	PAK 50 M6 EX KB ER	306 205	284	RD 8 ALMGSI WEI R148M	840 018	19
MSC MDH V4A L1000 MZ V2A	123 050	105	PAK 50 M8 EX KB ER	306 201	284	RD 8 ALMGSI WEI R21M	840 028	19
MSC MDH V4A L1500 MZ V2A	123 051	105	PAK 70 M6 EX KB ER	306 206	284	RD 8 CU F20 WEI R100M	830 008	19
MSC MDH V4A L2000 MZ V2A	123 052	105	PAK 70 M8 EX KB ER	306 202	284	RD 8 CU F20 WEI R20M	830 108	19
MVK 10 FRM10X35 STTZN	391 060	73	PAP 1 EX GI ER	306 212	285	RD 8 CU F25 HH R100M	830 038	19
MVK 10 FRM10X35 V2A	391 069	73	PAP 1 EX KB ER	306 210	284	RD 8 KM STTZN R75M	800 108	20
MVK 10 SKM10X35 FSC STTZN	391 550	73	PAP 2 EX GI ER	306 213	285	RD 8 STTZN R127M	800 008	20
MVK 10 SKM10X35 FSC V2A	391 559	73	PAP 2 EX KB ER	306 211	284	RD 8 V2A R125M	860 908	20
MVK 10 SKM10X35 STTZN	391 050	73	PAS 11AK	563 200	265	RD 8 V4A R125M	860 008	20
MVK 10 SKM10X35 V2A	391 059	73	PAS 11AK UV	563 201	265	RE 25 1500 V4A	649 150	246
MVK 16 16 FRM10X50 V2A	393 069	120	PAS 6RK OH	563 105	265	RE 27 1500 STTZN	640 150	246
MVK 200 8.10 16 SKM10X40 FSC V2A	392 209	94	PAS 9AK	563 050	265	RE G 8.10 FL4 STBRUE	596 000	293
MVK 200 8.10 SKM10X30 V2A	390 209	94	PAS AH RK 13X25 1X8.10	563 030	266	RE GK 8.10 SW13 STBRUE	595 000	293
MVK 8 FRM10X35 CU	390 067	73	PAS AH RK 5X25 3X8.10 1XFL30	563 020	266	RFS 16 10 1500 AL	103 410	96
MVK 8 SKM10X30 CU	390 057	73	PAS AH RK 7X25 2X8.10 1XFL30	563 010	266	RFS 16 10 1500 CU	103 417	96
MVK 8 SKM10X30 FSC CU	390 557	73	PAS AH RK 7X25 2X8.10 1XFL40	563 040	266	RFS 16 10 1500 V2A	103 419	96

Type	Part No.	Page	Type	Part No.	Page	Type	Part No.	Page
RFS 16 10 2000 AL	103 420	96	SH ZS 16 KD8X40 STTZN ZG	275 260	62	SR D50 4700 FS1000 IP SA HVI GFK V2A		
RFS 16 10 2000 V2A	103 429	96	SH ZS 16 KS KD8X40 V2A	274 260	61		105 338	175
RFS 16 10 2500 AL	103 430	96	SH ZS 16 M8 V2A	275 116	62	SR D50 4700 FS22 2500 IP HVI GFK AL		
RFS 16 10 2500 V2A	103 439	96	SH ZS 16 VKS100 STTZN	260 106	62		105 333	175
RFS 16 10 3000 AL	103 440	96	SK RD10 FL30X3.5 GRGE PVC	478 099	21	SR D50 4700 FS22 2500 IP HVI GFK V2A		
RFS 16 10 3000 V2A	103 449	96	SKM M6 DIN 934 V2A	505 901	285		105 317	175
RFS 16 10 3500 AL	103 450	96	SKO TE 20 STBLANK	620 002	252	SR D50 4700 FS2500 IP SA HVI GFK AL		
RFS 16 10 4000 AL	103 460	96	SKO TE 25 STBLANK	625 002	252		105 328	176
RFS 16 10 5000 AL	103 480	96	SM SS M6 ER	306 240	285	SR D50 4700 FS2500 IP SA HVI GFK V2A		
RK 16 PAS	563 011	267	SPB 14X0.3 L100M V2A	540 905	52		105 339	176
RK 95 PAS	563 013	267	SPB 14X0.3 L50M V2A	540 931	52	SR D50 4700 FSP1000 IP HVI GFK AL	105 332	175
RK FL30 PAS	563 012	267	SPB 25X0.3 L100M V2A	540 901	120	SR D50 4700 FSP1000 IP HVI GFK V2A	105 316	175
RK FL40 PAS	563 019	267	SPK 100X100 FSP10 300 7.10 V2A	146 309	39	SR D50 5000 FS1000 IP SA HVIP GFK V2A		
RLA 10 FB KF K SW	253 023	25	SPK 14X0.3 V2A	540 930	52		105 394	199
RLA 20 FB K SW	253 026	147	SPK 25 BRS AQ4 25 V2A	540 900	271	SR D50 5000 FS22 10 2500 IP HVIP GFK V2A		
RLA 23 FB K SW	253 027	181	SPK 25 BRS AK1X10 2X6.8 V2A	540 110	262		105 323	198
RRS 100 B11 CU	420 107	50	SPK 25X0.3 V2A	106 324	119	SR D50 5000 FS2500 IA HVIP GFK AL	105 575	198
RRS 100 B11 STTZN	420 100	50	SPK 27.89 BRS AK1X10 2X6.8 GSG V2A			SR D50 5000 FS2500 IA SA HVIP GFK AL		
RRS 120 B11 CU	420 127	50		540 199	280		105 545	199
RRS 120 B11 STTZN	420 120	50	SPK Z 25 BRS AK1X10 2X6.8 V2A	540 210	273	SR D50 5000 FS2500 IP SA HVIP GFK V2A		
RRS V 60.100 B10.5 AL	423 011	50	SR D30 1990 FSP10 1000 GFK AL V2A	105 273	157		105 395	199
RRS V 60.100 B10.5 CU	423 017	50	SR D30 1990 FSP10 500 GFK AL V2A	105 272	157	SR D50 5000 FSP1000 IA HVIP GFK AL	105 565	198
RRS V 60.100 B10.5 STTZN	423 010	50	SR D30 2640 FSP10 1000 GFK AL V2A	105 280	157	SR D50 5000 FSP1000 IA SA HVIP GFK AL		
RRS V 60.100 B10.5 V2A	423 019	50	SR D30 2840 FSP10 500 GFK AL V2A	105 274	157		105 515	199
RRS V 60.150 B10.5 AL	423 021	50	SR D30 2875 FSP10 1000 DSH GFK AL V2A			SR D50 5000 FSP1000 IP HVIP GFK V2A		
RRS V 60.150 B10.5 CU	423 027	50		105 288	159		105 322	198
RRS V 60.150 B10.5 STTZN	423 020	50	SR D50 1950 FS22 16 10 2500 DSH GFK AL			SR D50 M10 3200 GFK AL	105 300	124
RRS V 60.150 B10.5 V2A	423 029	50		105 281	160	SR D50 M10 4700 GFK AL	105 301	124
RS D40.60 BB16 V2A ZG	106 352	118	SR D50 3200 FS1000 IP SA HVI GFK AL			SR D50 M10 6200 TB GFK AL	105 302	124
RS D70.90 BB16 V2A ZG	106 353	118		105 325	175	SR IPA 1L	297 199	42
RTUP 230X180 SV STTZN	476 100	68	SR D50 3200 FS1000 IP SA HVI GFK V2A			SSP D90 H20	478 098	130
RTUP 230X180 VKS STTZN	476 001	68		105 336	175	SSP TE 20 TGTZN	620 001	245
RTUP 290X230 VKS V2A	476 020	68	SR D50 3200 FS16.10 2500 GFK AL	105 306	124	SSP TE 25 TGTZN	625 001	245
SB PAS RK	563 014	267	SR D50 3200 FS22 2500 IP HVI GFK AL			STS HUK 8.4X130 PLDI AGM10X50 V2A		
SBD 60 PAK 35 EX ER	306 220	285		105 331	175		528 820	105
SCK EX BRS ASSM10 V2A	540 810	279	SR D50 3200 FS22 2500 IP HVI GFK V2A			STS HUK 8.4X130 PLDI AGM10X50 V2A		
SCSC 16 FL30 L...M SW	554 011	294		105 315	175		528 820	162
SEIL 10 STGALZN R100M	801 050	22	SR D50 3200 FS2500 IP SA HVI GFK AL			STS SUK 8X125 PLDI AGM10X50 V2A	528 821	105
SEIL 10 V4A R100M	850 010	22		105 326	176	SVK 6.28 FL30 STBL	308 062	81
SEIL 10.5 70Q CU R100M	832 193	23	SR D50 3200 FS2500 IP SA HVI GFK V2A			SVK 7.10 16 FL40 STTZN	308 330	82
SEIL 10.5 70Q CU R50M	832 192	23		105 337	176	SVK 7.10 7.10 FL30 STTZN	308 220	81
SEIL 10.5 70Q CUGALSN R100M	832 292	23	SR D50 3200 FSP1000 IP HVI GFK AL	105 330	175	SVK 7.10 7.10 FL30 V4A	308 229	81
SEIL 10.5 70Q CUGALSN R50M	832 202	23	SR D50 3200 FSP1000 IP HVI GFK V2A			SVK 7.10 7.10 FL40 STTZN	308 320	81
SEIL 12.5 95Q CU R50M	832 095	23		105 314	175	SVK 7.10 7.10 FL40 V4A	308 329	81
SEIL 12.5 95Q CUGALSN R50M	832 295	23	SR D50 3500 FS1000 IP SA HVIP GFK V2A			SVK 7.10 FL30 V4A	308 249	81
SEIL 14.5 120Q CU R50M	832 120	23		105 392	199	SVK FL30 STTZN	308 230	81
SEIL 14.5 120Q CUGALSN R50M	832 320	23	SR D50 3500 FS22 10 2500 IP HVIP GFK V2A			SVK FL30 V4A	308 239	81
Seil 7.5 CUGALSN 35Q R100M	832 838	23		105 321	198	SVPK 8.10 8.10 FL30 STTZN	308 060	82
SEIL 8 V4A R100M	850 008	22	SR D50 3500 FS2500 IA HVIP GFK AL	105 573	198	SVPK 8.10 8.10 FL30 ZP STTZN	308 070	82
SEIL 9 50Q AL R100M	840 050	22	SR D50 3500 FS2500 IA SA HVIP GFK AL					
SEIL 9 50Q CU R100M	832 740	23		105 543	199	TBM 10M SCFU STTZN AL	103 125	107
SEIL 9 50Q CU R50M	832 739	23	SR D50 3500 FS2500 IP SA HVIP GFK V2A			TBM 11M SCFU STTZN AL	103 126	107
SEIL 9 50Q CUGALSN R100M	832 839	23		105 393	199	TBM 13.35M FP400 STTZN	103 013	107
SGK ZS 7.10 KB3.13 CU	343 007	87	SR D50 3500 FSP1000 IA HVIP GFK AL	105 563	198	TBM 16.35M FP400 STTZN	103 016	107
SGK ZS 7.10 KB3.13 STTZN	343 000	87	SR D50 3500 FSP1000 IA SA HVIP GFK AL			TBM 19.35M FP565 STTZN	103 019	107
SH 16 BB16 V2A ZG	106 129	117		105 513	199	TBM 22.35M FP565 STTZN	103 022	107
SH BB16 L475 WS V2A STTZN	223 005	112	SR D50 3500 FSP1000 IP HVIP GFK V2A			TBM 24.85M FP565 STTZN	103 025	107
SH DFI 16 STTZN H42 GR	252 000	63		105 320	198	TBM 6M SCFU STTZN AL	103 121	107
SH KR 13.16 H28 B6.5 V2A	275 019	63	SR D50 4700 FS1000 IP SA HVI GFK AL			TBM 7M SCFU STTZN AL	103 122	107
SH ZS 16 AB D10X180 STTZN ZG	273 731	62		105 327	175	TBM 8M SCFU STTZN AL	103 123	107

Type	Part No.	Page	Type	Part No.	Page	Type	Part No.	Page
TBM 9M SCFU STTZN AL	103 124	107	UEL DQ 6.10 B8.5 V2A	202 001	49	VK EH R10 F30 V2A	308 129	137
TE 20 1000 AZ V4A	620 903	245	UFTSK 197X197X204 K	549 051	66	VM 16 SKM8X12 AL	385 216	89
TE 20 1000 Z STTZN	620 101	245	UFTSK 200X200X105 V2A	549 091	67	VM 7.10 SKM6X12 ZG	385 202	78
TE 20 1500 AZ V4A	620 902	245	UFTSK 300X220X120 GG	549 000	66	VM 8 SKM6X10 ZG	385 203	78
TE 20 1500 Z STTZN	620 151	245	UFTSK 7.10 FL40 197X197X204 K	549 050	66	VM 8 SKM6X8 AL	385 213	78
TE 25 1000 Z STTZN	625 101	245	UFTSK 7.10 FL40 200X200X105 V2A	549 090	67	VM 8 SKM6X8 CU	385 207	78
TE 25 1500 Z STTZN	625 151	245	UFTSK 7.10 FL40 300X220X120 GG	549 001	66	VS EX 500 V2A	275 498	187
TFS	923 023	276	UKSV 6.10 AQ16 50 V4A	540 122	51	VTK 5.10 FL30.40 ZP STTZN	454 000	93
TM 7.10 16 AL	450 001	93	ULP KS D280 SW	102 060	103	VTK 7.10 FL30.40 CU	454 107	92
TM 7.10 16 RG	450 007	93	ULP KS D370 SW	102 050	103	VTK 7.10 FL30.40 STTZN	454 100	92
TM 7.10 16 ZG	450 000	93	UNI FK 8.10 KBF0.7 8 AL V2A	365 250	274	VTK FL30 TGTZN	455 000	93
TM 8.10 8 AL	450 101	93	UTK 16 FL30 ZP V2A	459 159	92	WB D40 WA V2A	105 140	105
TM G 7.10 16 ZG	450 011	93	UTK 200 2X10 FL30 ZP V2A	459 200	94	WB D40.50 SE WA110 V2A	105 348	105
TS 16 FL30 PP V2A	490 021	70	UTK 200 8.10 16 ZP V2A	459 219	94	WB D40.50 SE WA46 V2A	105 342	105
TS 7.10 FL30 PP V2A	480 113	71	UTK 7.10 16 S ZP STTZN	459 000	91	WB D40.50 V150.200 V2A	105 344	106
TS 7.10 V1.0 1.15M STTZN	239 000	39	UTK 7.10 7.10 S ZP STTZN	459 003	91	WB D40.50 V230.400 STTZN V2A	105 347	106
TS 7.10 V1.25 1.40M STTZN	239 001	39	UTK 8.10 16 STTZN	459 010	92	WB D40.50 V400.700 STTZN V2A	105 343	106
TS 7.10 V1.25 1.55M V2A	239 009	39	UTK 8.10 16 V2A	459 019	92	WB D40.50 V700.1300 STTZN V2A	105 349	106
TS 7.10 V1.45 1.75M V2A	239 019	39	UTK 8.10 16 ZP V2A	459 119	91	WB D40.50 V700.1300 STTZN V2A	105 349	158
TSK 140X140 V2A AF8 10 L200 STTZN	476 010	67	UTK 8.10 8.10 STTZN	459 020	92	WB D50 WA V2A	105 340	124
TSK 140X140 V2A AL16CU	476 016	67	UTK 8.10 8.10 V2A	459 029	92	WB D60 V250.350 STTZN	105 345	171
TSK WDV5 180X140X88 K V2A	476 050	68	UTK 8.10 8.10 ZP CU	459 127	90	WD M10 12 V4A DWD L200 300 STTZN		
TSKS WDV5 185X140X88 AH50.200 K V2A	476 055	68	UTK 8.10 8.10 ZP V2A	459 129	90		478 530	131
			UTK 8.10 8.10 ZP V2A	459 129	221	WD M10 12 V4A DWD L300 400 STTZN		
			UTK 8.10 FL30 STTZN	459 030	92		478 540	131
			UTK 8.10 FL30 V2A	459 039	92	WD M10 12 V4A DWD L400 500 STTZN		
UEBB L180 B10.5 B5.2 AL	377 015	28	UTK 8.10 FL30 ZP V2A	459 139	91		478 550	131
UEBB L180 B10.5 B5.2 CU	377 007	28	UV 8.10 KTP V2A	315 119	76	ZMDRK DUL 8.10 W16.22 CU STTZN	339 157	86
UEBB L180 B10.5 B6.5 AL	377 045	29	V DBS RA320 PAE 20 V 600 1180 V2A	105 469	183	ZMDRK KB 6.10 W16.22 CU STTZN	339 167	86
UEBB L300 3XB10.5 B5.2 AL	377 115	29	V DBS RA320 PAE 27 V 600 1180 V2A	105 468	206	ZMFK KB 6.10 KBF0.7 8 CU STTZN	365 127	85
UEBB L300 3XB10.5 B5.2 CU	377 107	29	V DBS RA320 PAE 27 V 750 1510 V2A	105 467	206	ZMFK KB 6.10 KBF0.7 8 STTZN CU	365 117	85
UEBL L170 B11 B5.2 6.5 AL	377 006	28	VBS KB D50 HS RA1450 V2A	105 491	178	ZMMVK 6.8 FRM10X35 CU STTZN	390 267	74
UEBL L170 B11 B5.2 6.5 CU	377 027	28	VBS KB D50 HS RA600 V2A	105 490	178	ZMMVK 8 8.10 SKM10X30 CU AL	390 657	74
UEBL L170 B5.2 6.5 AL	377 016	28	VK 20.32 FL40 BSB STBL	308 037	137	ZMRRS 100 KB 6.10 CU STTZN	420 207	50
UEBL L220 B11 B5.2 6.5 AL	377 026	28	VK 6.10 FL30 FL30 BSB STTZN	308 026	135	ZMTK 6.10 FL30.40 CU STTZN	460 147	93
UEBS 16 L200 B10.5 B6.5 AL CU	377 210	29	VK 6.20 FL30 BSB STBL	308 032	137	ZMTK 8.10 16 CU STTZN	460 507	91
UEBS 16 L300 B10.5 B6.5 AL CU	377 310	29	VK 6.22 FL40 KB6.10 BSB STBL	308 035	131	ZMTK 8.10 8.10 CU STTZN	460 517	91
UEBS 16 L400 B10.5 B6.5 AL CU	377 410	29	VK A R22 F40 STBL	308 030	135	ZMTK 8.10 FL30 CU STTZN	460 557	91
UEBS 16 L400 CU FK0.7 10 V2A	365 419	30	VK A UNI ST	308 025	135	ZSUEL 16 2XM6 LA38 V2A	490 022	70
UEBS 16 L500 B10.5 B6.5 AL CU	377 510	29	VK DB 20.32 8.10 FL40 BSB STBL	308 036	137	ZSUEL 7.10 2XM6 LA38 AL	480 291	70
UEK 8.10 AQ3/4 M8 V4A	540 270	220	VK DB 6.20 8.10 FL30 BSB STBL	308 031	137	ZSW METREL A1018	578 352	289
UEK 8.10 AQ4 50 HKSM10 V2A	540 260	275	VK EH R10 F30 ST	308 120	137	ZSW METREL A1019	578 353	289
UEK 8.10 AQ4 50 HKSM8 V2A	540 250	275	VK EH R10 F30 ST	308 120	242			
UEL DQ 6.10 B6.5 V2A	202 169	49						
UEL DQ 6.10 B8.5 STTZN	202 000	49						

German Armed Forces – Stock Nos.

Part No.	Military Name	Stock No.	Page	Part No.	Military Name	Stock No.	Page	Part No.	Military Name	Stock No.	Page
307 000	VG 96953 T06 D0002	5999-12-158-2303	77	410 615	VG 96927 T011 A123	6150-12-308-6928	255	416 451	VG 96927 T011 A108	6150-12-308-6935	259
				410 630	—	6150-12-353-5887	255	416 505	VG 96927 T011 A124	6150-12-300-9131	258
308 041	—	5999-12-362-1557	75	410 720	VG 96927 T011 A127	6150-12-308-6979	260	416 516	VG 96927 T011 A125	6150-12-308-6607	256
				410 903	VG 96927 T011 A027	6150-12-198-1948	259	416 903	VG 96927 T011 A035	6150-12-198-6812	260
410 003	VG 96927 T011 A044	6150-12-156-9107	255	410 905	VG 96927 T011 A028	6150-12-198-6809	259	416 905	VG 96927 T011 A036	6150-12-198-6813	260
410 005	VG 96927 T011 A045	6150-12-156-8386	255	410 906	VG 96927 T011 A029	6150-12-198-6810	259	416 906	VG 96927 T011 A037	6150-12-198-6814	260
410 006	VG 96927 T011 A046	6150-12-156-9108	255	410 910	VG 96927 T011 A030	6150-12-198-1482	259	416 910	VG 96927 T011 A038	6150-12-168-9942	260
410 010	VG 96927 T011 A047	6150-12-156-8387	255	410 915	VG 96927 T011 A031	6150-12-168-2696	259	416 915	VG 96927 T011 A039	6150-12-168-2693	260
410 015	VG 96927 T011 A048	6150-12-156-9069	255	410 920	VG 96927 T011 A032	6150-12-168-2695	259	416 920	VG 96927 T011 A040	6150-12-198-6815	260
410 020	VG 96927 T011 A049	6150-12-156-9073	255	410 925	VG 96927 T011 A033	6150-12-168-2694	259	416 925	VG 96927 T011 A041	6150-12-198-6816	260
410 025	VG 96927 T011 A050	6150-12-156-9072	255	410 930	VG 96927 T011 A034	—	259	416 930	VG 96927 T011 A042	6150-12-198-1483	260
410 030	VG 96927 T011 A051	6150-12-156-9109	255					416 970	VG 96927 T011 A043	6150-12-168-2692	260
410 035	VG 96927 T011 A052	6150-12-156-9071	255	416 003	VG 96927 T011 A062	6150-12-156-9115	256				
410 040	VG 96927 T011 A053	6150-12-156-9070	255	416 005	VG 96927 T011 A063	6150-12-156-9085	256	417 005	—	6150-12-313-5059	257
410 050	VG 96927 T011 A054	6150-12-156-6051	255	416 006	VG 96927 T011 A064	6150-12-156-9116	256	417 010	—	6150-12-313-5060	257
410 060	VG 96927 T011 A055	6150-12-156-9110	255	416 010	VG 96927 T011 A065	6150-12-156-9084	256	417 015	—	6150-12-313-5061	257
410 070	VG 96927 T011 A056	6150-12-156-9111	255	416 015	VG 96927 T011 A066	6150-12-156-9117	256	417 020	—	6150-12-313-5062	257
410 099	VG 96927 T011 A057	6150-12-156-9112	255	416 016	VG 96927 T011 A128	6150-12-178-9673	260	417 030	—	6150-12-313-5063	257
410 140	VG 96927 T011 A058	6150-12-156-6207	255	416 020	VG 96927 T011 A067	6150-12-156-9118	256	417 050	—	6150-12-313-5064	257
410 150	VG 96927 T011 A059	6150-12-161-4272	255	416 025	VG 96927 T011 A068	6150-12-156-9119	256	417 100	—	6150-12-313-5065	257
410 199	VG 96927 T011 A060	6150-12-156-9113	255	416 030	VG 96927 T011 A069	6150-12-156-9083	256	417 115	—	6150-12-313-5066	257
410 299	VG 96927 T011 A061	6150-12-156-9114	255	416 035	VG 96927 T011 A070	6150-12-156-6208	256	417 120	—	6150-12-313-5067	257
410 401	VG 96927 T011 A092	6150-12-300-9132	258	416 040	VG 96927 T011 A071	6150-12-156-8388	256	417 125	—	6150-12-185-8587	257
410 403	VG 96927 T011 A093	6150-12-195-9490	258	416 050	VG 96927 T011 A072	6150-12-156-9120	256	417 130	—	6150-12-313-5068	257
410 404	VG 96927 T011 A094	6150-12-192-5455	258	416 060	VG 96927 T011 A073	6150-12-156-9082	256	417 150	—	6150-12-174-2744	257
410 405	VG 96927 T011 A085	6150-12-196-6346	258	416 070	VG 96927 T011 A074	6150-12-156-9121	256				
410 406	VG 96927 T011 A096	6150-12-192-5456	258	416 080	VG 96927 T011 A075	6150-12-188-4475	256	435 803	VG 96953 T06 B0001	5999-12-156-2656	262
410 407	VG 96927 T011 A086	6150-12-198-7027	258	416 100	VG 96927 T011 A076	6150-12-156-9122	256	435 805	VG 96953 T06 A0001	5999-12-156-9129	261
410 410	VG 96927 T011 A087	6150-12-171-2783	258	416 120	VG 96927 T011 A077	6150-12-188-4476	256				
410 411	VG 96927 T011 A097	6150-12-192-5457	258	416 140	VG 96927 T011 A078	6150-12-156-9123	256	444 006	VG 96933 T14 A002A	5940-12-156-9126	261
410 413	VG 96927 T011 A084	6150-12-196-7301	258	416 150	VG 96927 T011 A079	6150-12-161-4273	256	444 008	VG 96933 T14 B001A	5940-12-156-9128	261
410 415	VG 96927 T011 A098	6150-12-192-5458	258	416 200	VG 96927 T011 A080	6150-12-156-9124	256	444 009	VG 96933 T14 B002A	5940-12-156-9127	261
410 416	VG 96927 T011 A088	6150-12-198-1216	258	416 220	VG 96927 T011 A081	6150-12-188-4477	256	444 010	VG 96933 T14 A001A	5940-12-152-3867	261
410 420	VG 96927 T011 A099	6150-12-198-1217	258	416 280	VG 96927 T011 A082	6150-12-188-4478	256				
410 421	VG 96927 T011 A089	6150-12-198-1218	258	416 300	VG 96927 T011 A083	6150-12-156-9125	256	465 801	VG 96953 T07 A0001	5940-12-156-8385	263
410 425	VG 96927 T011 A100	6150-12-198-6803	258	416 410	VG 96927 T011 A102	6150-12-308-6941	259				
410 426	VG 96927 T011 A090	6150-12-198-6804	258	416 411	VG 96927 T011 A109	6150-12-308-6934	259	466 192	VG 96953 T07 B0001	5940-12-188-4931	263
410 430	VG 96927 T011 A101	6150-12-198-6805	258	416 415	VG 96927 T011 A110	6150-12-308-6981	259	466 203	VG 96953 T10 E0001	4030-12-320-9037	263
410 431	VG 96927 T011 A091	6150-12-198-6806	258	416 416	VG 96927 T011 A103	6150-12-308-6940	259				
410 450	VG 96927 T011 A095	6150-12-197-0088	258	416 420	VG 96927 T011 A111	6150-12-308-6933	259	540 100	VG 96953 T05 B0002	5975-12-120-7744	262
410 503	VG 96927 T011 A116	6150-12-196-7302	257	416 421	VG 96927 T011 A104	6150-12-308-6939	259	540 103	VG 96953 T05 B0001	—	262
410 506	VG 96927 T011 A117	6150-12-195-9694	257	416 425	VG 96927 T011 A112	6150-12-308-6932	259	540 110	VG 96953 T05 BA001	—	262
410 510	VG 96927 T011 A118	6150-12-196-7304	257	416 426	VG 96927 T011 A105	6150-12-309-6938	259	540 901	VG 96953 T05 BB001	—	120
410 515	VG 96927 T011 A119	6150-12-196-7303	257	416 430	VG 96927 T011 A113	6150-12-308-6931	259				
410 520	VG 96927 T011 A120	6150-12-196-7606	257	416 431	VG 96927 T011 A106	6150-12-308-6937	259	634 145	VG 96953 T10 D0003	5975-12-382-6412	263
410 525	VG 96927 T011 A121	6150-12-198-6807	257	416 440	VG 96927 T011 A114	6150-12-308-6930	259	634 160	VG 96953 T10 D0004	—	263
410 530	VG 96927 T011 A122	6150-12-198-6808	257	416 441	VG 96927 T011 A107	6150-12-308-6936	259				
410 606	VG 96927 T011 A126	6150-12-304-4604	260	416 450	VG 96927 T011 A115	6150-12-308-6929	259	644 000	VG 96953 T10 A0001	5975-12-120-0006	261

Key Words

Product	Page	Product	Page	Product	Page
Air-termination Mast for Sub-roof Installation of the HVI Conductor	160	Connecting Clamps for Foundation Earth Electrodes and Reinforcements	137/242	Earth Resistance Meter MI 3123	289
Air-termination Mast for Sub-roof Installation of the HVI light Conductor	159	Connecting Clamps for Reinforcements	134/240	Earth Rods	245
Air-termination Masts for HVI light Conductors on Flat Roofs	145	Connecting Components	94/188/211	End Pieces	132/235
Air-Termination Mast with HVI Conductor	171	200 kA (10/350 µs)	94/188/211	EP4 Continuity Tester	290
Air-termination Mast with HVI power Conductor	196	Connecting / Disconnecting Clamps	92	Equipotential Bonding Busbar MS	265
Air-Termination Rod Adapter	112	Connecting Sleeve for Air-Termination Rods	89	Equipotential Bonding Busbars for Ex Zone 2/22	282
Air-Termination Rod for Ridge and Hip Tiles	110	Connecting Sleeves	78	Equipotential Bonding Busbars Industry	268
Air-Termination Rod for Trapezoidal Roofs	110	Connection Brackets	87/247	Equipotential Bonding Busbars K12 with Snap-on Terminals	265
Air-Termination Rods D40	101	Connection Clamps	82/248/278	Equipotential Bonding Busbars R15 with Terminal Block System / Kit	266
Air-Termination Rods for Metal Roofs	109	Connection Clamps for Steel Girders	83	Equipotential Bonding Busbar with Miniature Terminal Block System	265
Air-Termination Rods GRP/Al	121	Connection Clamps with Threaded Bolt	133/236	Equipotential Bonding on Cable Tray Systems for Ex Zone 2/22	284
Air-Termination Rods / Tips	95	Connection Clamps with Thrust Piece	83	ES Disconnecting Clamp	76
Air-Termination Stud	113	Connection Element for DEHNcon-H, HVI Conductor	161	EXFS 100 / EXFS 100 KU	286
Air-Termination Tips	113	Connection Element for DEHNcon-H, HVI light Conductor	160	EXFS L / EXFS KU	286
Anchoring Pole	263	Connection Elements for DEHNcon-H, HVI light Conductor	157	Expansion Pieces	27
Anchors for Rigid Foam Boards	55/65	Connection Elements for HVI light Conductors	144	Expansion Strap for Foundation Earth Electrodes	244
Angled Air-Termination Tips	112	Connection Elements for HVI long Conductor	173	Fixed Earthing Terminal M16	130/234
Antenna Earthing	272	Connection Elements for HVI power Conductor / HVI power long Conductors	198	Fixed Earthing Terminals	129/233
Antenna Earthing – Telecommunication Systems	262	Connection Kit for Safety Rope System	30	Fixing Elements for Supporting Tubes	179/202
Anti-Corrosion Tape	294	Connectors	76	FIX Test Joint	66
Bimetallic Disconnecting Clamp with Shield	93	Cover Discs and Plastic Bases	48	Flat Strip Holders DEHNhold	53/63
Blind Rivet	30	Cross Units for Aboveground and Underground Connections	79	Flat Strip Holders with Clamping Plate and Flange	54/64
Bridging Brackets	28	Cross Units for Aboveground Connections	78	Flat Strip Holders with Clamping Plate – Flat Design	53/64
Bridging Braids	28	Cross Units with Truss Head Screws for Aboveground and Underground Connections	80	Flat Strip / Round Conductor Holders with Thrust Piece	54/64/278
Bridging Cables	29	CUI Conductor	218	Flush-mounted Conductor Holder	49
Bridging Cable with Seam Clamps	30	Cupal Sheets	90	Flush-mounted Conductor Holders/Saddle Clamps	49
Bucket Foundations for Telescopic Lightning Protection Masts	108	Cupal Sleeves	90	Foundation Basket for On-site Concrete Foundations	108
Cables	22/228	DEHNclip Rebar Clamp	134/239	FS Clamps (Air-termination Rod Clamps)	88
Cable shears for HVI Conductors	151/165/190/212	DEHNcon-H	156	Gutter Clamps	86
Carrier Plate for VDB Test Badge	71	DEHNcon-H Supporting Tube for HVI Conductor, Sub-roof Installation	160	Gutter Clamps with Single-screw Technique	85
Case with Measuring Accessory for Continuity Tester	291	DEHNcon-H Supporting Tube for HVI light Conductor, Sub-roof Installation	159	Hammer Frame	253
Clamping Piece	88	DEHNcon-H Supporting Tubes for HVI light Conductor	157	Hammer Inserts for Earth Rods	249
Clamping Piece Variants	51/75	DEHNiso Combi Sets	123	Hammer Inserts for Tubular Earth Rods	251
Clamping Shoes	88	DEHNiso Roof Conductor Holders	122	Hammer Support	253
Clamps for Ex Zone 2/22	281	DEHNiso Spacers	115	Heat-Shrinkable Sleeve	294
Components for Buildings with Thatched Roof	39	DEHNIT Earthing Method	229/246	Holders for Air-Termination Systems on Ridge and Hip Tiles	111
Concrete bases	102	Disconnecting Clamp – Austrian Standard	92	HVI Conductor / HVI long Conductor	160/172
Conductor Holder	278	Disconnecting Sleeves	93	HVI light Conductor	144/156/159
Conductor Holder for Installation on Gable Roofs and Metal Roofs	163	Downpipe Clamps	50/276	HVI power Conductor	197
Conductor Holders and Accessories for Installation on Flat Roofs / Metal Roofs	147	Drilling Screw	29	Inspection Doors	68
Conductor Holders DEHNfix	46	Dripping Water Protective Collars	21	Isolating Spark Gaps	276
Conductor Holders DEHNgrip	45	Driving Heads	252	KS Connectors	51/75
Conductor Holders DEHNhold	46/59	Driving Spikes	245	Lightning Protection Earthing Pipe Clamps	273
Conductor Holders DEHNSnap	45	Earth Entry Rods	57/230	Lightning Protection Pipe Clamp with Tines	273
Conductor Holders for CUI Conductor	218	Earth Entry Rod Set	57/229	Lightning Strike Counter	55/292
Conductor Holders for Downpipes	50	Earthing Busbars	263	Marker for Connection Lugs	21/59/231
Conductor Holders for External Thermal Insulation Composite Systems	49/61	Earthing Cable Lugs	261	MAXI MV Clamps	75
Conductor Holders for HVI Conductor in Ex Areas	186	Earthing Cables with Cable Lug / Pin Cable Lug	260	MMV Clamps	74
Conductor Holders for HVI power Conductors in Ex Areas	209	Earthing Cables with closed Cable Lugs	259	Mounting Bracket for Air-Termination Systems on Metal Roofs	104/161
Conductor Holders for Service Entry Masts	276	Earthing Cables with open Cable Lugs	255	Mounting Bracket for Installation on Rafters	161
Conductor Holders with Saddle Clamp and Flange	47/60	Earthing Cables with open / closed Cable Lugs	257	MV Clamps	73
Conductor Holders with Saddle Clamp and Pin	48	Earthing Clamps	261	MV Clamps for Air-Termination Rods	89
Conductor Holder with Claw	49	Earthing Pipe Clamps	271		
Conductor Holder with Saddle Clamp – Flat Design	47/60	Earthing Pipe with Drilling Spiral	263		
Connecting Clamps for Fixed Earthing Terminals and Reinforcement	131/234	Earthing Pipe with Driving Spike	246		
Connecting Clamps for Foundation Earth Electrodes	137/242	Earthing Spikes	263		
		Earthing Tongs	277		
		Earth Resistance Measuring Equipment in a Case	291		
		Earth Resistance Meter GEOHM C	289		
		Earth Resistance Meter Metraclip Earth	290		

Key Words

Product	Page	Product	Page	Product	Page
Number Plates	71	Roof Conductor Holders with Embossed Brace for Roof Surfaces	34	SV Clamps for Aboveground and Underground Connections	81/243
Parallel Connectors	77	Roof Conductor Holders with Preformed Brace for Roof Surfaces	38	SV Clamps for Underground Connections	81/243
Parallel Connectors for Ex Zones 1/21, 2/22	280	Roof Conductor Holders with Tension Spring for Ridge and Hip Tiles	31	SVP Clamps for Aboveground and Underground Connections	82
Pipe Clamp for Air-Termination Rods	112	Round Wires	19/225	Telescopic Lightning Protection Mast for Bucket or Concrete Foundations	107
Pipe Clamp GSG for Ex Zone 2/22	280	Saddle Clamps with Enlarged Contact Surface	85	Telescopic Lightning Protection Mast with Screw Foundation	107
Pipe Clamps for Ex Zones 1/21, 2/22	279	Sealing Collar for Connection Lug	131/237	Test Joint Boxes	67
Pipe Clamps for Service Entry Masts	276	Seam Clamps	84	Test Joint Box for External Thermal Insulation Composite Systems	68
Plastic base plates	103	Self-supporting Air-Termination Rods 2.5 to 3.5 m	97	Threaded Adapter	133/236
Plastic Conductor Holders for Downpipes	52	Self-supporting Air-Termination Rods 4 to 9 m	98	Tripod for Supporting Tubes without Side Outlet	177
Potential Grading	220	Self-supporting Air-Termination Rods 10 and 11 m	99	Tripods for Air-Termination Rods D40 and Supporting Tubes GRP/Al	102
Profiled Earth Rods	246	Self-supporting Air-Termination Rods 12 to 14 m	100	Tripods for Supporting Tubes without Side Outlet	199
Protective Spark Gap	275	Sign	219	Tripods for Supporting Tubes with Side Outlet	178/201
Rod Clamps	89	Single-Row Earthing Busbars	269	Tubular Earth Rods	246
Rod Holder for Gable Roofs	112	Single-screw Connection Clamps	247	Two-Row Earthing Busbars	270
Rod Holders DEHNfix	63	Snow Guard Clamps	87	Two-Screw Clamp	71
Rod Holders DEHNhold	61/97	Spacers	244	UF Test Joint Boxes	66
Rod Holders for External Thermal Insulation Composite Systems	62	Spacers for Omnidirectional Antennas	181/204	UNI Disconnecting Clamps	90
Rod Holders with Clamp and Pin	62	Spider Wrench	294	UNI Earthing Clamps	275
Rod Holders with Saddle Clamp and Flange	62	Staples	53/65	UNI Saddle Clamp	274
Rod Holders with Claw	63	Staples for Flat Strips	55/65	Universal Connector	76
Rod Bushings	27	Straightened / Angled Connection Lugs	58/231	Variable Number Plates	69
Roof Conductor Holders Adjustable for Ridge and Hip Tiles	32	Straightening Tool	293	Wall Bushings	130/237
Roof Conductor Holders for Corrugated Sheet Roofs	43	Stripping Tool for CUI Conductors	219	Wall-Mounted Conductor Holders	150/164
Roof Conductor Holders for Flat Roofs	25	Stripping tool for HVI light Conductors / HVI Conductors 150/151/164/165/189/190	212	Water Pressure-tight Wall Bushings for White Tank	237/131
Roof Conductor Holders for Flat Roofs with Fixing Holes	26	Stripping Tool for HVI power Conductors	212	Wedge Connector	244
Roof Conductor Holders for Metal Roofs	41	Strips	21/227	Wire Straighteners	293
Roof Conductor Holders for Ridge and Hip Tiles	33	Supporting Tubes for HVI long Conductor	175	Wood Screws with Threaded Head	55/65
Roof Conductor Holders with Adhesive Pad	42	Supporting Tubes for HVI power Conductor / HVI power long Conductors	198		
Roof Conductor Holders with Angled Brace for Roof Surfaces	36	Supporting Tube with HVI Conductor	170		
Roof Conductor Holders with Angled, Flexible Brace for Roof Surfaces	33	Supporting Tube with HVI power Conductor	196		
Roof Conductor Holders with Brace for Roof Surfaces	36	Supports for Air-Termination Rods D40 and DEHNcon-H	105		
Roof Conductor Holders with Clamping Device for Roof Surfaces	37				

Notes

Since we do not plan systems or parts of systems, our product recommendations should be regarded as product information and for advisory purposes only. Our oral and written application proposals are based on experience and are specified to the best of our knowledge. We do not accept any liability in this respect. This particularly applies to the different conditions of use which are beyond our control. We recommend checking whether the respective DEHN product is suitable for the intended application. Application, use and processing of our products are beyond our control and therefore the product is completely subject to the responsibility of the user.

Illustrations are not binding.

We accept no liability for misprints, modifications and errors.

*) GTIN (EAN code)

In the catalogue, you will find the GTIN (EAN code) next to the Part No. For reasons of clarity, only the individual GTIN part is specified.

The country and DEHN code (40 13364) must be put in front of this number.

Abbreviations:

PG	Product Group
PU	Packing Unit
SU	Sales Unit (Piece, Meter, Set or Pair)
Pc(s)	Piece(s)
m	Meter
Pa	Pair
Weight	Weight per sales unit

Classification	Title
IEC 62305-1 (EN 62305-1):2010-12	Protection against lightning Part 1: General principles
IEC 62305-2 (EN 62305-2):2010-12	Protection against lightning Part 2: Risk management
IEC 62305-3 (EN 62305-3):2010-12	Protection against lightning Part 3: Physical damage to structures and life hazard
IEC 62305-4 (EN 62305-4):2010-12	Protection against lightning Part 4: Electrical and electronic systems within structures

Standard	Supplement	Title
DIN EN 62305-2	1	Lightning threat in Germany
	2	Calculation assistance for assessment of risk for structures
	3	Additional information for the application of DIN EN 62305-2 (VDE 0185-305-2)
DIN EN 62305-3	1	Additional information for the application of DIN EN 62305-3 (VDE 0185-305-3)
	2	Additional information for special structures
	3	Additional information for the testing and maintenance of lightning protection systems
	4	Use of metallic roofs in lightning protection systems
	5	Lightning and overvoltage protection for photovoltaic power supply systems
DIN EN 62305-4	1	Sharing of the lightning current

Classification	Title
IEC 62561-1 (EN 0185-561-1)	Protection against lightning Part 1: Requirements for connection components
IEC 62561-2 (EN 0185-561-2)	Protection against lightning Part 2: Requirements for conductors and earth electrodes
IEC 62561-3 (EN 0185-561-3)	Protection against lightning Part 3: Requirements for isolating spark gaps
IEC 62561-4 (EN 0185-561-4)	Protection against lightning Part 4: Requirements for conductor fasteners
IEC 62561-5 (EN 0185-561-5)	Protection against lightning Part 5: Requirements for earth electrode inspection housings and earth electrode seals
IEC 62561-5 (EN 0185-561-6)	Protection against lightning Part 6: Requirements for lightning strike counters
IEC 62561-5 (EN 0185-561-7)	Protection against lightning Part 7: Requirements for earthing enhancing compounds
IEC TS 62561-8 Edition 1.0 2018-01	Protection against lightning Part 8: Requirements for components for isolated LPS

Conversion Table

Description	Part No.	Length	Weight	Weight	Length
Round Wire St/tZn , 8 mm	800 008	1 m	393 g	1 kg	2.54 m
Round Wire St/tZn , 10 mm	800 010/800 310	1 m	617 g	1 kg	1.62 m
Round Wire St/tZn , with PVC sheath, 8 mm	800 108	1 m	440 g	1 kg	2.30 m
Round Wire St/tZn , with PVC sheath, 10 mm	800 110	1 m	680 g	1 kg	1.48 m
Round Wire Al , semi-rigid/soft, 8 mm	840 008/840 018 840 108/840 028	1 m	135 g	1 kg	7.40 m
Round Wire StSt (V2A)/(V4A) , 8 mm	860 008/860 908	1 m	395 g	1 kg	2.54 m
Round Wire StSt (V2A)/(V4A) , 10 mm	860 010/860 020 860 910/860 920	1 m	617 g	1 kg	1.62 m
Round Wire Cu , semi-rigid/soft, 8 mm	830 008/830 108 830 038	1 m	448 g	1 kg	2.22 m
Strip St/tZn , 20 x 2.5 mm, Z500	810 225	1 m	400 g	1 kg	2.50 m
Strip St/tZn , 30 x 3.5 mm, Z500	810 335/852 335	1 m	840 g	1 kg	1.19 m
Strip St/tZn , 30 x 4 mm, Z500	810 304	1 m	960 g	1 kg	1.04 m
Strip St/tZn , 40 x 4 mm, Z500	810 404	1 m	1.280 kg	1 kg	0.78 m
Strip St/tZn , 40 x 5 mm, Z500	810 405	1 m	1.600 kg	1 kg	0.63 m
Strip StSt (V2A)/(V4A) , 30 x 3.5 mm	860 335/860 325 860 900/860 925 861 325/861 335	1 m	825 g	1 kg	1.21 m
Strip StSt (V4A) , 40 x 4 mm	860 404	1 m	1.248 kg	1 kg	0.80 m
Strip StSt (V4A) , 40 x 5 mm	860 405	1 m	1.560 kg	1 kg	0.64 m
Strip Cu , 20 x 2.5 mm	831 225	1 m	450 g	1 kg	2.22 m

Abbreviations

The following list shows and explains all abbreviations mentioned.

Conductor types:

Abbreviation	Conductor types
Fl	Flat conductor (strip)
Rd	Round conductor (round wire)

Materials:

Abbreviation	Description
Al	Aluminium
AlMgSi	Aluminium magnesium silicon wrought alloy
Cu	Copper, electrical copper
Cu/bronze	Copper / Bronze
Cu/gal Sn	Copper, tin-coated
EVA	Ethylene vinyl acetate copolymer
GRP	Glass-fibre reinforced plastic
GCI	Grey cast iron
K	Plastic material / Polyethylene / Polyamide / Polystyrene
Ms	Brass
Ms/gal Cu	Brass, copper-coated
Ms/gal Sn	Brass, tin-coated
StSt	Stainless steel Material No.: 1.4301 (material No.: ASTM/AISI 304) Material No.: 1.4303 (material No.: ASTM/AISI 305) Material No.: 1.4307 (material No.: ASTM/AISI 304L)
StSt (V4A)	Stainless steel Material No.: 1.4401 (material No.: ASTM/AISI 316) Material No.: 1.4404 (material No.: ASTM/AISI 316L) Material No.: 1.4571 (material No.: ASTM/AISI 316Ti)
StSt / gal Cu	Stainless steel, copper-coated
PA	Polyamide
PC	Polycarbonate
PE	Polyethylene
PP	Polypropylene
PS	Polystyrene
PVC	Polyvinyl chloride
ABS	Acrylonitrile butadiene styrene
Sn	Tin
St/bare	Steel (black)
St/gal Zn	Steel, galvanised
St/tZn	Steel, hot dip galvanised
St / Cu	Steel, copper-coated
MCI	Malleable cast iron
MCI/tZn	Malleable cast iron, hot dip galvanised
UP	Polyester (unsaturated)
XLPE	Cross-linked polyethylene
ZDC	Zinc die casting







Possible material combinations for air-termination systems, down conductors and other construction components.

Provided that no especially aggressive environmental influences have to be considered, the material combinations listed below have proved themselves. This is based on practical experience.

	Steel	Aluminium	Copper	StSt	Titanium	Tin
Steel (St/tZn)	yes	yes	no	yes	yes	yes
Aluminium	yes	yes	no	yes	yes	yes
Copper	no	no	yes	yes	no	yes
StSt	yes	yes	yes	yes	yes	yes
Titanium	yes	yes	no	yes	yes	yes
Tin	yes	yes	yes	yes	yes	yes

Symbols:





Screws	
	Half-round wood screw
	Countersunk head wood screw
	Wood screw with threaded head
	Cheese head screw
	Truss head screw
	Knurled screw
	Flat head screw
	Rounded head screw

Screw heads	
	Slot
	Hexagon
	Hexagon with slot
	Cross recessed
	Star drive
	Combined slot

Recommended values:

Screw	Tightening torque
M5 / M6	≥ 4 Nm
M8	≥ 10 Nm
M10	≥ 20 Nm
M12	≥ 25 Nm
M16	≥ 25 Nm

Miscellaneous:

Symbols	
	Test according to EN 62561-1 Please find more information on our website.
	Installation instructions See DEHN websites
	New products
	Discontinued products
	Wind load calculation according to Eurocode 1 (DIN EN 1991-1-4 + DIN EN 1991-1-4/NA)

Surge Protection
Lightning Protection
Safety Equipment
DEHN protects.

DEHN SE + Co KG
Hans-Dehn-Str. 1
92318 Neumarkt
Germany

Phone +49 9181 906-0
Fax +49 9181 906-1100
sales@dehn.de
www.dehn-international.com



Technical changes, misprints and errors excepted.
The pictures are not binding.